

# **Northeastern Illinois ITS Deployment Plan Update**

## **Addendum to Final Report**

Prepared by:

**Chicago Area Transportation Study  
Advanced Technology Task Force (ATTF)**

With Support of:

**PARSONS TRANSPORTATION GROUP**  
Consensus Systems Technologies  
National Engineering Technology (NET)

June 17, 2005

(This page left intentionally blank.)

## **Contents**

This Addendum contains the following two appendices to the Final Report:

3 - Mappings of Projects to Regional ITS Architecture

6 - Missing Interfaces per Gap Analysis

### ***Appendix 3: Mappings of Projects to Regional ITS Architecture***

This appendix maps the ITS Plan Update projects to the Regional ITS Architecture. These mappings provide an initial link between project descriptions as they are currently understood and the existing Regional ITS Architecture. In some cases, the project definitions imply interfaces (or even elements) that are not in the current architecture. These cases have been noted in the text describing each mapping and constitute a set of needed changes to the Regional ITS Architecture.

Each project mapping includes the following information:

- Title, project ID number, and short description of the project
- ITS Market Packages covered by the project
- Elements of the Regional ITS Architecture involved in the project
- Interfaces and information flows that make up the project. Note that in some cases the project has not been sufficiently defined to enable the definition of detailed interfaces. It should also be noted that because the mappings represent information flows and interfaces, they do not represent physical connections.

## **Table of Contents**

Appendix 3: Mappings of Projects to Regional ITS Architecture .....	ii
A3-1 CDOT Projects.....	1
A3-2 Cook County Projects.....	21
A3-3 DuPage County Projects.....	26
A3-4 Kane County Projects.....	31
A3-5 Lake County Projects.....	35
A3-6 McHenry County Projects .....	40
A3-7 Will County Projects.....	44
A3-8 IDOT Projects.....	49
A3-9 ISTHA Projects.....	69
A3-10 RTA Projects .....	77
A3-11 CTA Projects .....	91
A3-12 Metra Projects.....	98
A3-13 Pace Projects.....	102

## **List of Figures**

Figure A3-1: Development of Chicago TMC (ID 2)- Roadside Interface..... 2

Figure A3-2: Development of Chicago TMC (ID 2)- Traffic Management Interfaces..... 2

Figure A3-3: Development of Chicago TMC (ID 2)- Emergency and Maintenance  
Interfaces..... 3

Figure A3- 4: O’Hare Airport Satellite TMC (ID 3) – Traffic Management Interfaces..... 5

Figure A3- 5: Cicero Ave Smart Corridor ATMS Project (ID 4)..... 6

Figure A3-6: Cicero Ave Smart Corridor ATIS (ID 5) ..... 7

Figure A3- 7: CDOT Smart Corridors: Pulaski Road, etc. (ID 6) ..... 8

Figure A3-8: Museum Campus Transportation System (Cook/Chicago) (ID 7)..... 9

Figure A3-9: Chicago HTMS (ID 8) ..... 10

Figure A3-10: CDOT Field Devices (ID 10)..... 11

Figure A3-11: City of Chicago Interconnects..... 12

Figure A3-12: CDOT Fleet AVL (ID 12)..... 13

Figure A3-13: Chicago Skyway Travel Monitoring and Integration with IDOT Gateway  
(ID 13)..... 14

Figure A3-14: US 41 Lake Shore Drive information system (ID 14) ..... 15

Figure A3-15: Chicago Truck Route Advisory System (ID 15)..... 16

Figure A3-16: Chicago Special Event Advisory System (ID 16)..... 17

Figure A3-17: Chicago Arterial Congestion Advisory System (ID 17) ..... 18

Figure A3-18: Parking Information Projects (ID 18) ..... 19

Figure A3-19: Cook County TMC- Roadside Equipment Interfaces ..... 21

Figure A3-20: Cook County TMC- Traffic Management Interfaces..... 22

Figure A3-21: Cook County TMC- Emergency Management Interfaces ..... 22

Figure A3-22: Cook County Lake- Cook Travel Demonstration Project (ID 20)..... 23

Figure A3-23: Cook County Field Devices (ID 21) ..... 24

Figure A3-24: Cook County Fleet AVL (ID 22) ..... 25

Figure A3-25: Interagency Signal Coordination- Cook County (ID 23)..... 26

Figure A3-26: DuPage Emergency Management and Signal Preemption (ID 25)..... 28

Figure A3-27: DuPage County Paratransit Coordination (ID 26) ..... 29

Figure A3-28: Interagency Signal Coordination- DuPage County (ID 27)..... 30

Figure A3-29: Kane County Traffic Management Center-Roadside Interfaces (ID 28).. 31

Figure A3-30: Kane County Traffic Management Center-Emergency Management  
Interfaces (ID 28)..... 32

Figure A3-31: Kane County Traffic Management Center-Traffic Management Interfaces  
(ID 28)..... 32

Figure A3-32: Kane County Field Devices (ID 29)..... 33

Figure A3-33: Kane County Signal Interconnects (ID 30)..... 34

Figure A3-34: Lake County Traffic Management Center- Roadside Interfaces (ID 31) . 36

Figure A3-35: Lake County Traffic Management Center- Traffic Management Interfaces  
(ID 31)..... 37

Figure A3-36: Lake County Traffic Management Center- Emergency Management  
Interfaces (ID 31)..... 37

Figure A3-37: Lake County Field Devices (ID 32)..... 38

Figure A3-38: Lake County Signal Interconnects (ID 33) ..... 39

Figure A3-39: McHenry County Traffic Management Center- Roadside Interfaces (ID 34) ..... 40

Figure A3-40: McHenry County Traffic Management Center- Traffic Management Interfaces (ID 34) ..... 41

Figure A3-41: McHenry County Traffic Management Center- Emergency Management Interfaces (ID 34) ..... 41

Figure A3-42: McHenry County Field Devices (ID 35)..... 42

Figure A3-43: McHenry County Signal Interconnects (ID 36)..... 43

Figure A3-44: Will County Traffic Management Center-Roadside Interface (ID 37) ..... 44

Figure A3-45: Will County Traffic Management Center-Traffic Management Interfaces (ID 37)..... 45

Figure A3-46: Will County Traffic Management Center-Emergency Management Interfaces (ID 37) ..... 45

Figure A3-47: Will County Field Devices (ID 38)..... 47

Figure A3-48: Will County Signal Interconnects (ID 39) ..... 48

Figure A3-49: Integration of Centers (ID 41)..... 49

Figure A3-50: Interagency Operations and Signal Coordination (ID 42) ..... 51

Figure A3-51: Suburban Chicago ATMS - Centralized Traffic Control (ID 44) ..... 52

Figure A3-52: CCTV Surveillance Sharing (ID 48)..... 53

Figure A3-53: IDOT CCTV Systems Expressway (ID 49) ..... 54

Figure A3-54: Integrated Expressway/ Arterial Corridors (ID 50) ..... 55

Figure A3-55: Expressway Traffic Diversion Demo (ID 51)..... 56

Figure A3-56: Automatic Crash Notification (ACN) to PSAPs (ID 52)..... 57

Figure A3-57: Regionwide Emergency Traffic Operations Systems (ETOS) Upgrade (ID 53) ..... 58

Figure A3-58: IDOT District 1 DMS Deployment (ID 54)..... 59

Figure A3-59: GATEWAY Traveler Information System, Phase II (ID 55)- traffic management, transit and 511 interfaces..... 60

Figure A3-60: GATEWAY Traveler Information System, Phase II (ID 55) - emergency management interfaces..... 60

Figure A3-61: Statewide 511 Service (ID 56) ..... 61

Figure A3-62: HAR System Coordination (ID 57)..... 63

Figure A3-63: IDOT HAR System Enhancement (ID 58) ..... 64

Figure A3-64: Accident Database and Reporting System (ID 59) ..... 65

Figure A3-65: Railroad Grade Crossing Delay - Traveler Information System (ID 64).. 66

Figure A3-66: ITS Planning Database (ID 65)..... 67

Figure A3-67: ISTHA Fleet AVL (ID 67)..... 69

Figure A3-68: ISTHA Kiosks (ID 68)..... 70

Figure A3-69: ISTHA TIMS Enhancement (ID 69)..... 71

Figure A3-70: ISTHA Portable Queue Detection Systems (ID 70) ..... 72

Figure A3-71: ISTHA CCTV Coverage (ID 71)..... 73

Figure A3-72: ISTHA Systemwide Open Road Tolling (ORT) (ID 72) ..... 74

Figure A3-73: ISTHA DMS Deployment (ID 73)..... 75

Figure A3-74: Figure A3-74: ISTHA DMS Deployment (ID 74).....76

Figure A3-75: Transit Hub: APTS (ID 75)- Primary Service Board Center Interfaces ... 79  
Figure A3-76: Transit Hub: APTS (ID 75)- Traveler Interface Device Interfaces..... 80  
Figure A3-77: Transit Hub: APTS (ID 75)-Regional Transportation System Interfaces. 81  
Figure A3-78: Transit Hub: APTS (ID 75)- Miscellaneous Interfaces..... 82  
Figure A3-79: RTA Demo Projects- APTS (ID 76) ..... 83  
Figure A3-80: Illinois Transit Hub: ATIS (ID 77) ..... 84  
Figure A3-81: RTA Demo Projects: ATIS- BusInfo Initiative (ID 78a)..... 86  
Figure A3-82: RTA Demo Projects: ATIS- Regional Traveler Info Kiosks (ID 78b) ..... 86  
Figure A3-83: RTA Projects: ATIS- RTA Multi-Modal Trip Planner (ID 78c) ..... 87  
Figure A3-84: RTA Projects: ATIS- ATSS (ID 78d)..... 88  
Figure A3-85: RTA Projects: ATIS- Info Trans (ID 78e) ..... 88  
Figure A3-86: RTA Projects: ATIS- Parking Management Guidance Systems (ID 78f) 89  
Figure A3-87: RTA Projects: Transit Vehicle Safety Projects (ID 79) ..... 90  
Figure A3-88: Automatic Train Supervision (ATS) System (ID 80) ..... 91  
Figure A3-89: Train Passenger Information System (ID 81) ..... 92  
Figure A3-90: CTA Paratransit AVL/MDT (ID 82)..... 93  
Figure A3-91: CTA Hub Enhancements (ID 83)..... 94  
Figure A3-92: CTA Automatic Passenger Counter System (ID 84) ..... 95  
Figure A3-93: CTA AVL Upgrade (ID 85)..... 95  
Figure A3-94: CTA AVM Initiative (ID 87).....96  
Figure A3-95: CTA Archive (ID 88)..... 97  
Figure A3-96: Metra Rail Dispatch & Signaling System Upgrade (ID 89) ..... 98  
Figure A3-97: PIDS Modernization (ID 90)..... 99  
Figure A3-98: Metra TIMS Enhancements (ID 92) ..... 100  
Figure A3-99: Constant Time Warning at Grade Crossings (ID 93)..... 101  
Figure A3-100: Pace Intelligent Bus System (ID 94)..... 102  
Figure A3-101: Pace Paratransit MDT/AVL (ID 95) ..... 103  
Figure A3-102: Pace Hub Enhancement (ID 96)..... 104  
Figure A3-103: Pace Transit Operations Decision Support System (ID 97)..... 105  
Figure A3-104: Regionwide Transit Signal Priority Deployment (ID 100)..... 107



## **A3-1 CDOT Projects**

### **A3-1.1 Development of Chicago Traffic Management Center (ID 2)**

The Chicago TMC is one of the largest and most significant ITS projects being undertaken by CDOT (jointly with City of Chicago Office of Emergency Management and Communications). The TMC will be used to provide the following ITS Market Packages:

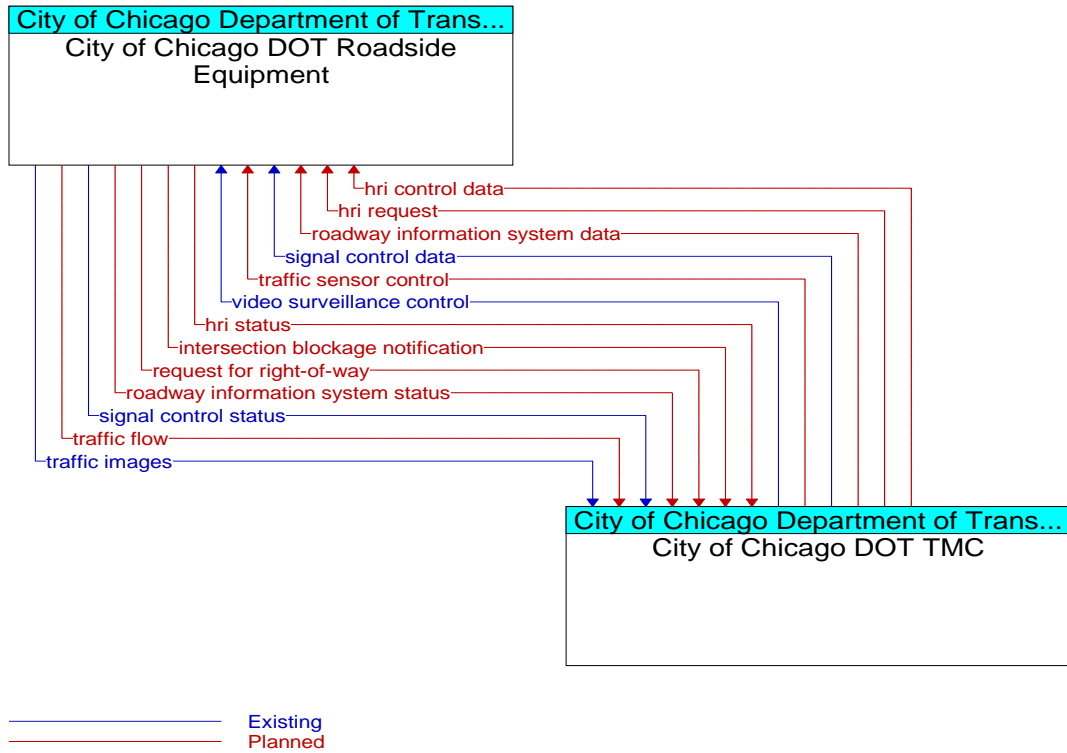
- Network Surveillance (ATMS01)
- Surface Street Control (ATMS03)
- Traffic Information Dissemination (ATMS06)
- Regional Traffic Control (ATMS07)
- Incident Management (ATMS08)
- Standard Railroad Grade Crossing (ATMS13)

The elements from the Regional ITS Architecture involved in this project are:

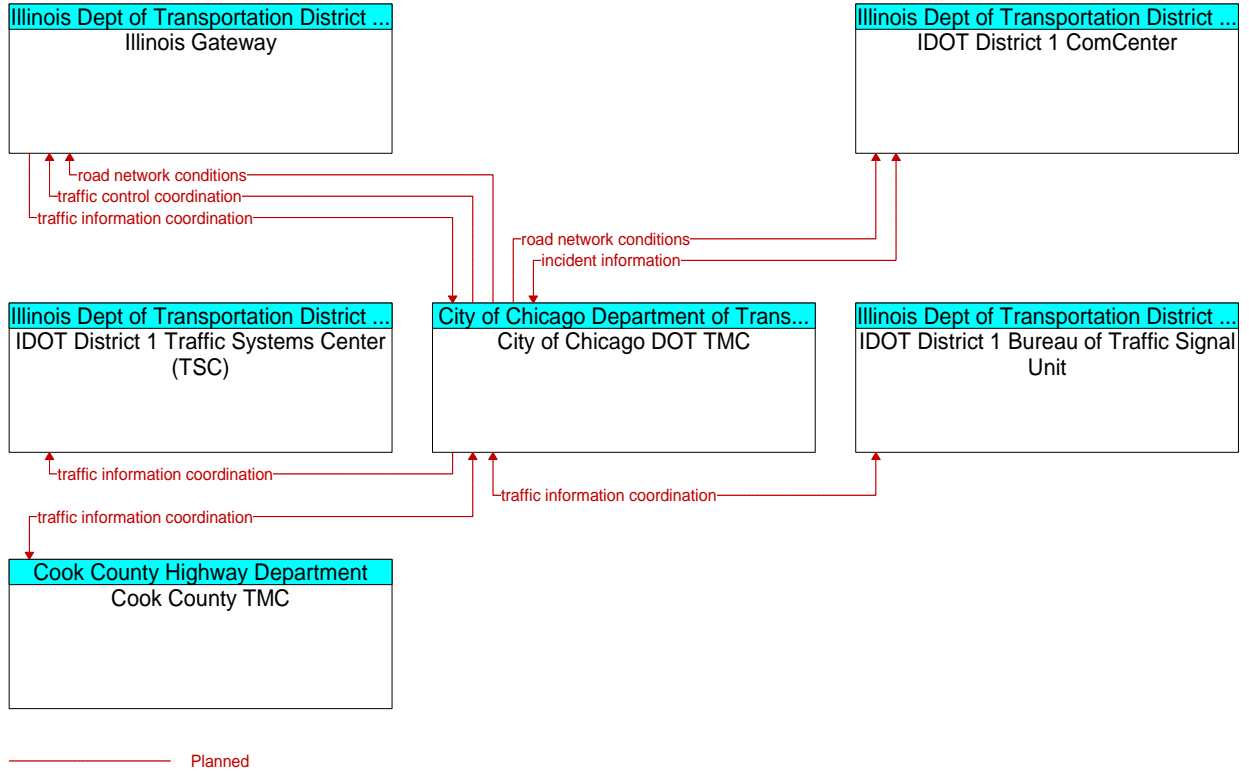
- City of Chicago DOT TMC
- City of Chicago DOT Roadside Equipment
- City of Chicago 911 Emergency Communications Center

CDOT currently has an operational “mini-TMC” with the Traffic Control Room at 30 N. LaSalle. It will be expanded in 2005 and will serve as the TMC until the permanent location is established.

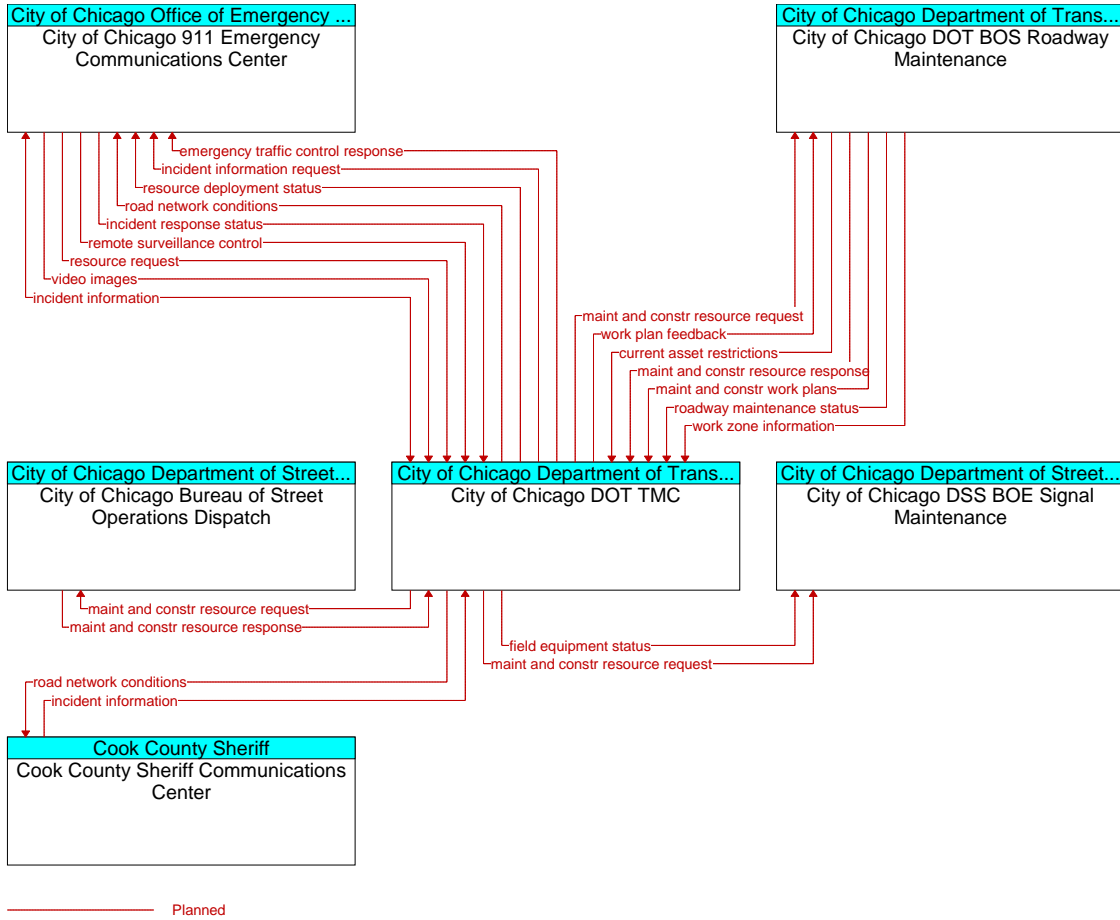
The interface and information flows from the TMC to roadside equipment (to perform network surveillance, incident detection, and surface street control and traffic information dissemination) from the Regional ITS Architecture that are covered by this project are shown in Figure A3-1. The interface and information flows from the TMC to other traffic management elements (to perform incident management and regional traffic control) from the Regional ITS Architecture are shown in Figure A3-2. The interfaces and information flows from the TMC to emergency or maintenance elements in the Regional ITS Architecture are shown in Figure A3-3.



**Figure A3-1: Development of Chicago TMC (ID 2)- Roadside Interface**



**Figure A3-2: Development of Chicago TMC (ID 2)- Traffic Management Interfaces**



**Figure A3-3: Development of Chicago TMC (ID 2)- Emergency and Maintenance Interfaces**

### A3-1.2 O’Hare Airport Satellite TMC (ID 3)

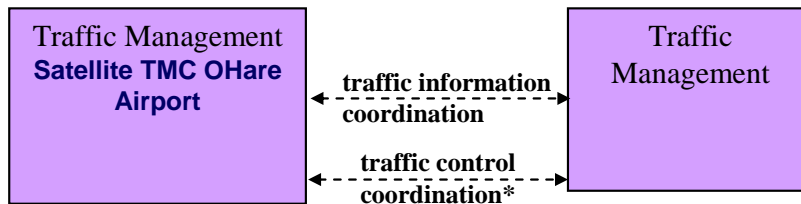
This project implements additional vehicle monitoring equipment around the airport and provides improved integration with other TMCS. The ITS Market Packages involved in the project are:

- Network Surveillance (ATMS01)
- Surface Street Control (ATMS03)
- Traffic Information Dissemination (ATMS06)
- Regional Traffic Control (ATMS07)
- Incident Management (ATMS08)

The elements from the Regional ITS Architecture involved in this project are:

- Satellite TMC O’Hare Airport
- City of Chicago Department of Aviation Roadside Devices (this element is not currently in the Regional ITS Architecture, but would be needed to describe the aspect of the project relating to vehicle monitoring.)
- Illinois Gateway
- City of Chicago DOT TMC
- Cook County TMC
- DuPage County TMC
- IDOT District 1 Bureau of Traffic Signal Unit
- IDOT District 1 ComCenter
- IDOT District 1 Traffic Systems Center (TSC)
- ISTHA TMC (TIMS)

The interfaces and information flows to other traffic management centers from the Regional ITS Architecture that are covered by this project are shown in Figure A3-4.



Traffic Management Center	traffic info coord	traffic control coord
City of Chicago DOT TMC	√	√
Cook County TMC	√	√
DuPage County TMC	√	√
IDOT District 1 Bureau of Traffic Signal Unit	√	
IDOT District 1 ComCenter	√	√
IDOT District 1 Traffic Systems Center (TSC)	√	√
Illinois Gateway	√	√
ISTHA TMC (TIMS)	√	

**Figure A3- 4: O’Hare Airport Satellite TMC (ID 3) – Traffic Management Interfaces**

**A3-1.3 Cicero Ave Smart Corridor ATMS Project (ID 4)**

This project has been underway for some time with currently deployed systems including 19 signals, 7 CCTVs, 2 DMSs and system detectors. It also includes the development of a Midway Airport Satellite Traffic Management Center. Future enhancements relate to traffic adaptive control on the signals and possibly other roadside device enhancements.

The ITS Market Packages involved in the project are:

- Network Surveillance (ATMS01)
- Surface Street Control (ATMS03)
- Traffic Information Dissemination (ATMS06)
- Regional Traffic Control (ATMS07)
- Incident Management (ATMS08)

The elements from the Regional ITS Architecture involved in this project are:

- City of Chicago DOT TMC
- City of Chicago DOT Roadside Equipment
- City of Chicago 911 Emergency Communications Center
- IDOT District 1 Bureau of Traffic Signal Unit
- Satellite TMC Midway Airport

The interfaces and information flows from the Regional ITS Architecture that are covered by this project are shown in Figure A3-5.

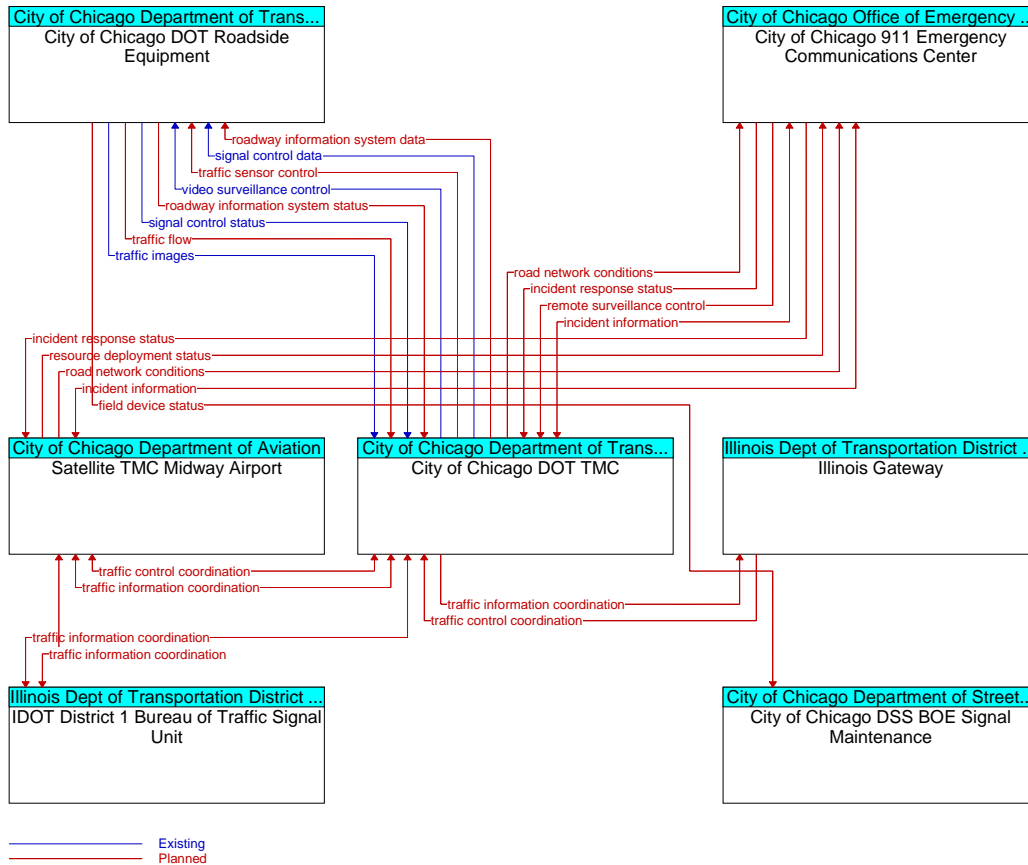


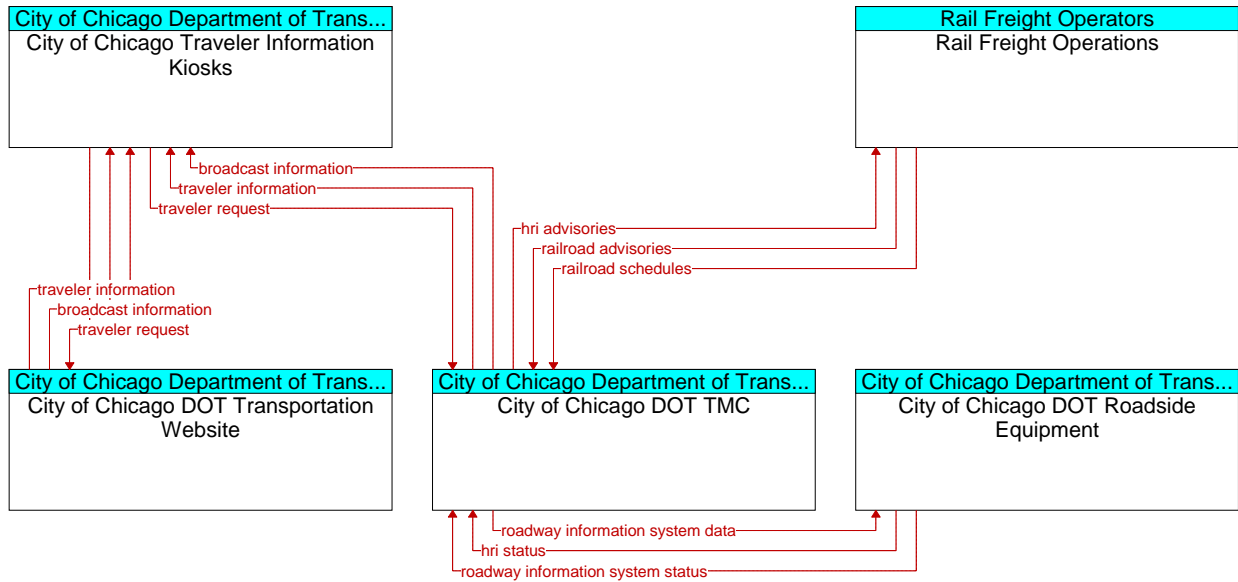
Figure A3- 5: Cicero Ave Smart Corridor ATMS Project (ID 4)

### A3-1.4 Cicero Ave Smart Corridor ATIS(ID 5)

This project provides upgrades to several traveler information systems along the smart corridor. Specifically the project will develop HAR upgrades to provide information on closures of highway rail intersections, Enhanced Traveler Information Kiosks, and Dynamic Message Signs. The Market Packages covered by this project include Traffic Information Dissemination (ATMS06), Standard Rail Grade Crossing (ATMS13) and Interactive Traveler Information (ATIS2). The elements from the Regional ITS Architecture covered by this project are:

- City of Chicago DOT Roadside Equipment
- City of Chicago DOT TMC
- City of Chicago Traveler Information Kiosks (this element is not currently in the Regional ITS Architecture)

The interfaces and information flows from the Regional ITS Architecture that are covered by this project are shown in Figure A3-6.



Planned

**Figure A3-6: Cicero Ave Smart Corridor ATIS (ID 5)**

**A3-1.5 CDOT Smart Corridors: Pulaski Road, etc. (ID 6)**

This project involves multiple “smart corridors” which utilize arterial traffic management with fiber-interconnected signals, CCTVs vehicle detector stations and/or VMS. These smart corridors are selected based upon a priority model developed by CDOT. The exact capabilities implemented may vary by location, which will mean that some subset of the elements, and interfaces will actually be implemented. The Market Packages covered by this project will be a subset of the following:

- Network Surveillance (ATMS01)
- Surface Street Control (ATMS 03)
- Traffic Information Dissemination (ATMS06)
- Standard Rail Grade Crossing (ATMS 13) and
- Interactive Traveler Information (ATIS2)

The elements from the Regional ITS Architecture covered by this project are:

- City of Chicago DOT Roadside Equipment
- City of Chicago DOT TMC
- City of Chicago 911 Emergency Communications Center
- IDOT District 1 Bureau of Traffic Signal Unit

The interfaces and information flows from the Regional ITS Architecture that are covered by this project are shown in Figure A3-7. The architecture flows for environmental

conditions data are not in the current Regional ITS Architecture and will need to be added at the architecture update.

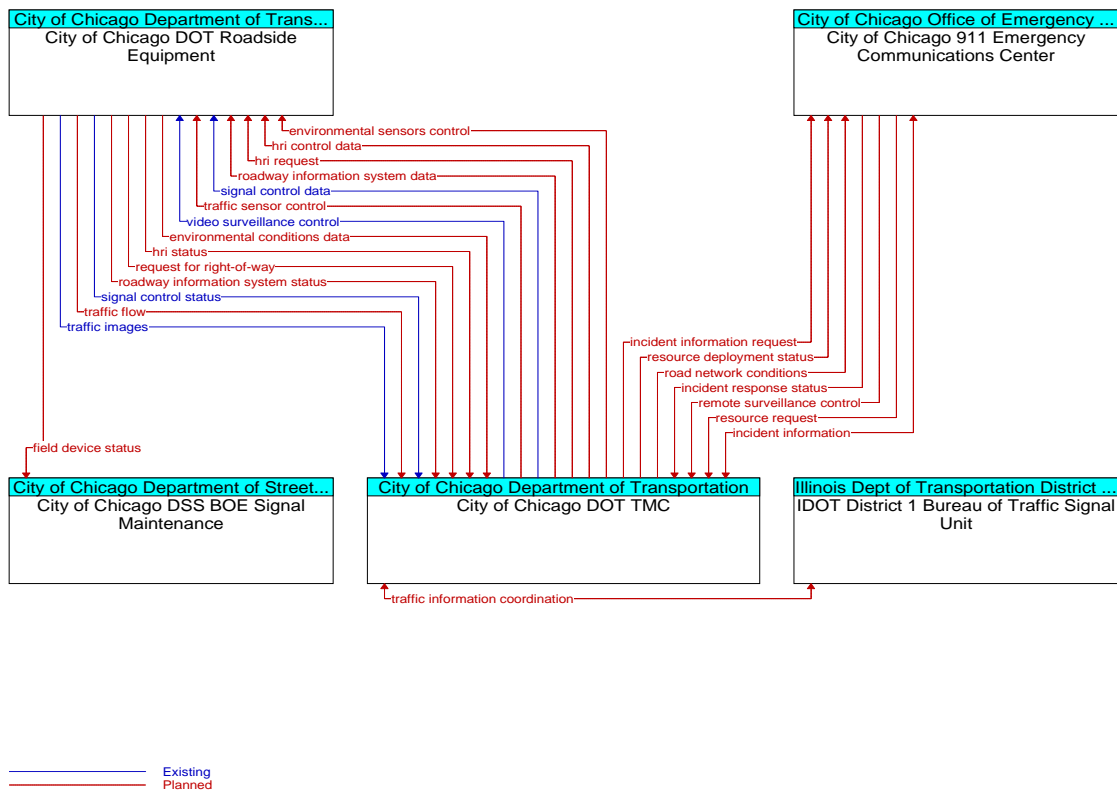


Figure A3- 7: CDOT Smart Corridors: Pulaski Road, etc. (ID 6)

### A3-1.6 Museum Campus Transportation System (Chicago) (ID 7)

This project deploys portable DMS and CCTV for parking and special events management including facilities from McCormick Place to Navy Pier. The Market Packages covered by this project are:

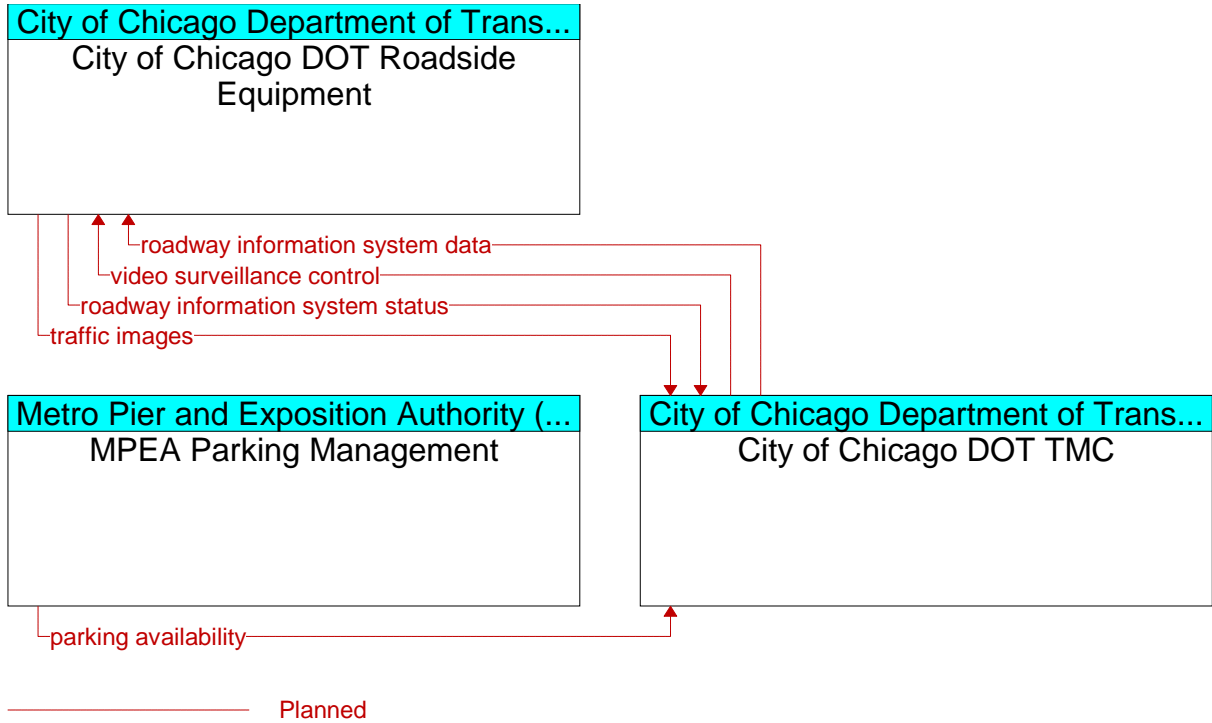
- Traffic Information Dissemination (ATMS06),
- Traffic Incident Management System (ATMS08), and
- Regional Parking Management (ATMS17).

The elements of the Regional ITS Architecture covered by this project are:

- City of Chicago DOT Roadside Equipment
- City of Chicago DOT TMC
- MPEA Parking Management

The interfaces and information flows from the Regional ITS Architecture that are covered by this project are shown in Figure A3-8.





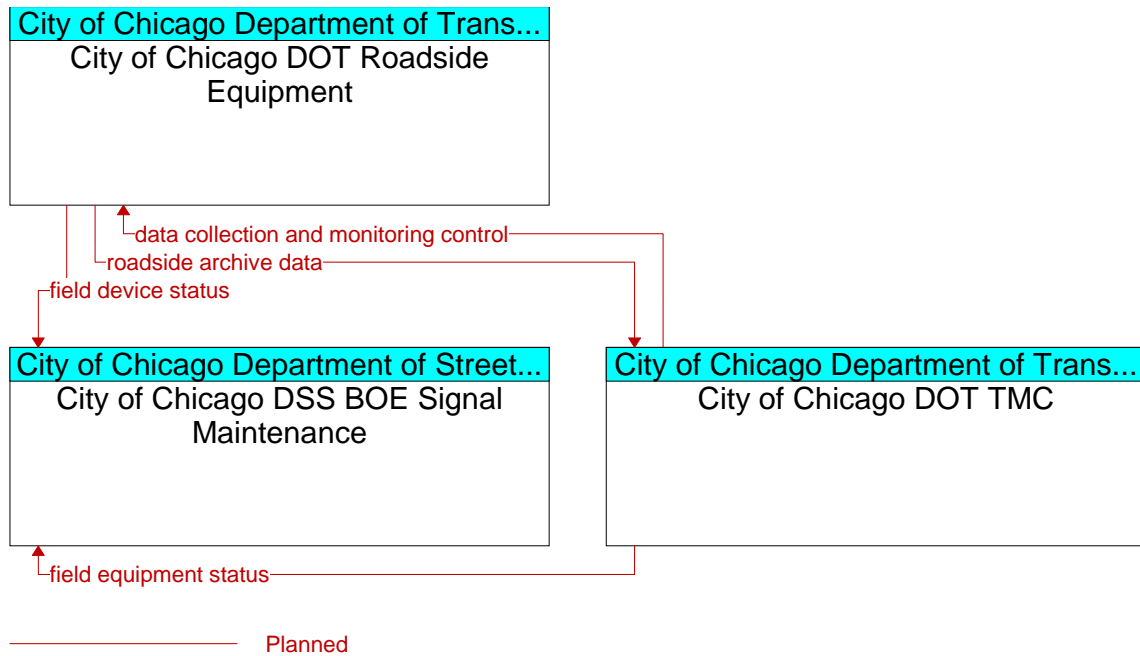
**Figure A3-8: Museum Campus Transportation System (Cook/Chicago) (ID 7)**

**A3-1.7 Chicago HTMS (ID 8)**

The Chicago Highway Traffic Monitoring System (HTMS) project would add traffic counting stations at 30-33 locations throughout the city. The traffic counts could then be used for transportation planning and other non-operational means. The Market Package covered is ITS Data Mart (AD1). The elements from the Regional ITS Architecture covered by this project are:

- City of Chicago DOT Roadside Equipment
- City of Chicago DOT TMC
- City of Chicago DSS BOE Signal Maintenance

The interfaces and information flows from the Regional ITS Architecture that are covered by this project are shown in Figure A3-9. Note the interface between the Roadside Equipment and the TMC (including roadside archive data) is not in the current Regional ITS Architecture and will need to be added. The current Regional ITS Architecture has an operational data interface between these two elements, but not an archiving interface (which is appropriate for traffic count collection).



**Figure A3-9: Chicago HTMS (ID 8)**

**A3-1.8 CDOT Field Devices (ID 10)**

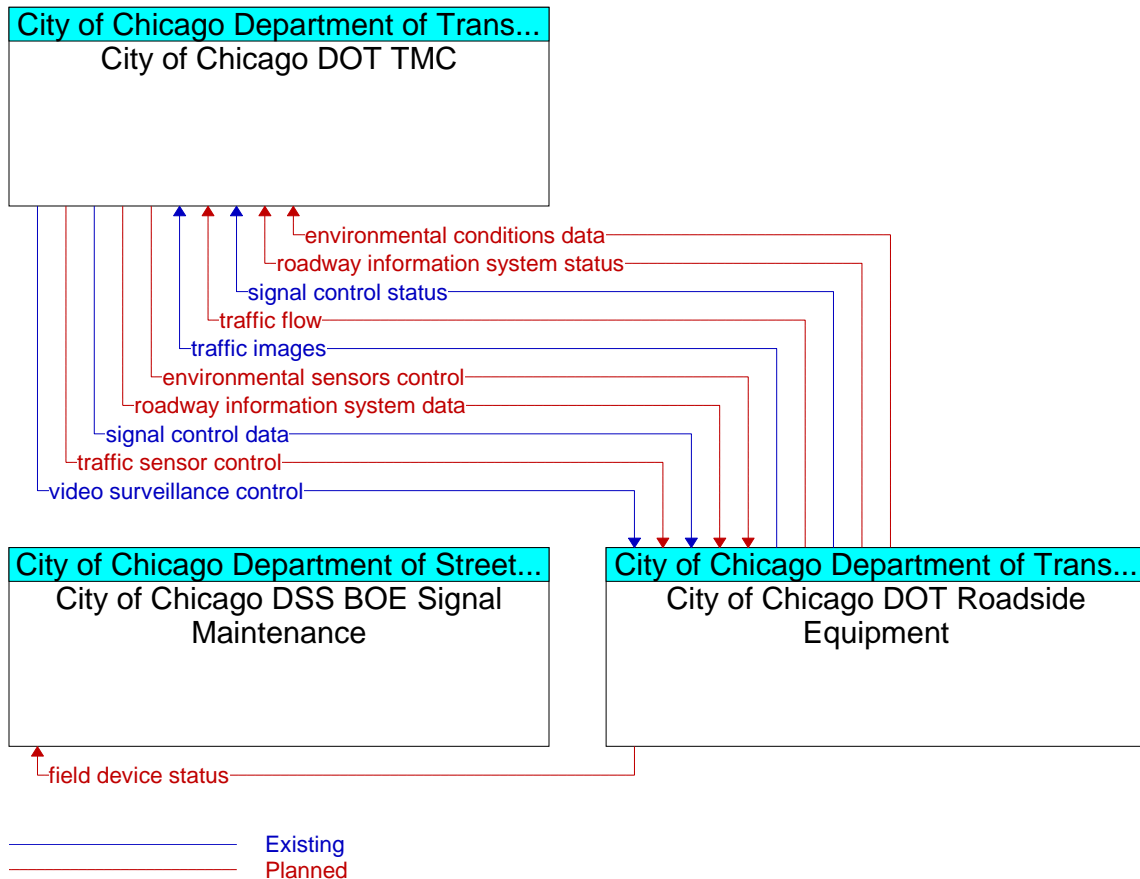
This project covers upgrades to CDOT field equipment such as Traffic monitoring, CCTV, DMS and signal interconnects identified in Smart Corridors Project. Environmental sensors RWIS are included in the architecture. The Market Packages covered by this project are:

- Network Surveillance (ATMS01),
- Surface Street Control (ATMS03),
- Traffic Incident Management System (ATMS08), and
- Road Weather Data Collection (MC03).

The elements of the Regional ITS Architecture covered by this project are:

- City of Chicago DOT Roadside Equipment
- City of Chicago DOT TMC
- City of Chicago DOT BOS Roadway Maintenance

The interfaces and information flows from the Regional ITS Architecture that are covered by this project are shown in Figure A3-10. The environmental conditions data information flow is not in the current Regional ITS Architecture and will need to be added to the architecture.



**Figure A3-10: CDOT Field Devices (ID 10)**

**A3-1.9 City of Chicago Interconnects (ID 11)**

This project provides coordination of signals on city of Chicago arterials. The project may include signal timing across municipal and county boundaries. The Market Packages provided by this project are:

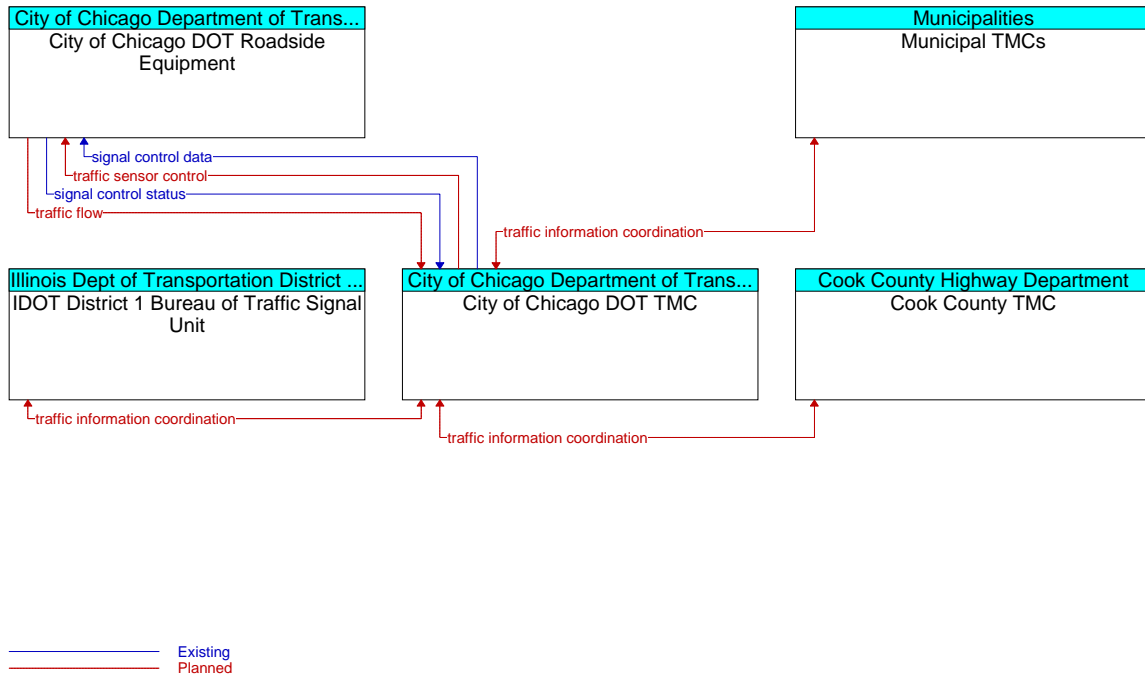
- Surface Street Control (ATMS03) and
- Regional Traffic Control (ATMS07).

The elements from the Regional ITS Architecture covered by this project are:

- City of Chicago DOT TMC

- City of Chicago DOT Roadside Equipment
- Cook County TMC
- IDOT District 1 Bureau of Traffic Signal Unit
- Municipal TMCs

The interfaces and information flows from the Regional ITS Architecture that are covered by this project are shown in Figure A3-11. The interface with the Municipal TMCs is not in the current Regional ITS Architecture and would need to be added.



**Figure A3-11: City of Chicago Interconnects**

**A3-1.10 CDOT Fleet AVL (ID 12)**

This project covers the implementation of an automated vehicle location (AVL) system (e.g. GPS) for asphalt paving trucks and snow plows. The Market Package covered by this project is Maintenance and Construction Vehicle and Equipment Tracking (MC01). The elements of the Regional ITS Architecture covered by this project are:

- City of Chicago Bureau of Street Operations Dispatch (department that operates snow plows)
- City of Chicago Bureau of Street Operations Vehicles (this element is not in the Regional ITS Architecture and would need to be added)
- City of Chicago DOT BOS Roadway Maintenance (department that operates the road paving trucks)
- City of Chicago DOT BOS Vehicles (this element is not in the Regional ITS Architecture and would need to be added)

The interfaces and information flows from the Regional ITS Architecture that are covered by this project are shown in Figure A3-12. The interfaces with the maintenance vehicles are not in the current Regional ITS Architecture and will need to be added to the architecture.

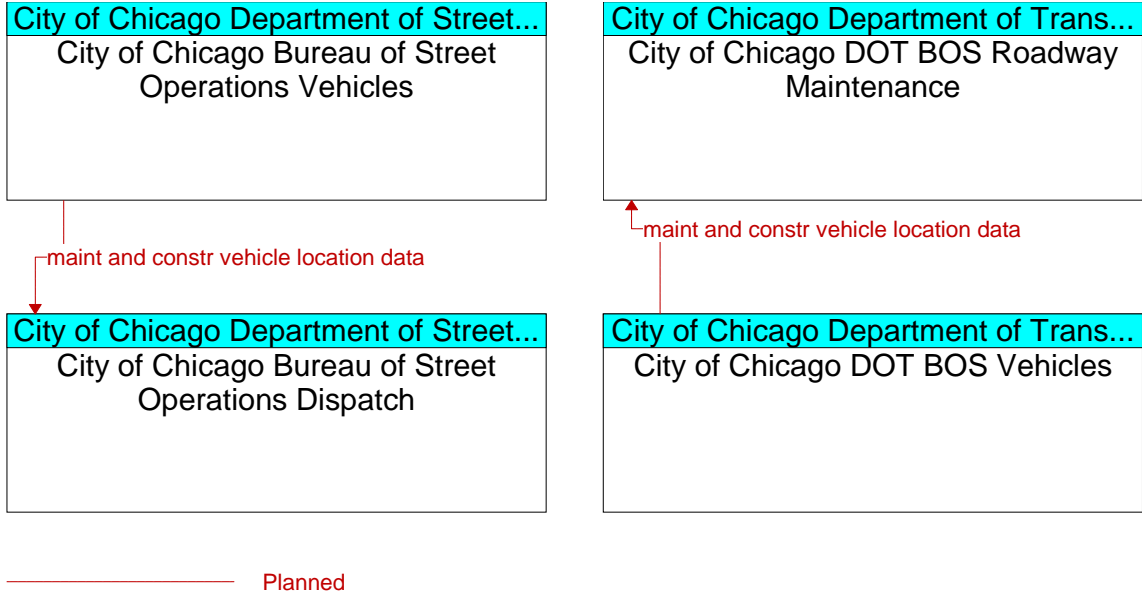


Figure A3-12: CDOT Fleet AVL (ID 12)

### A3-1.11 Chicago Skyway Travel Monitoring and Integration with IDOT Gateway (ID 13)

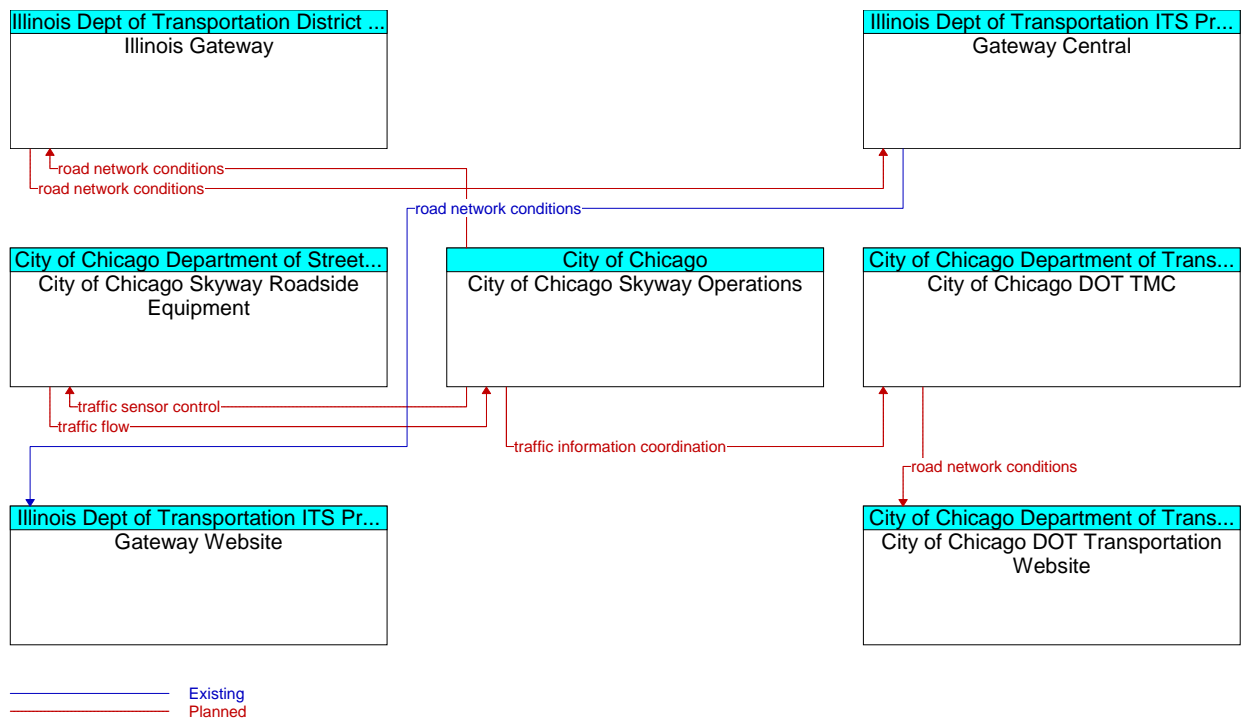
This project provides network surveillance on the Chicago Skyway by placing RTMS devices at 1/2 mile intervals along the Skyway. The information would be used to generate real-time travel time data that would be sent to the Chicago TMC and integrated in the IDOT/GCM regional expressway/tollway travel time maps. While this project is currently listed in the CDOT section, the Skyway has recently been leased by Chicago to a private consortium who will operate it beginning in 2005. The Market Packages covered by this project are

- Network Surveillance (ATMS01) and
- Broadcast Traveler Information (ATIS1).

The elements from the Regional ITS Architecture covered by this project are:

- City of Chicago Skyway Roadside Equipment
- City of Chicago Skyway Operations
- City of Chicago DOT TMC
- City of Chicago DOT Transportation Website
- Illinois Gateway
- Gateway Central
- Gateway Website

The interfaces and information flows from the Regional ITS Architecture that are covered by this project are shown in Figure A3-13.



**Figure A3-13: Chicago Skyway Travel Monitoring and Integration with IDOT Gateway (ID 13)**

**A3-1.12 US 41 Lake Shore Drive Surveillance and Information System (ID 14)**

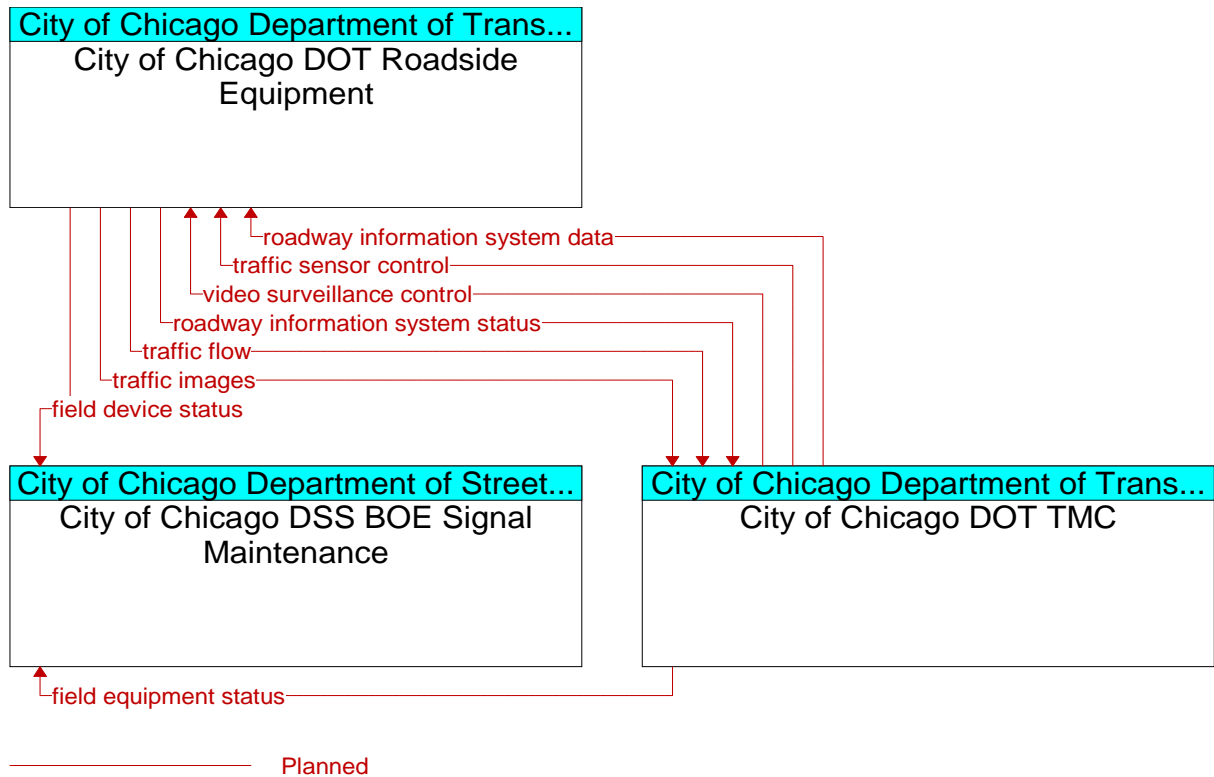
This project provides Dynamic Message signs (which may be portable) and traffic monitoring equipment along US 41 Lake Shore Drive from Hollywood Ave (Cook/Chicago) to 57th St (Cook/Chicago). The Market Packages provided are

- Network Surveillance (ATMS01) and
- Traffic Information Dissemination (ATMS06).

The elements from the Regional ITS Architecture covered by this project are:

- City of Chicago DOT Roadside Equipment
- City of Chicago DOT TMC
- City of Chicago DSS BOE Signal Maintenance

The interfaces and information flows from the Regional ITS Architecture that are covered by this project are shown in Figure A3-14.



**Figure A3-14: US 41 Lake Shore Drive information system (ID 14)**

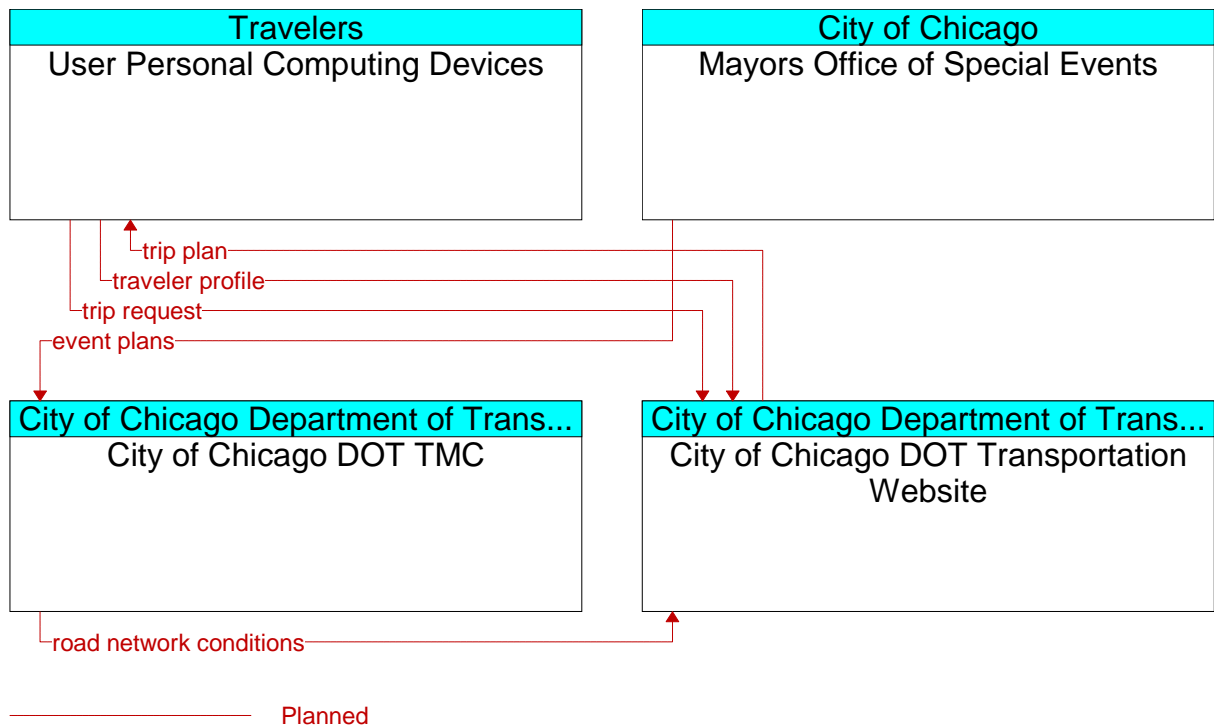
**A3-1.13 Chicago Truck Route Advisory System (ID 15)**

This project will provide an interactive web page in which truckers would enter an origin and destination plus characteristics of their truck (height, weight, length), and the web site would provide them with information regarding viaduct clearances, construction, truck route restrictions, weight limits and special permits where needed (e.g., Lake Shore Dr.). Eventually, more dynamic aspects such as street closures and special events would be added.

The Market Package provided is Route Guidance (ATIS6). The elements from the Regional ITS Architecture covered by this project are:

- City of Chicago DOT Transportation Website
- City of Chicago DOT TMC
- Mayors Office of Special Events

The interfaces and information flows from the Regional ITS Architecture that are covered by this project are shown in Figure A3-15. This view of the project implies the database (of commercial vehicle route restriction information) is a part of the element City of Chicago DOT Transportation Website. In fact the database would probably reside at the City of Chicago DOT TMC, or some other element not currently defined. If this is the case, then the Regional ITS Architecture should be updated to better reflect the connectivity of this project.



**Figure A3-15: Chicago Truck Route Advisory System (ID 15)**

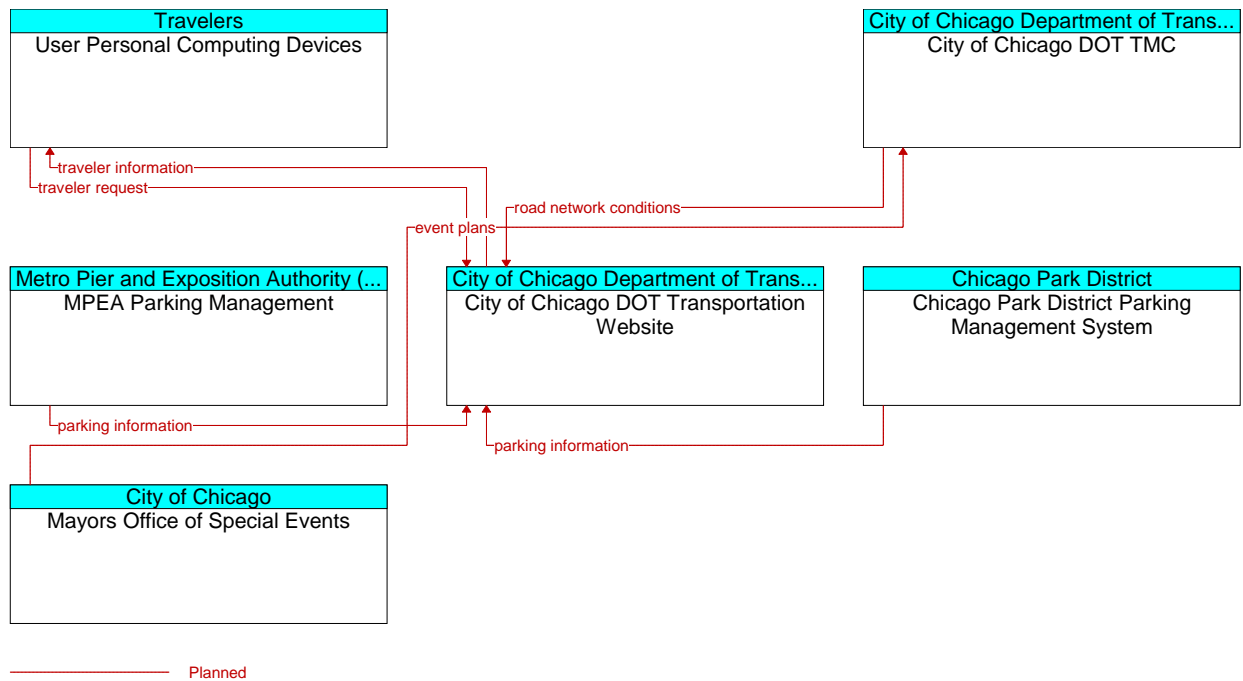


### A3-1.14 Chicago Special Event Advisory System (ID 16)

This project would provide web site information for travelers relating to current route restrictions, special events, construction, etc. This System might be integrated into the Truck Route Advisory System with added shuttle and parking information. The Market Package provided is Interactive Traveler Information (ATIS2). The elements from the Regional ITS Architecture covered by this project are:

- City of Chicago DOT Transportation Website
- City of Chicago DOT TMC
- Mayors Office of Special Events
- Chicago Park District Parking Management System
- MPEA Parking Management

The interfaces and information flows from the Regional ITS Architecture that are covered by this project are shown in Figure A3-16. This view of the project implies the database (of events, parking info, etc.) is a part of the element “City of Chicago DOT Transportation Website”. In fact the database and would probably reside at the City of Chicago DOT TMC, or some other element not currently defined. If this is the case, then the Regional ITS Architecture should be updated to better reflect the connectivity of this project.



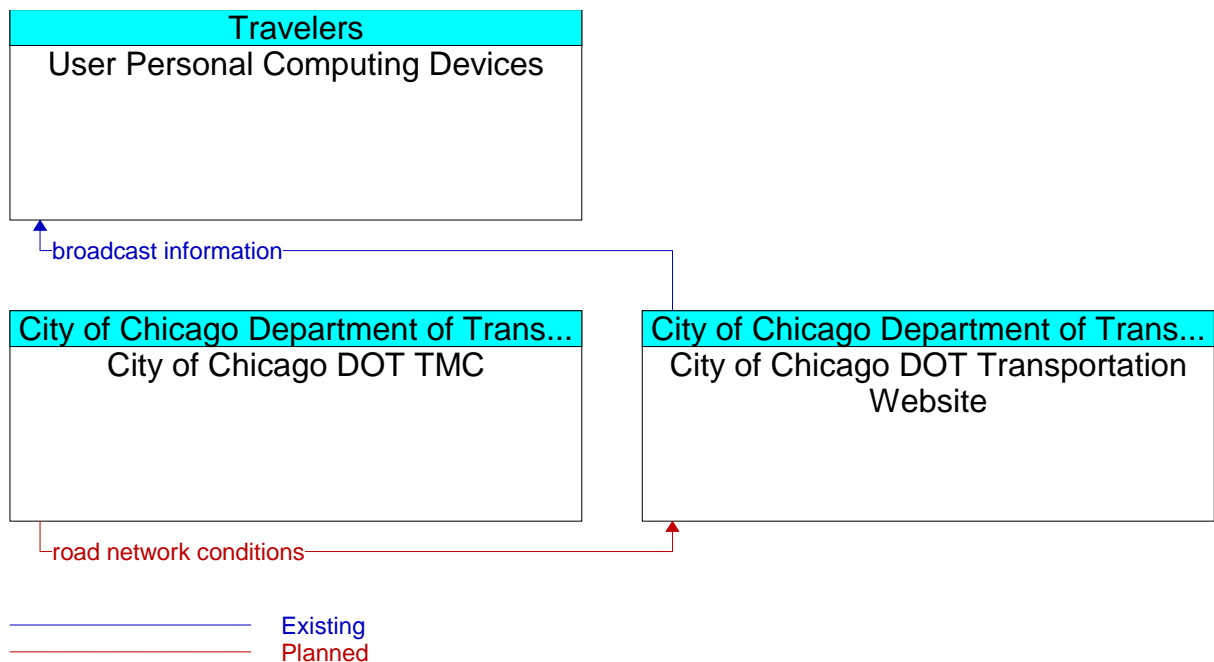
**Figure A3-16: Chicago Special Event Advisory System (ID 16)**

**A3-1.15 Chicago Arterial Congestion Advisory System (ID 17)**

This project will provide real-time congestion and travel time information on the surface street system via City of Chicago web site. The Market Package provided is Broadcast Traveler Information (ATIS1). This project focuses on providing the travel time information to the public. The elements from the Regional ITS Architecture covered by this project are:

- City of Chicago DOT Transportation Website
- City of Chicago DOT TMC

The interfaces and information flows from the Regional ITS Architecture that are covered by this project are shown in Figure A3-17.



**Figure A3-17: Chicago Arterial Congestion Advisory System (ID 17)**

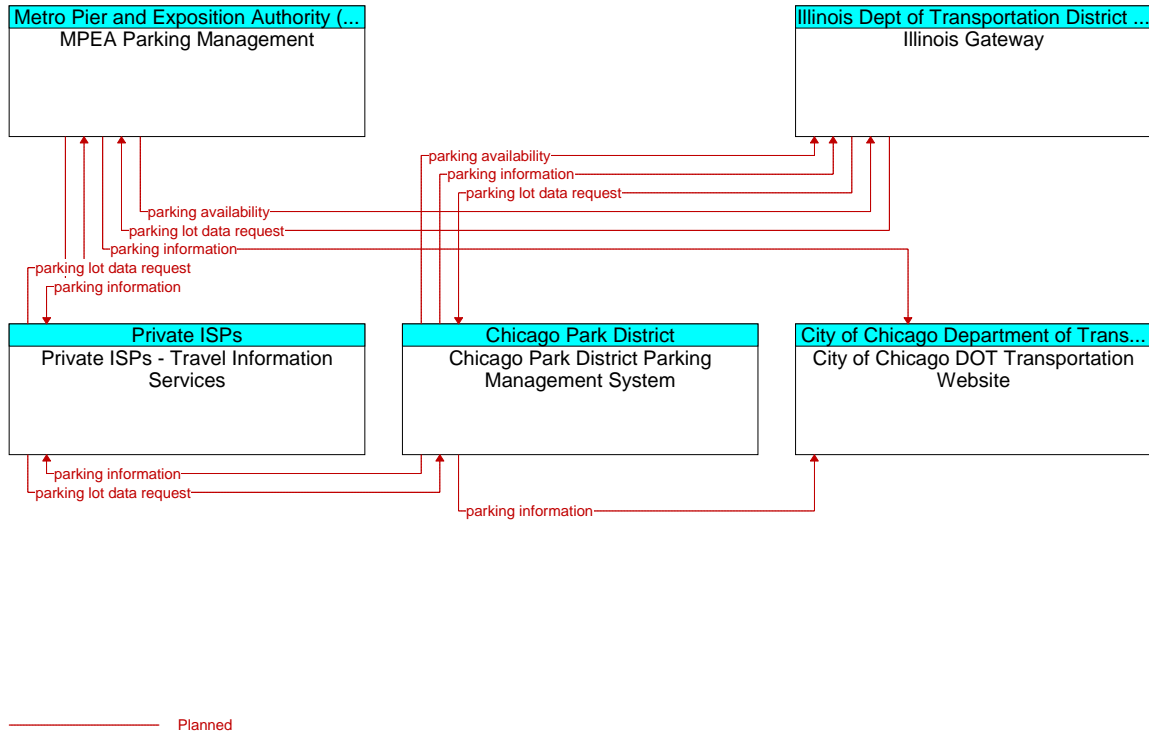
**A3-1.16 Parking Information Projects (ID 18)**

This project will provide real-time parking and traveler information for Navy-pier and Grant Park/ Millennium Park. The Market Package provided is Parking Facility Management (ATMS16). This project focuses on providing the real time parking information to the public. The elements from the Regional ITS Architecture covered by this project are:

- Chicago Park District Parking Management System (manages Millennium Park parking)
- MPEA Parking Management (manages Navy Pier parking)
- City of Chicago DOT Transportation Website

- Illinois Gateway and
- Private ISPs- Travel Information Services

The interfaces and information flows from the Regional ITS Architecture that are covered by this project are shown in Figure A3-18.



**Figure A3-18: Parking Information Projects (ID 18)**

### **A3-1.17 Additional CDOT Projects**

Two CDOT projects can not really be mapped to the Regional ITS Architecture. The projects are listed below along with the reason for not assigning a mapping:

- CDOT Data Pipeline (ID 1): This project relates to the communications infrastructure that supports connectivity in the architecture, but does not encompass specific connections between elements of the architecture.
- CDOT Red-Light Camera Enforcement Program (ID 9): This project will deploy red-light running cameras with automated process to ticket violators at approximately 5 percent (100-200) of the traffic signals in the city. The city is also considering using automated enforcement for speeding, railroad gate running, at grade crossing enforcement, and truck weight enforcement. The following Market Packages (which are not currently covered in the Regional ITS Architecture and would need to be added) would apply to this project:
  - Traffic Signal Enforcement (for red light running and railroad gate running- this market package would be a local service, not one of the National ITS Architecture Market Packages).
  - Speed Monitoring (for automated speed enforcement)
  - Weigh-in-Motion (for truck weight enforcement)

### A3-2 Cook County Projects

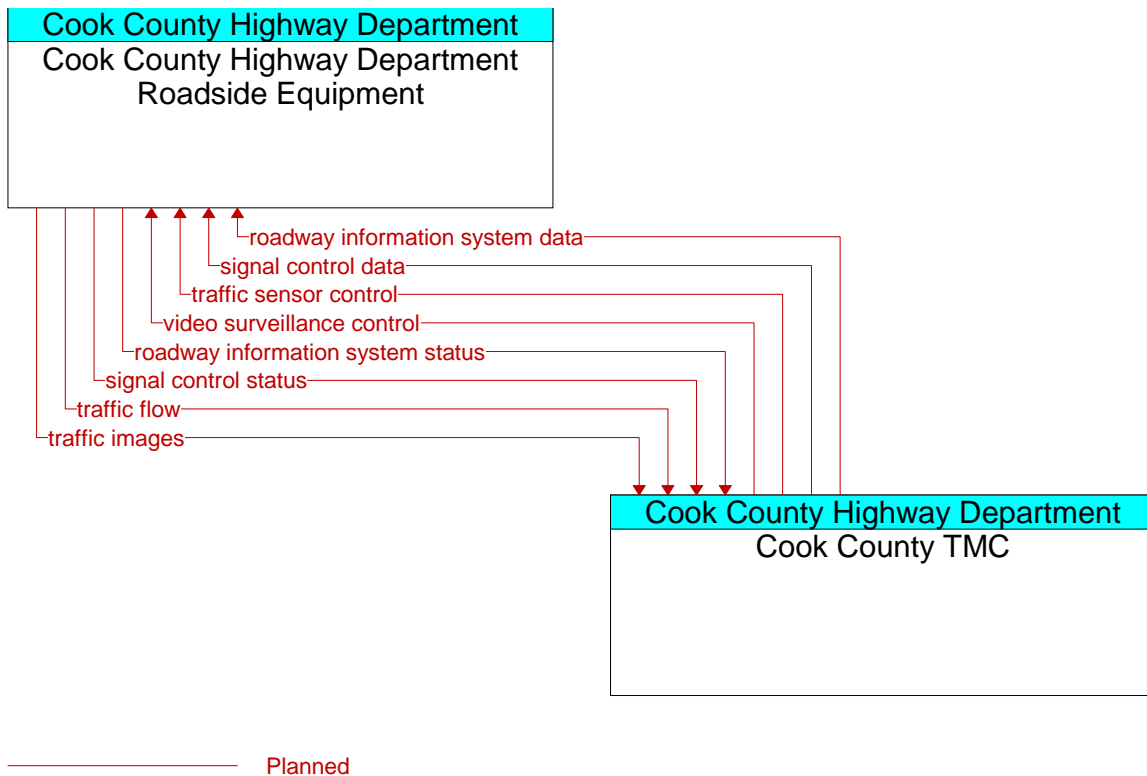
#### A3-2.1 Cook County Traffic Management Center (ID 19)

This project would develop a Cook County TMC capability. The center may be located in Schaumburg, initially covering northern Cook County. Alternatively the center capability could be collocated with CDOT or IDOT TMC rather than a stand alone facility. The Market Packages covered by this project include Network Surveillance (ATMS01), Surface Street Control (ATMS03), Traffic Information Dissemination (ATMS06), Regional Traffic Control (ATMS07), and Traffic Incident Management System (ATMS08).

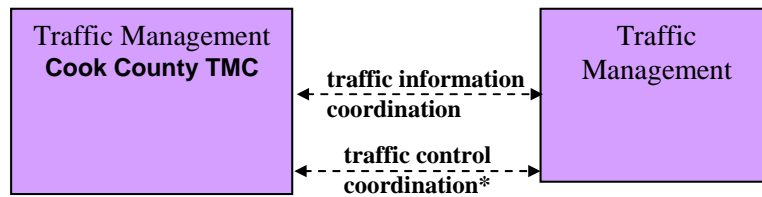
The elements from the Regional ITS Architecture covered by this project are:

- Cook County TMC
- Cook County Highway Department Roadside Equipment
- Other Regional Traffic Management Elements (see figure below)
- Regional Emergency Management Elements (see figure below)

The interfaces and information flows from the Regional ITS Architecture that are covered by this project are shown in Figure A3-19 through Figure A3-21.

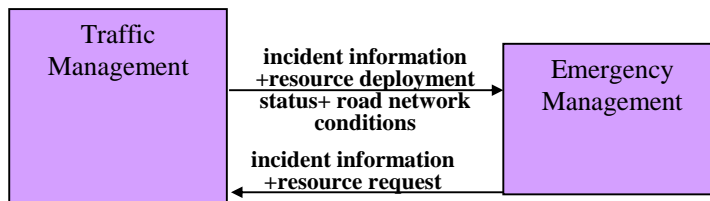


**Figure A3-19: Cook County TMC- Roadside Equipment Interfaces**



Traffic Management Center	traffic info coord	traffic control coord
City of Chicago DOT TMC	√	
DuPage County TMC	√	
IDOT District 1 Bureau of Traffic Signal Unit	√	
IDOT District 1 ComCenter	√	
IDOT District 1 Traffic Systems Center (TSC)	√	
Illinois Gateway	√	√
ISTHA TMC (TIMS)	√	
Kane County TMC	√	√
Lake County TMC	√	√
Satellite TMC Midway Airport	√	√
Satellite TMC OHare Airport	√	√
Will County TMC	√	

Figure A3-20: Cook County TMC- Traffic Management Interfaces



Traffic Management Center	Emergency Management Centers
Cook County TMC	<ul style="list-style-type: none"> <li>•City of Chicago 911 Emergency Comm Center</li> <li>•Cook County Sheriff Communications Center</li> <li>•DuPage County Sheriffs Communications Center</li> <li>•IDOT District 1 ComCenter</li> <li>•Kane County 911 Center</li> <li>•Lake County Comm Center</li> </ul>

Figure A3-21: Cook County TMC- Emergency Management Interfaces

**A3-2.2 Cook County Lake- Cook Travel Demonstration (ID 20)**

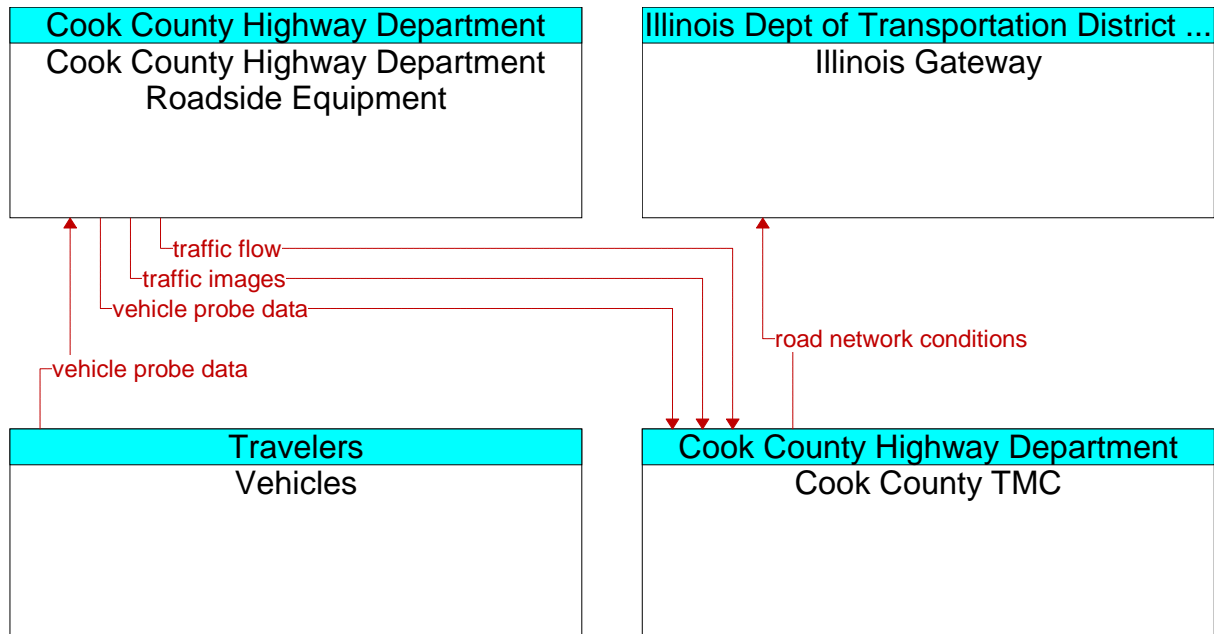
This project is developing (in coordination with Northwestern University) a demonstration of arterial traffic monitoring, arterial incident management and enhanced traveler information. One idea under consideration is using I-Pass transponders for the arterial monitoring. The Market Packages covered by this project are

- Network Surveillance (ATMS01),
- Probe Surveillance (ATMS02),
- Traffic Incident Management System (ATMS08), and
- Broadcast Traveler Information (ATIS1).

The elements from the Regional ITS Architecture covered by this project are:

- Cook County TMC
- Cook County Highway Department Roadside Equipment
- Illinois Gateway
- Vehicles

The interfaces and information flows from the Regional ITS Architecture that are covered by this project are shown in Figure A3-22. The “vehicle probe data” flows are not in the current Regional ITS Architecture and would need to be added.



————— Planned

**Figure A3-22: Cook County Lake- Cook Travel Demonstration Project (ID 20)**

**A3-2.3 Cook County Field Devices (ID 21)**

This project includes Opticom Installation (for emergency vehicle signal preemption) for West Central Com, which will cover Ogden Ave from Wolf Rd (Cook/Western Springs) to Central Ave (Cook/Western Springs). The project also covers implementation of video image detection for arterials, arterial DMS and arterial performance monitoring

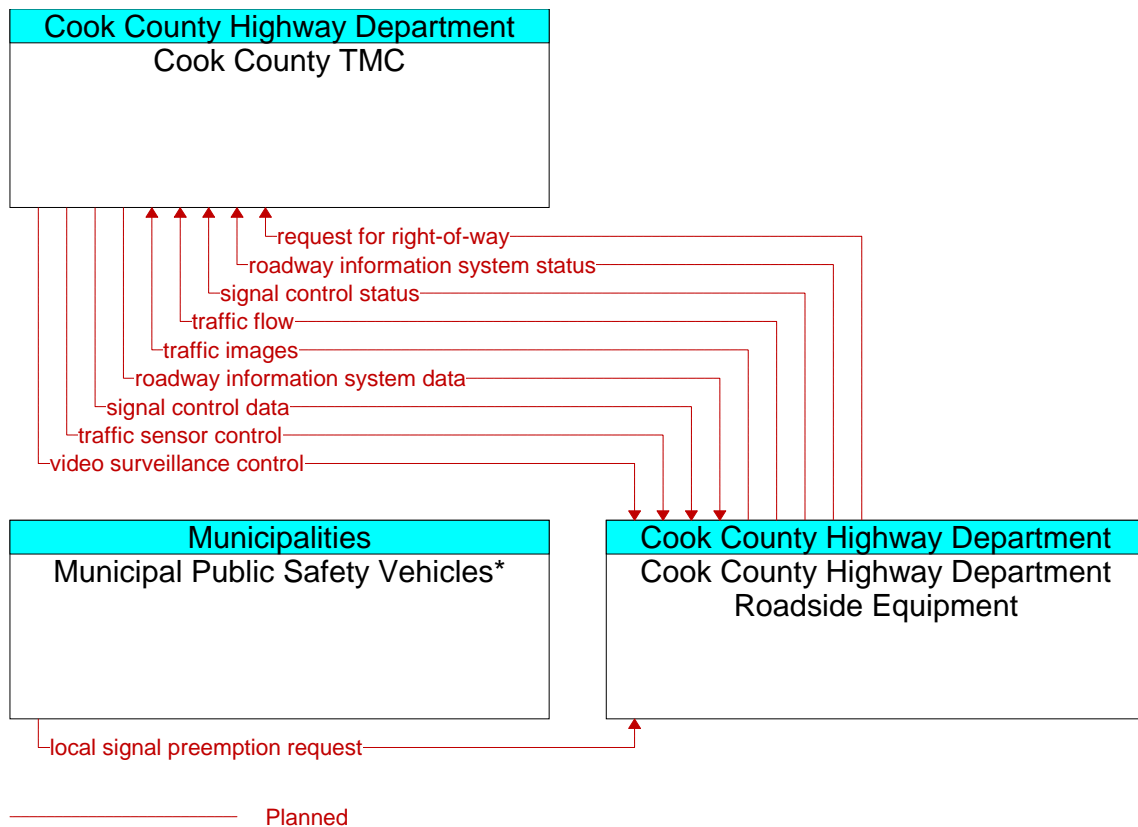
The Market Packages covered by this project are:

- Network Surveillance (ATMS01)
- Traffic Information Dissemination (ATMS06) and
- Emergency Routing (EM02).

The elements from the Regional ITS Architecture covered by this project are:

- Cook County TMC
- Cook County Highway Department Roadside Equipment
- Municipal Public Safety Vehicles (this element does not currently exist in the Regional ITS Architecture)

The interfaces and information flows from the Regional ITS Architecture that are covered by this project are shown in A3-23.



**Figure A3-23: Cook County Field Devices (ID 21)**

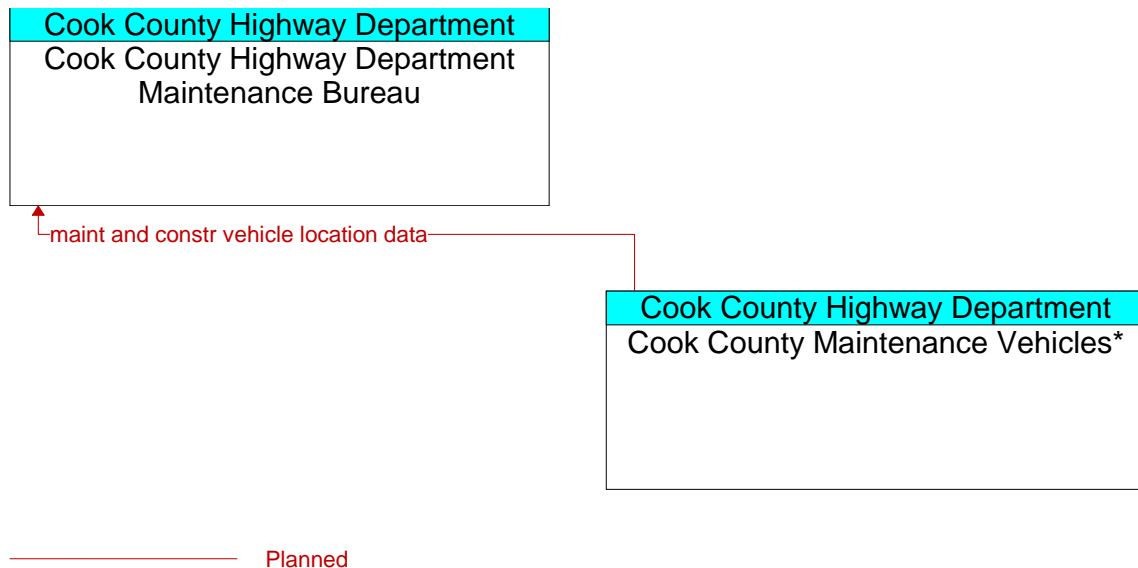


**A3-2.4 Cook County Fleet AVL (ID 22)**

This project covers the implementation of an automated vehicle location (AVL) system (e.g. GPS) for asphalt paving trucks and snow plows operated by Cook County. The Market Package covered by this project is Maintenance and Construction Vehicle and Equipment Tracking (MC01). The elements of the Regional ITS Architecture covered by this project are:

- Cook County Highway Department Maintenance Bureau
- Cook County Maintenance Vehicles (this element is not in the Regional ITS Architecture and would need to be added)

The interfaces and information flows from the Regional ITS Architecture that are covered by this project are shown in Figure A3-24. The interfaces with the maintenance vehicles are not in the current Regional ITS Architecture and will need to be added to the architecture.



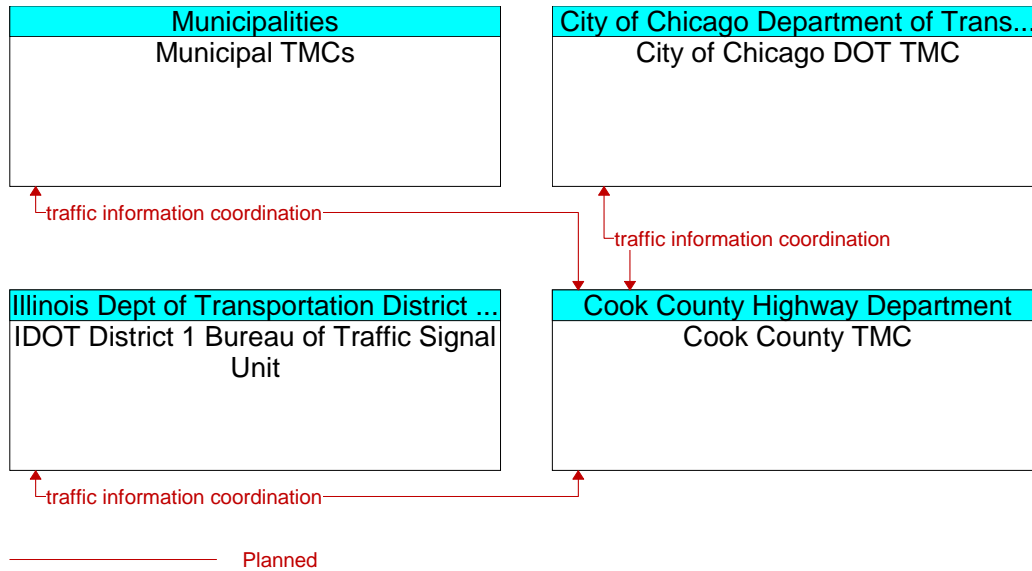
**Figure A3-24: Cook County Fleet AVL (ID 22)**

**A3-2.5 Cook County Signal Interconnects (ID 23)**

This project provides coordination between signal systems operated by Cook County and those of adjacent jurisdictions. The Market Package provided by this project is Regional Traffic Control (ATMS07). The elements from the Regional ITS Architecture covered by this project are:

- Cook County TMC
- City of Chicago DOT TMC
- IDOT District 1 Bureau of Traffic Signal Unit
- Municipal TMCs

The interfaces and information flows from the Regional ITS Architecture that are covered by this project are shown in Figure A3-25.



**Figure A3-25: Interagency Signal Coordination- Cook County (ID 23)**

### **A3-3 DuPage County Projects**

#### **A3-3.1 DuPage County Transportation Coordination Initiative (TCI) (ID 24)**

This project is not well defined at present, but some of the services being considered are incident management, regional traffic control, traffic information dissemination and broadcast traveler information. The project may include some kind of traffic management facility, but this is one of the aspects of the project that is not yet defined. The project will begin with a feasibility study to define the scope of the effort.

The project will likely cover some or all of the following market packages:

- Network Surveillance (ATMS01)
- Surface Street Control (ATMS03)
- Traffic Information Dissemination (ATMS06)
- Regional Traffic Control (ATMS07)
- Traffic Incident Management (ATMS08)
- Broadcast Traveler Information (ATIS1)
- Transit Multimodal Coordination (APTS7)

From a Regional ITS Architecture viewpoint the following elements may be involved in the project:

- DuPage County TMC (The Regional ITS Architecture has both this element and a DuPage Area TMC. The name and scope of the traffic management element will need to be revised when the feasibility study defines the name and scope of this element)
- DuPage County Roadside Equipment
- DuPage County Maintenance

- DuPage County Sheriff Comm Center
- Municipal TMCs (representing traffic operations at municipalities such as Naperville)
- Illinois Gateway

Depending on the scope of this project the Regional ITS Architecture will need to be modified to fully cover the elements that relate to this project.

### **A3-3.2 DuPage Emergency Management and Signal Preemption (ID 25)**

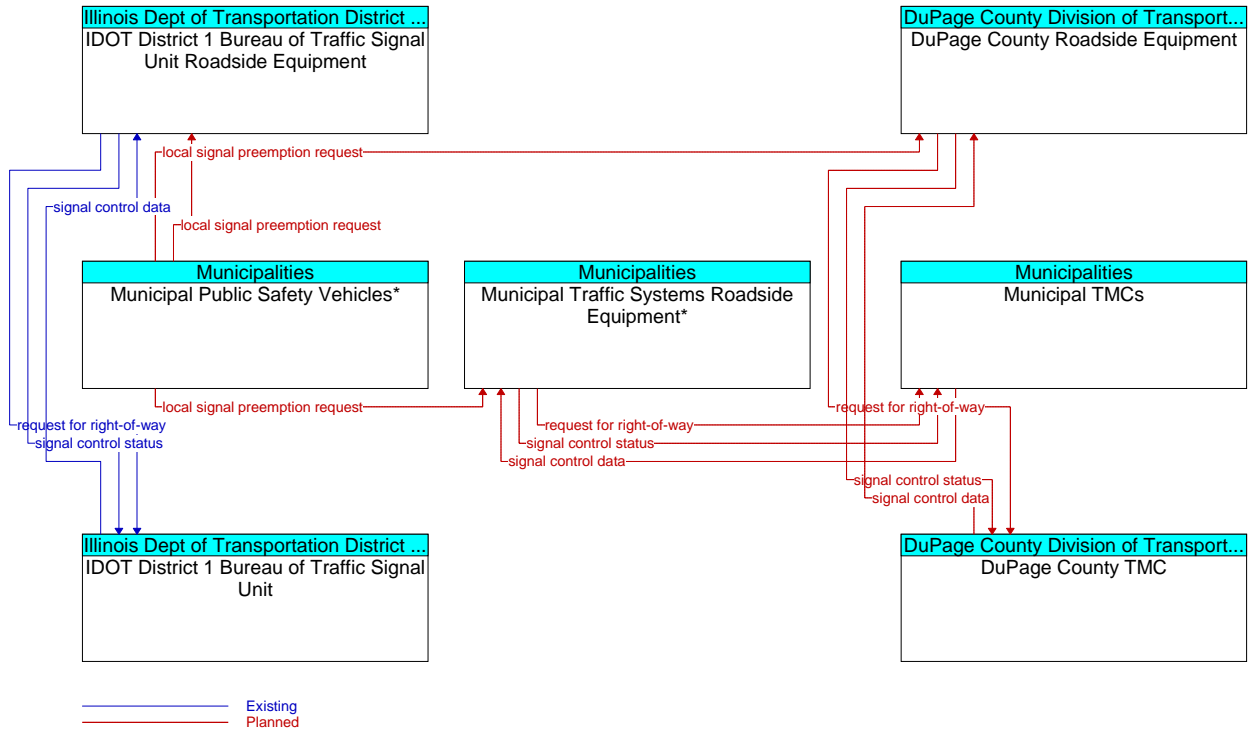
This project will plan, implement, operate, maintain and monitor coordinated signal preemption system across county for state, county and municipal systems. It may consider an interface with Glendale Heights EOC. The Market Packages provided by this project are

- Regional Traffic Control (ATMS07) and
- Emergency Routing (EM02).

The elements from the Regional ITS Architecture covered by this project are:

- Municipal Public Safety Vehicles (this element is not currently in the Regional ITS Architecture and would need to be added)
- Municipal Traffic Systems Roadside Equipment (this element is not currently in the Regional ITS Architecture and would need to be added)
- Municipal TMCs
- DuPage County Roadside Equipment
- DuPage County TMC
- IDOT District 1 Bureau of Traffic Signal Unit Roadside Equipment
- IDOT District 1 Bureau of Traffic Signal Unit

The interfaces and information flows from the Regional ITS Architecture that are covered by this project are shown in Figure A3-26. Note the interfaces with the Municipal Public Safety Vehicles are not in the current Regional ITS Architecture and will need to be added. Also the interface between Municipal TMCs and Municipal Traffic Systems Roadside Equipment are not covered in the current Regional ITS Architecture. Finally the suggested interface with Glendale Heights EOC (covered by element Municipal EMCs in the Regional ITS Architecture) is not included because of the undefined nature of the interface. This will need to be further defined as the project progresses.



**Figure A3-26: DuPage Emergency Management and Signal Preemption (ID 25)**

**A3-3.3 DuPage County Paratransit Coordination (ID 26)**

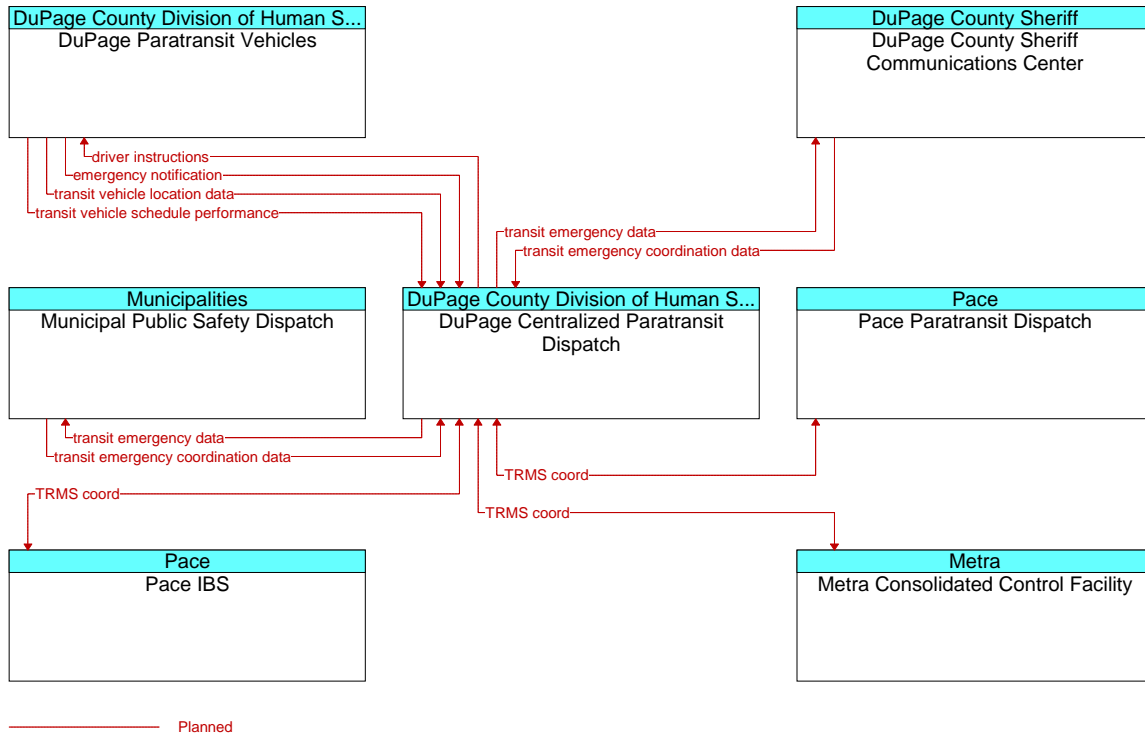
This project will look at implementing centralized coordination of local paratransit services as well as provide coordination with public safety and other transit organizations. The Market Packages provided by this project are:

- Demand Response Transit Operations (APTS3),
- Multimodal Coordination (APTS7) and
- Transit Security (APTS5).

The elements from the Regional ITS Architecture covered by this project are:

- DuPage Centralized Paratransit Dispatch
- DuPage Paratransit Vehicles
- DuPage County Sheriff Communications Center
- Municipal Public Safety Dispatch
- PACE Paratransit Dispatch
- PACE IBS
- Metra Consolidated Control Facility

The interfaces and information flows from the Regional ITS Architecture that are covered by this project are shown in Figure A3-27.



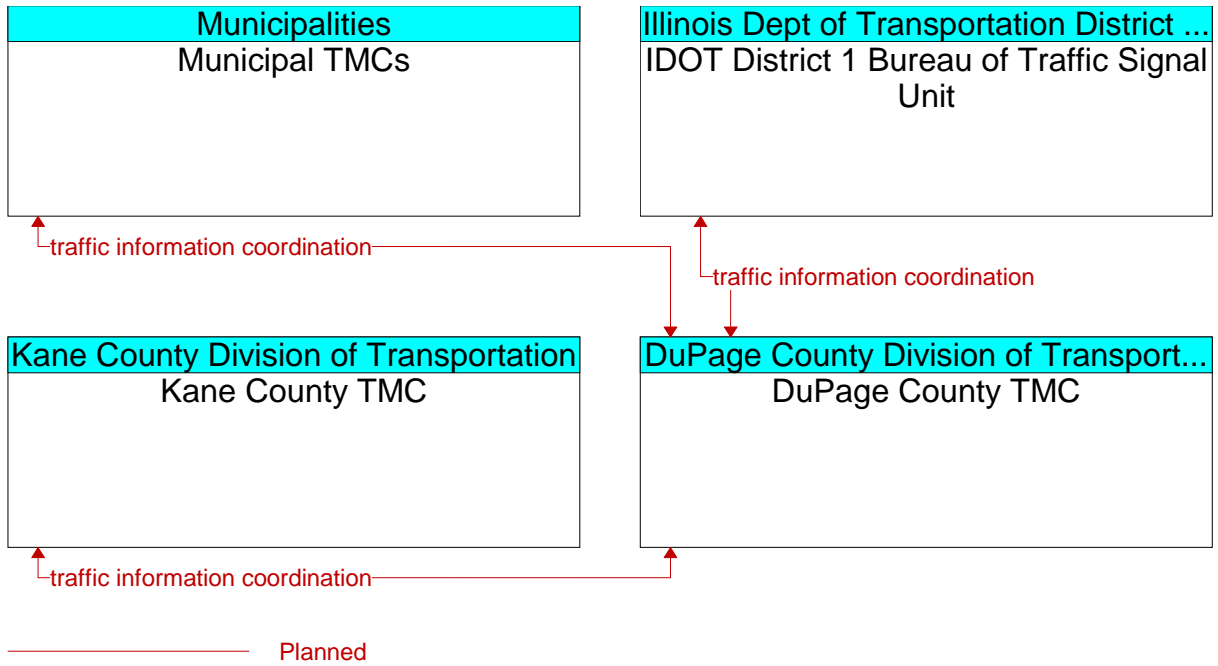
**Figure A3-27: DuPage County Paratransit Coordination (ID 26)**

**A3-3.4 DuPage County Signal Interconnects (ID 27)**

This project provides coordination between signal systems operated by DuPage County and those of adjacent jurisdictions. The Market Package provided by this project is Regional Traffic Control (ATMS07). The elements from the Regional ITS Architecture covered by this project are:

- DuPage County TMC
- IDOT District 1 Bureau of Traffic Signal Unit
- Kane County TMC
- Municipal TMCs

The interfaces and information flows from the Regional ITS Architecture that are covered by this project are shown in Figure A3-28.



**Figure A3-28: Interagency Signal Coordination- DuPage County (ID 27)**

### A3-4 Kane County Projects

#### A3-4.1 Kane County Traffic Management Center (ID 28)

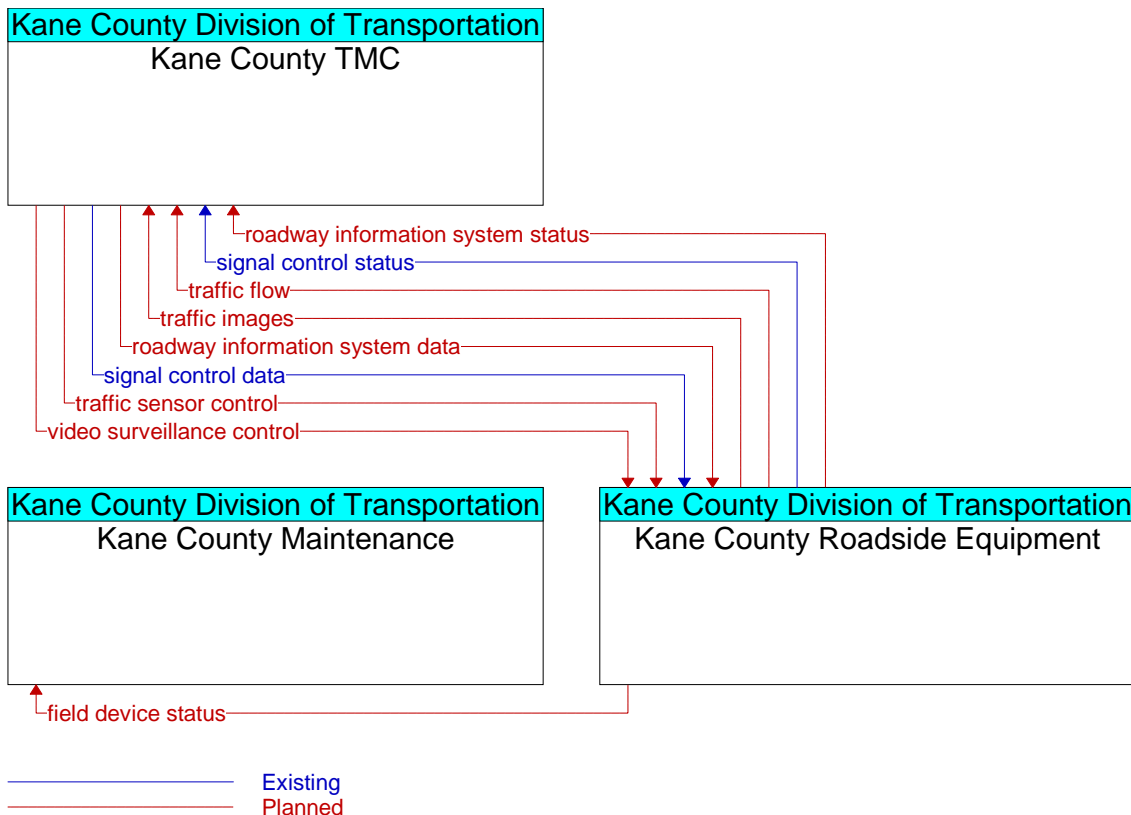
This project will implement basic traffic management capabilities for Kane County. The Market Packages covered by this project include

- Network Surveillance (ATMS01)
- Surface Street Control (ATMS03)
- Traffic Information Dissemination (ATMS06)
- Regional Traffic Control (ATMS07)
- Traffic Incident Management (ATMS08)

The elements from the Regional ITS Architecture covered by this project are:

- Kane County TMC
- Kane County Roadside Equipment
- Kane County Maintenance
- Other Regional Traffic Management Elements (see figure below)
- Regional Emergency Management Elements (see figure below)

The interfaces and information flows from the Regional ITS Architecture that are covered by this project are shown in Figure A3-29 through Figure A3-31.



**Figure A3-29: Kane County Traffic Management Center-Roadside Interfaces (ID 28)**

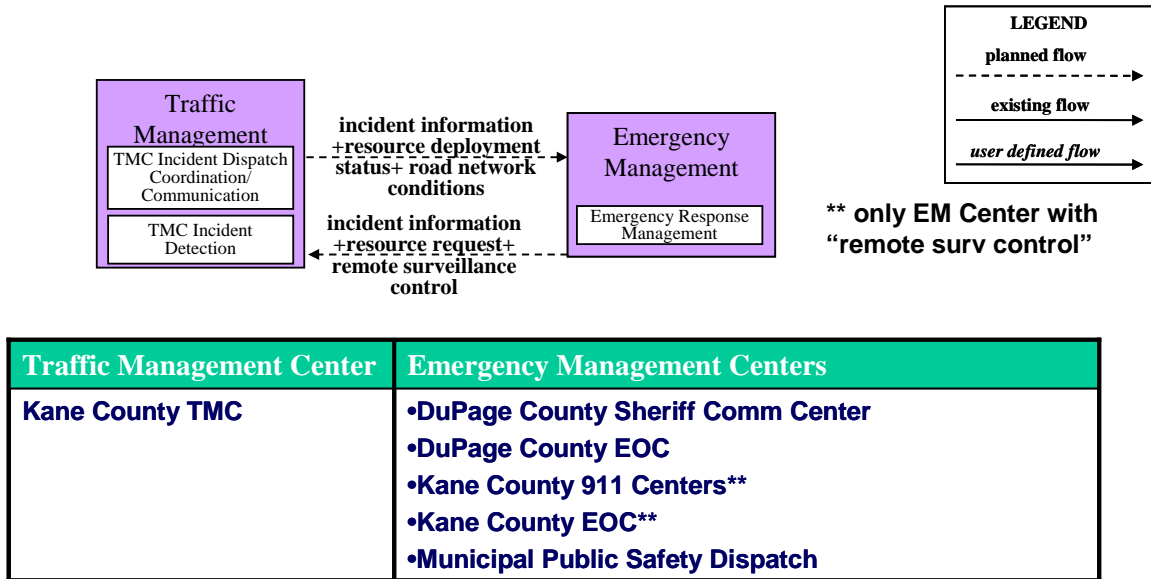
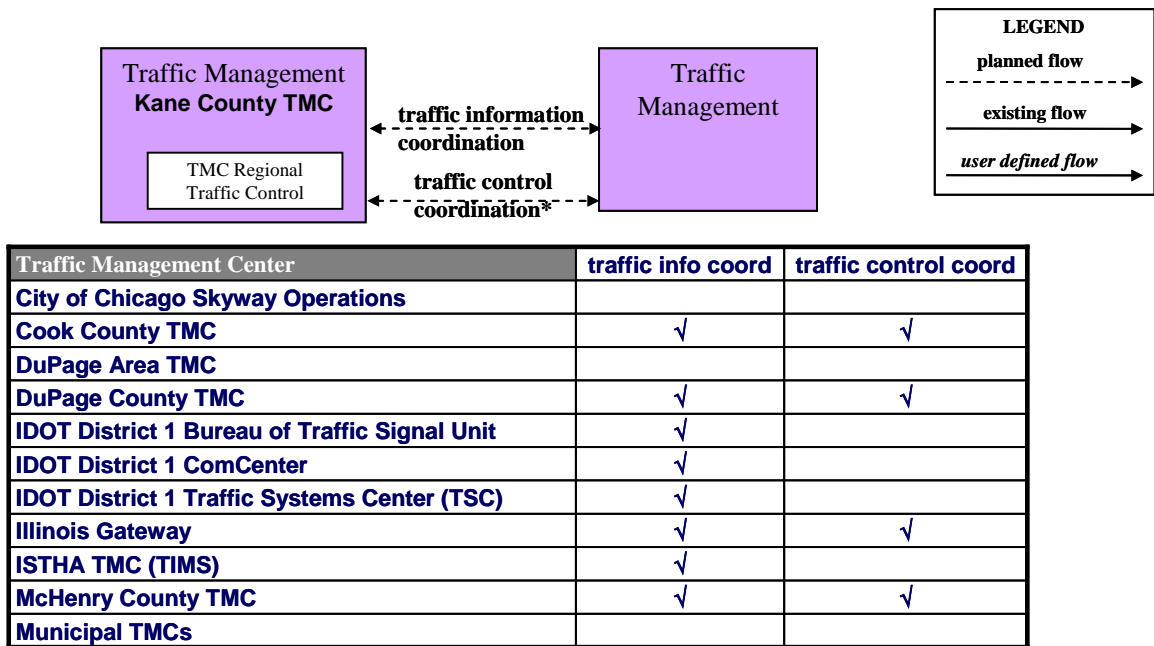


Figure A3-30: Kane County Traffic Management Center-Emergency Management



Interfaces (ID 28)

Figure A3-31: Kane County Traffic Management Center-Traffic Management Interfaces (ID 28)



### A3-4.2 Kane County Field Devices (ID 29)

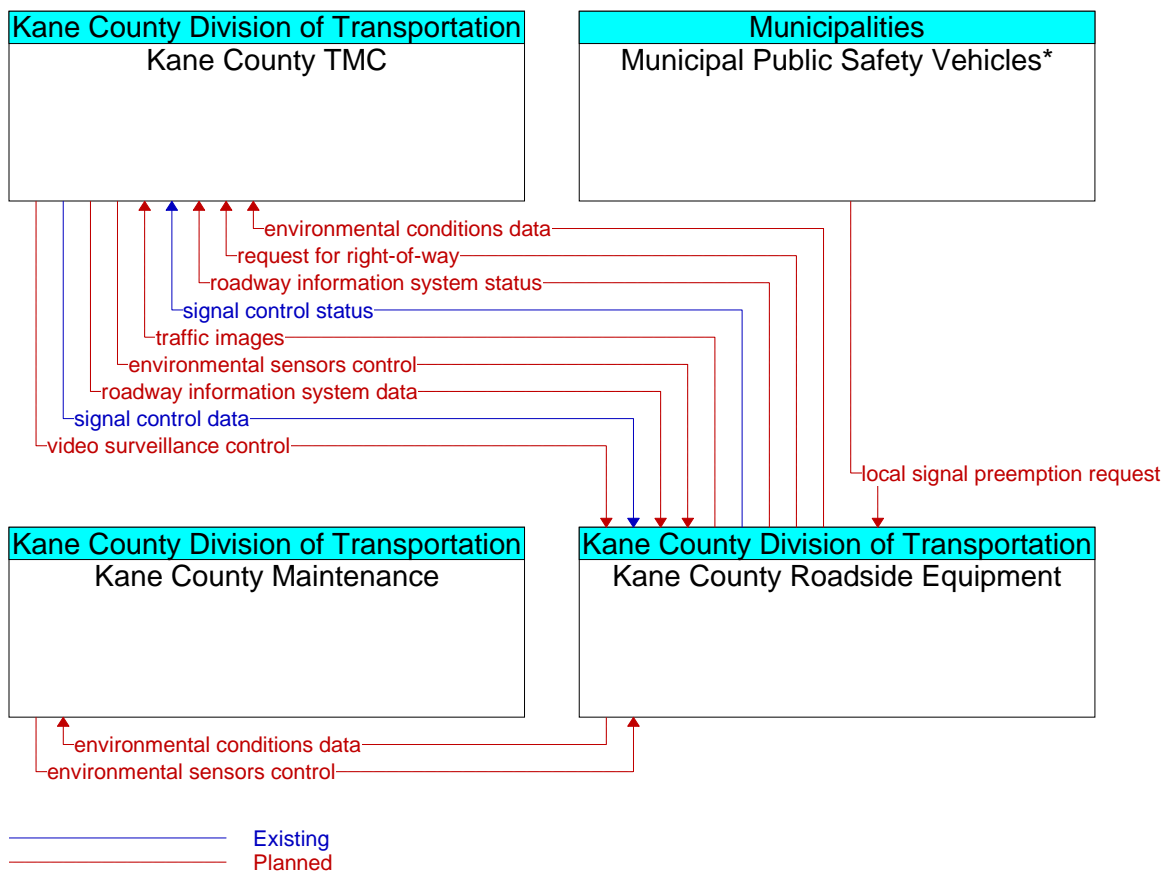
This project covers field device upgrades that are under consideration in Kane County. These include future RWIS devices and emergency vehicle preemption. The Market Packages covered by this project include:

- Network Surveillance (ATMS01)
- Traffic Information Dissemination (ATMS06)
- Emergency Routing (EM02) and
- Road Weather Data Collection (MC03).

The elements from the Regional ITS Architecture covered by this project are:

- Kane County TMC
- Kane County Roadside Equipment
- Kane County Maintenance
- Municipal Public Safety Vehicles (this element is not currently in the Regional ITS Architecture and would need to be added)

The interfaces and information flows from the Regional ITS Architecture that are covered by this project are shown in Figure A3-32.



**Figure A3-32: Kane County Field Devices (ID 29)**

### A3-4.3 Kane County Signal Interconnects (ID 30)

This project provides coordination between signal systems operated by Kane County and those of adjacent jurisdictions. The Market Packages provided by this project are

- Surface Street Control (ATMS03)
- Regional Traffic Control (ATMS07).

The elements from the Regional ITS Architecture covered by this project are:

- Kane County TMC
- Kane County Roadside Equipment
- DuPage County TMC
- IDOT District 1 Bureau of Traffic Signal Unit
- Municipal TMCs

The interfaces and information flows from the Regional ITS Architecture that are covered by this project are shown in Figure A3-33.

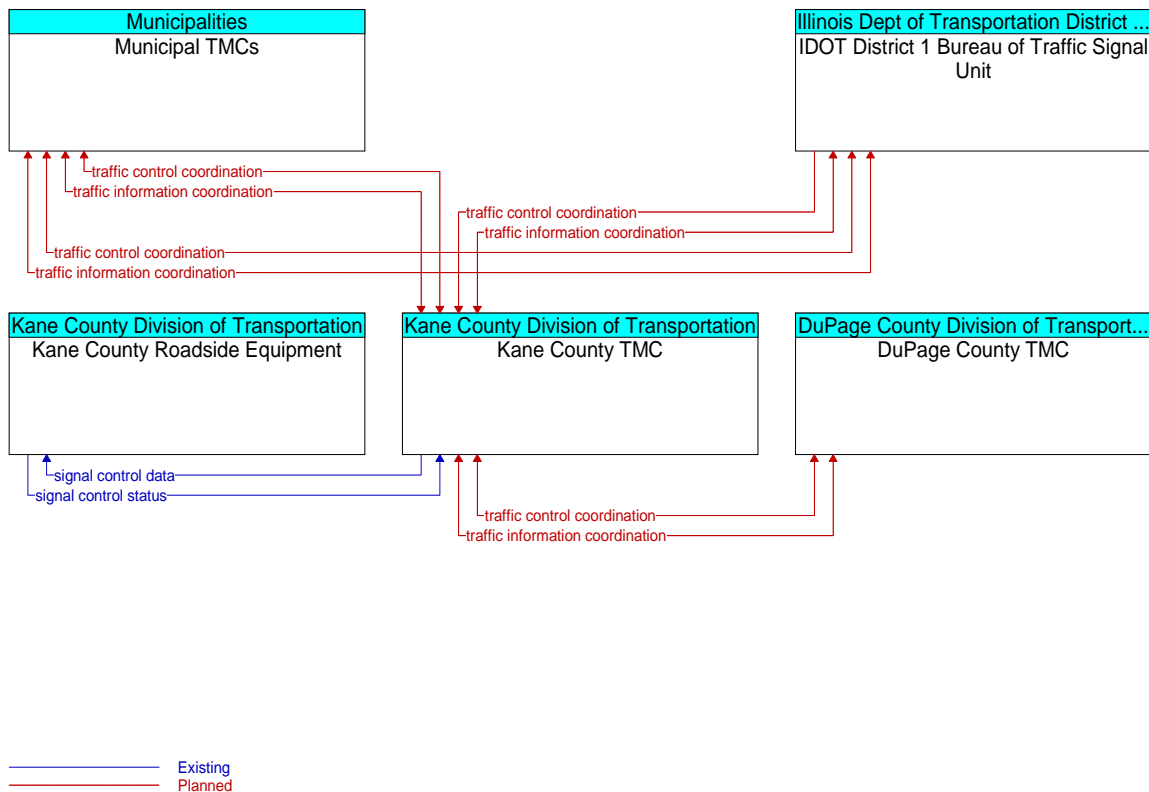


Figure A3-33: Kane County Signal Interconnects (ID 30)

## **A3-5 Lake County Projects**

### **A3-5.1 Lake County Traffic Management Center (ID 31)**

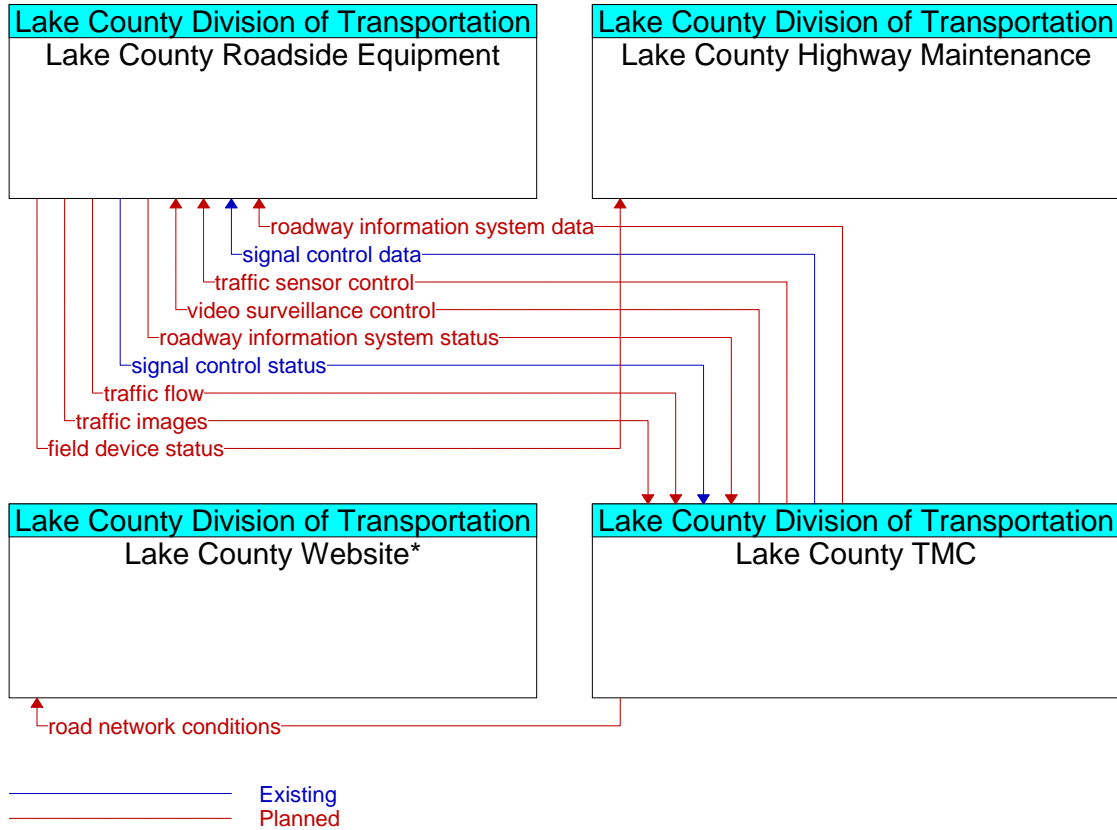
This project will continue the system implementation of the Lake County TMC. The initial phase will be 140+ signals. Two more phases are planned with automated diversion routes, a link to County Sheriff CAD, a link to the Gateway, and links to municipal TMCs, municipal public safety and County EOC. The Market Packages covered by this project include

- Network Surveillance (ATMS01)
- Surface Street Control (ATMS03)
- Traffic Information Dissemination (ATMS06)
- Regional Traffic Control (ATMS07)
- Incident Management (ATMS08)

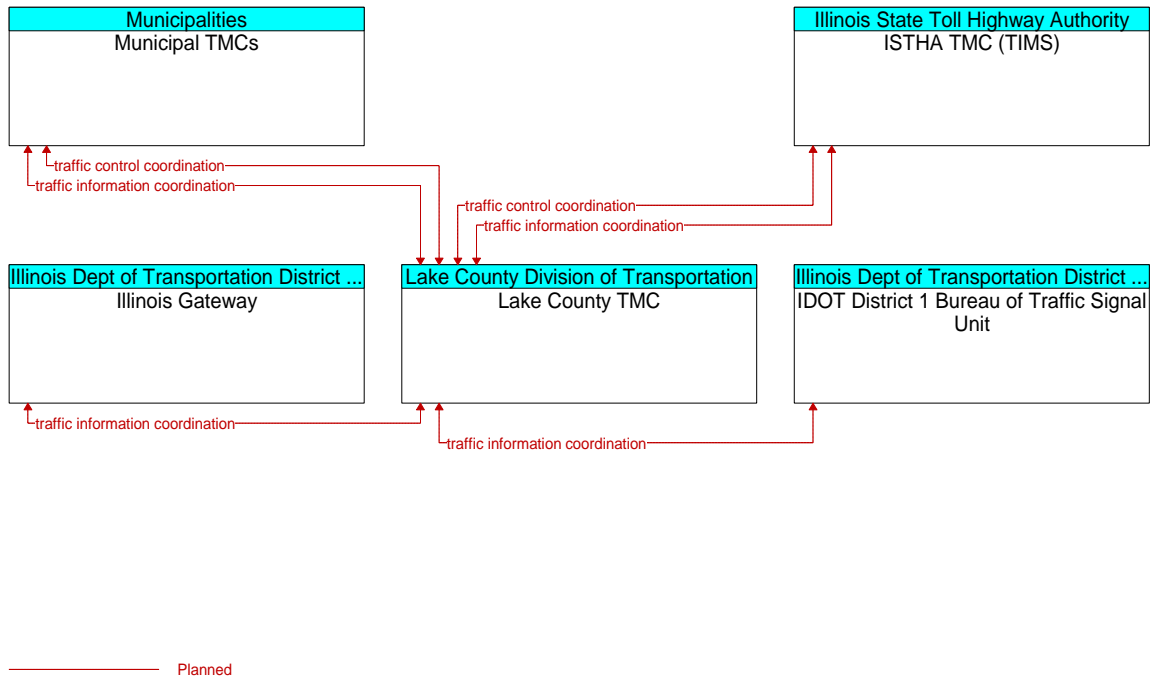
The elements from the Regional ITS Architecture covered by this project are:

- Lake County TMC
- Lake County Roadside Equipment
- Lake County Website (this element is not currently in the Regional ITS Architecture and would need to be added)
- Lake County Maintenance
- Lake County Communications Center
- Lake County EOC
- Municipal Public Safety Dispatch
- IDOT District 1 Bureau of Traffic Signal Unit
- ISTHA TIMS

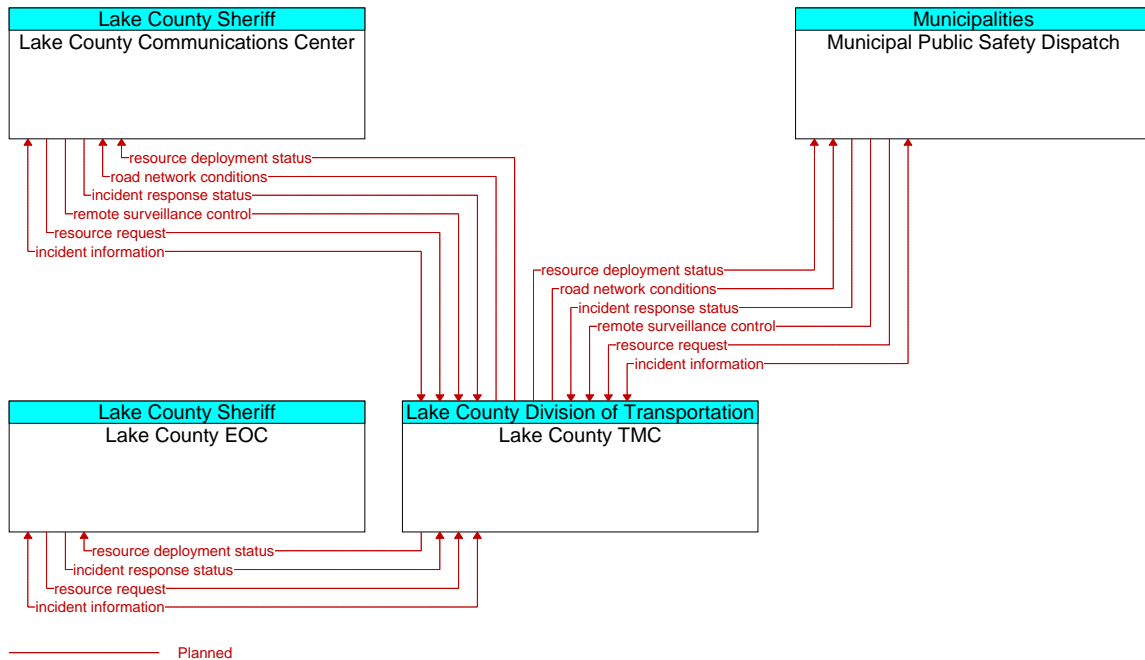
The interfaces and information flows from the Regional ITS Architecture that are covered by this project are shown in Figure A3-34 through Figure A3-36. Note the element Lake County Website (and its interfaces) is not in the current Regional ITS Architecture and would need to be added. Also interfaces between the Lake County TMC and Municipal TMCs, Municipal Public Safety Dispatch, and Lake County EOC as well as the traffic control coordination flows to and from IDOT District 1 Bureau of Traffic Signal Unit and ISTHA TIMS are not in the current Regional ITS Architecture and would need to be added.



**Figure A3-34: Lake County Traffic Management Center- Roadside Interfaces (ID 31)**



**Figure A3-35: Lake County Traffic Management Center- Traffic Management Interfaces (ID 31)**



**Figure A3-36: Lake County Traffic Management Center- Emergency Management Interfaces (ID 31)**

**A3-5.2 Lake County Field Devices (ID 32)**

This project will provide CCTV surveillance of Lake County roadways, HAR, RWIS, and both portable and permanent DMS. Additional consideration is being given to transit signal priority and wireless connections to outlying signals. The Market Packages covered by this project include:

- Network Surveillance (ATMS01)
- Traffic Information Dissemination (ATMS06)
- Multimodal Coordination (APTS7) and
- Road Weather Data Collection (MC03).

The elements from the Regional ITS Architecture covered by this project are:

- Lake County TMC
- Lake County Roadside Equipment
- Lake County Maintenance
- Pace Transit Bus Vehicles

The interfaces and information flows from the Regional ITS Architecture that are covered by this project are shown in Figure A3-37. Note the environmental conditions data/control flows are not currently in the Regional ITS Architecture and would need to be added.

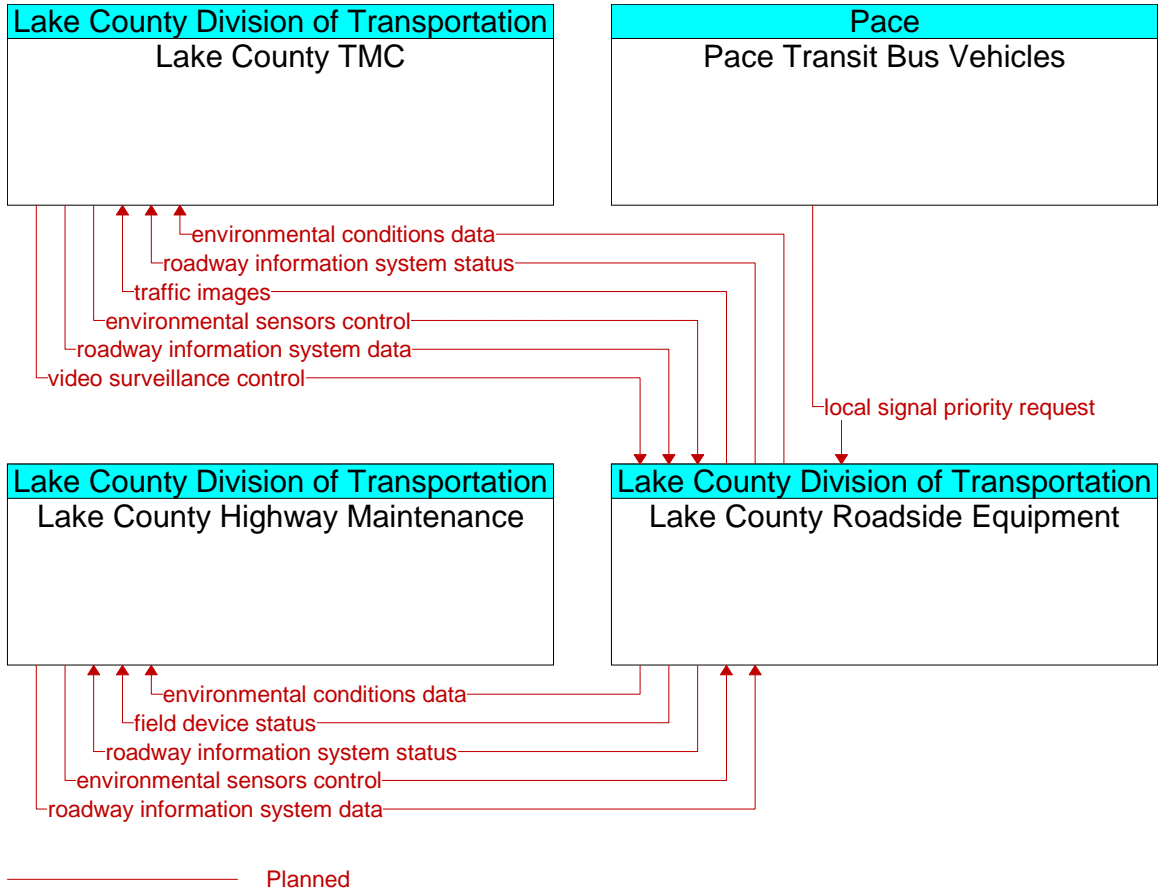


Figure A3-37: Lake County Field Devices (ID 32)

### A3-5.3 Lake County Signal Interconnects (ID 33)

This project provides coordination of signals on county highways. May include signal timing across municipal and county boundaries. The Market Packages provided by this project are:

- Surface Street Control (ATMS03) and
- Regional Traffic Control (ATMS07).

The elements from the Regional ITS Architecture covered by this project are:

- Lake County TMC
- Lake County Roadside Equipment
- IDOT District 1 Bureau of Traffic Signal Unit
- Municipal TMCs

The interfaces and information flows from the Regional ITS Architecture that are covered by this project are shown in Figure A3-38.

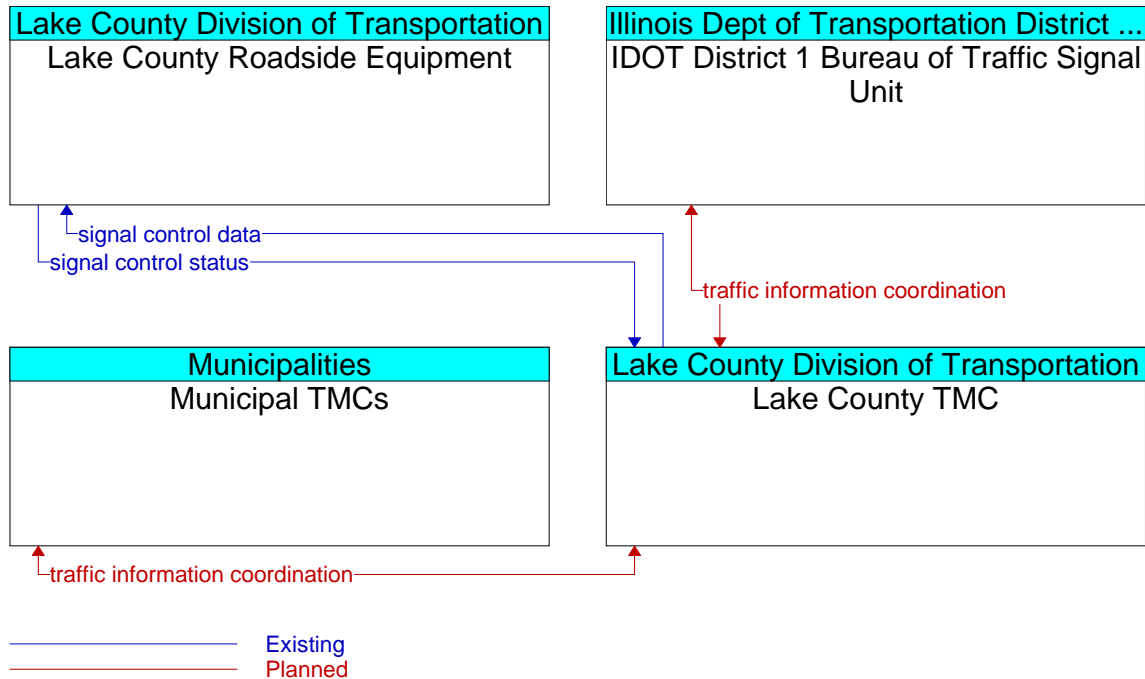


Figure A3-38: Lake County Signal Interconnects (ID 33)

### A3-6 McHenry County Projects

#### A3-6.1 McHenry County Traffic Management Center (ID 34)

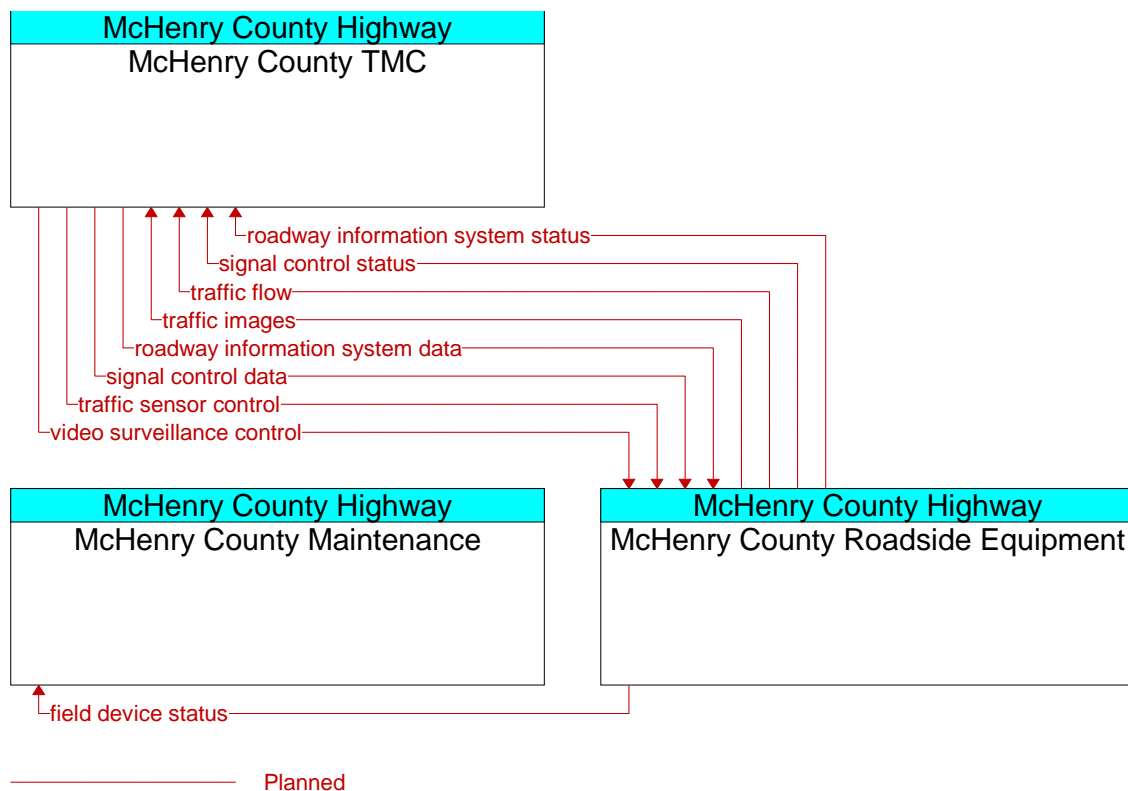
This project would provide a traffic management capability for McHenry County. The Market Packages covered by this project include:

- Network Surveillance (ATMS01)
- Surface Street Control (ATMS03)
- Traffic Information Dissemination (ATMS06)
- Regional Traffic Control (ATMS07)
- Traffic Incident Management (ATMS08)

The elements from the Regional ITS Architecture covered by this project are:

- McHenry County TMC
- McHenry County Roadside Equipment
- McHenry County Maintenance

The interfaces and information flows from the Regional ITS Architecture that are covered by this project are shown in Figure A3-39 through Figure A3-41. The latter two figures represent possible traffic management and emergency management interfaces, although the actual interfaces developed will be decided by a planned feasibility study.



**Figure A3-39: McHenry County Traffic Management Center- Roadside Interfaces (ID 34)**



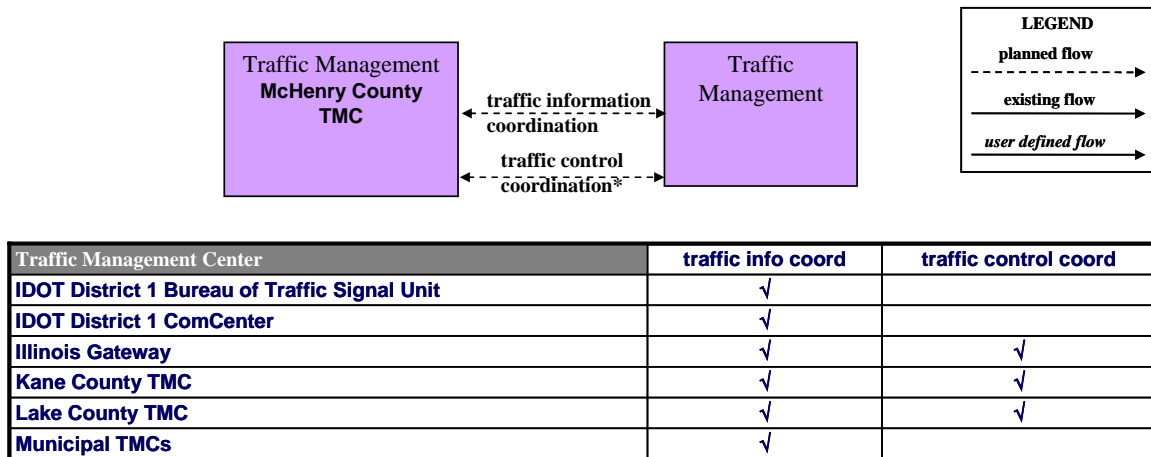


Figure A3-40: McHenry County Traffic Management Center- Traffic Management Interfaces (ID 34)

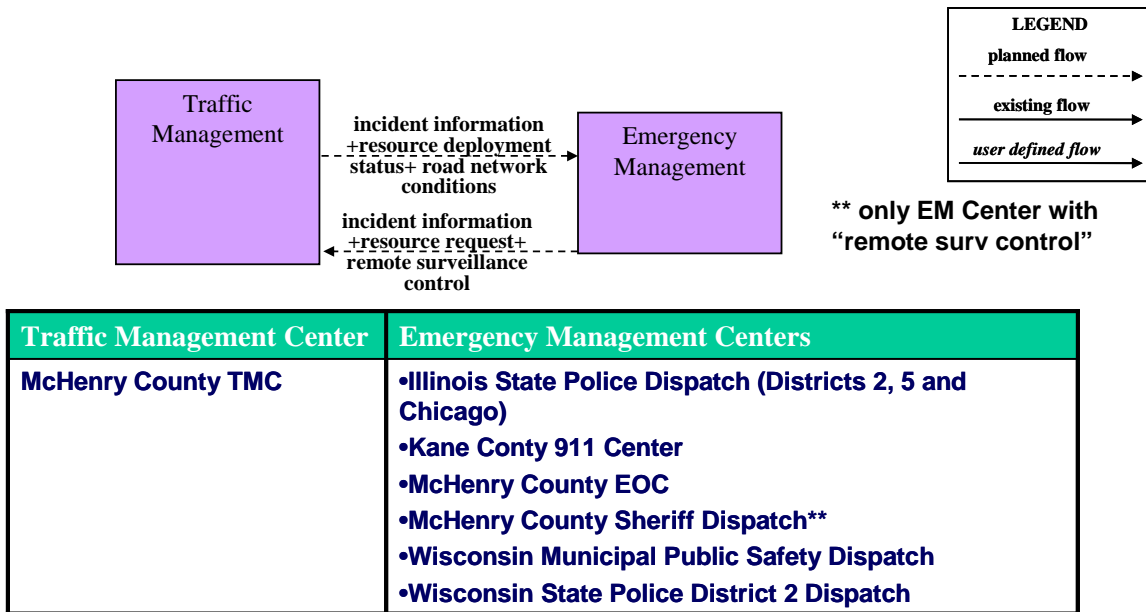


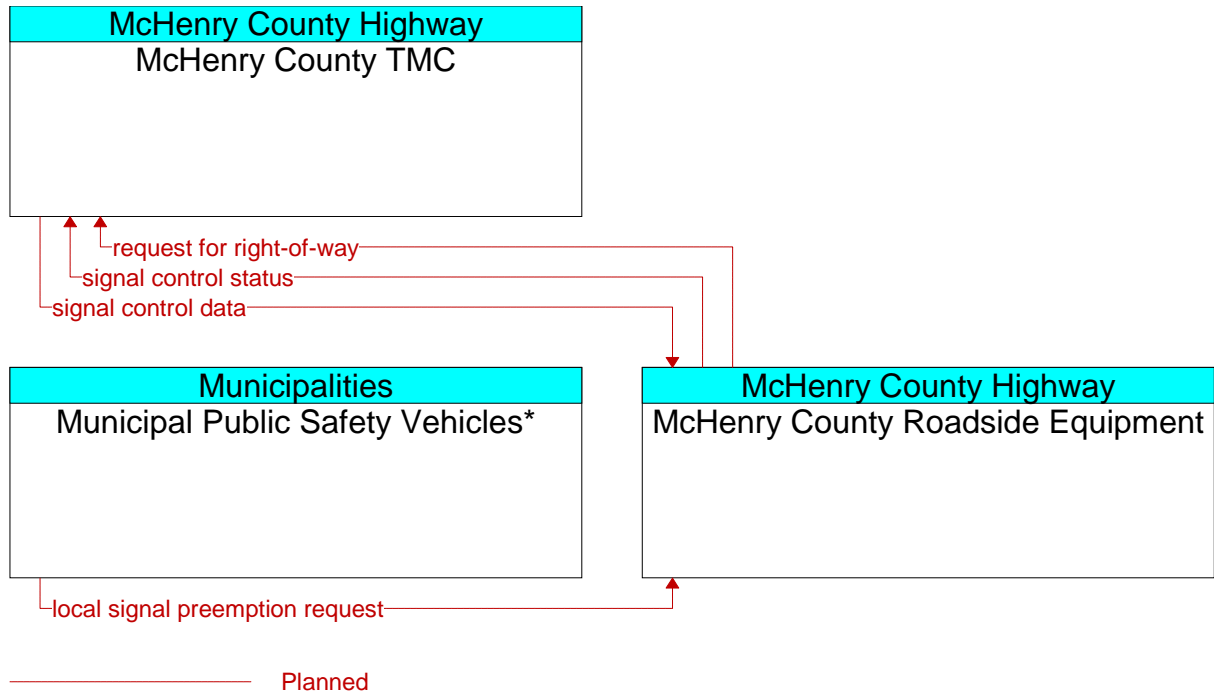
Figure A3-41: McHenry County Traffic Management Center- Emergency Management Interfaces (ID 34)

**A3-6.2 McHenry County Field Devices (ID 35)**

This project includes Emergency Vehicle Preemption on signals. The Market Package covered by this project includes Emergency Routing. The elements from the Regional ITS Architecture covered by this project are:

- McHenry County TMC
- McHenry County Roadside Equipment
- Municipal Public Safety Vehicles\* (this element is not currently in the Regional ITS Architecture and would need to be added)

The interfaces and information flows from the Regional ITS Architecture that are covered by this project are shown in Figure A3-42.



**Figure A3-42: McHenry County Field Devices (ID 35)**

**A3-6.3 McHenry County Signal Interconnects (ID 36)**

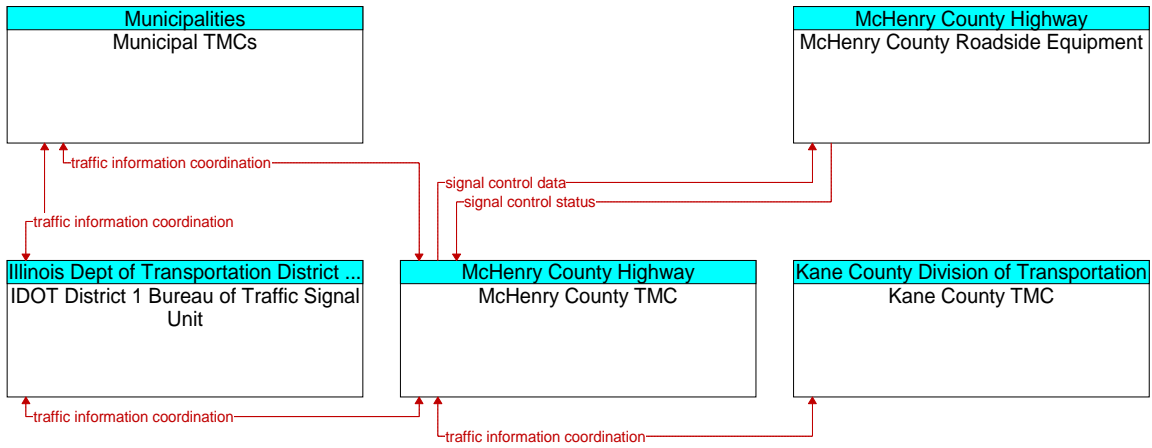
This project provides coordination of signals on county highways. It may include signal timing across municipal and county boundaries. The Market Packages provided by this project are:

- Surface Street Control (ATMS03)
- Regional Traffic Control (ATMS07).

The elements from the Regional ITS Architecture covered by this project are:

- McHenry County TMC
- McHenry County Roadside Equipment
- Kane County TMC
- IDOT District 1 Bureau of Traffic Signal Unit
- Municipal TMCs

The interfaces and information flows from the Regional ITS Architecture that are covered by this project are shown in Figure A3-43.



— Planned

**Figure A3-43: McHenry County Signal Interconnects (ID 36)**

### A3-7 Will County Projects

#### A3-7.1 Will County Traffic Management Center (ID 37)

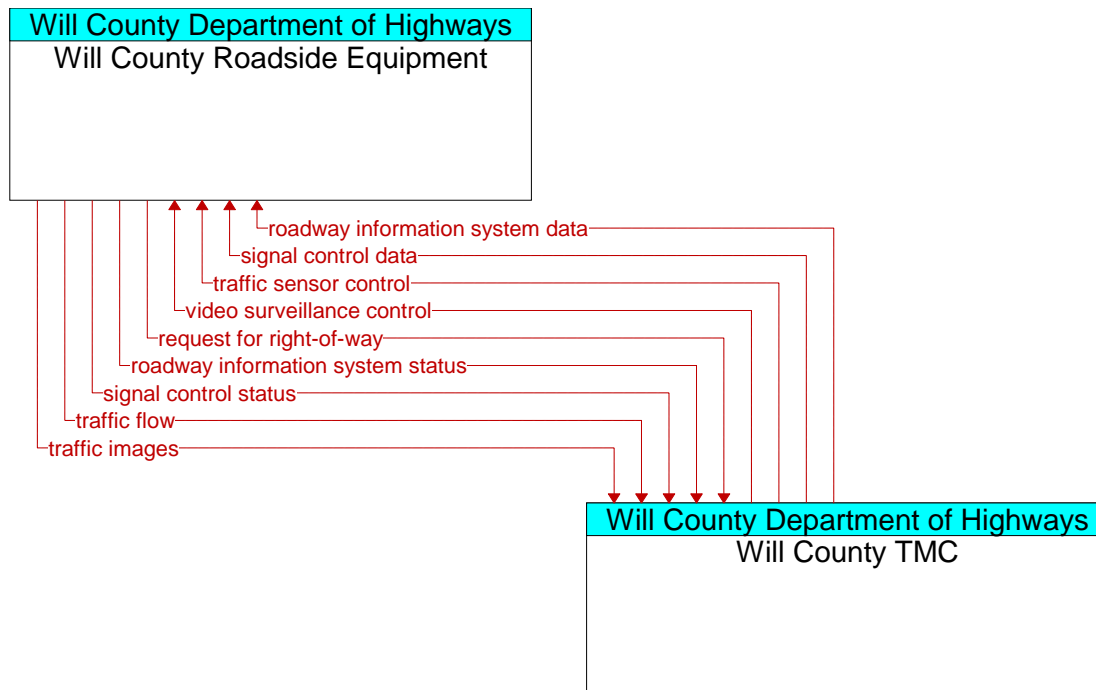
This project involves the development of traffic management capabilities for the county. One consideration for this TMS is the collocation traffic management and emergency operations centers. The Market Packages covered by this project include:

- Network Surveillance (ATMS01)
- Surface Street Control (ATMS03)
- Traffic Information Dissemination (ATMS06)
- Regional Traffic Control (ATMS07)
- Traffic Incident Management (ATMS08)

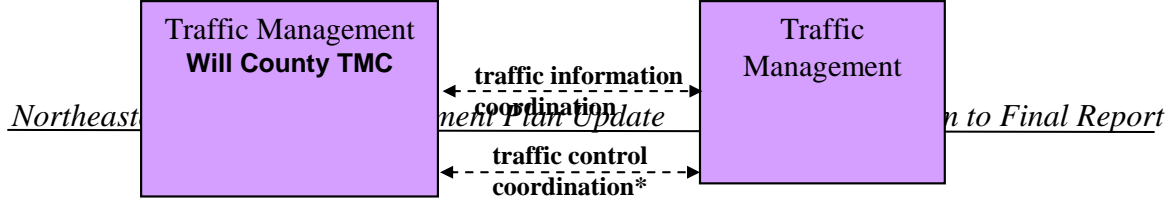
The elements from the Regional ITS Architecture covered by this project are:

- Will County TMC
- Will County Roadside Equipment
- Other Regional Traffic Management Elements (see figure below)
- Regional Emergency Management Elements (see figure below)

The interfaces and information flows from the Regional ITS Architecture that are covered by this project are shown Figure A3-44 through A3-46. The latter two figures represent possible traffic management and emergency management interfaces, although the actual interfaces developed will be decided by a feasibility study.

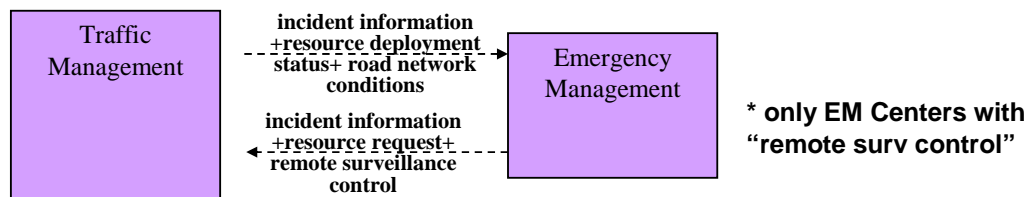


**Figure A3-44: Will County Traffic Management Center-Roadside Interface (ID 37)**



Traffic Management Center	traffic info coord	traffic control coord
Cook County TMC	√	
DuPage County TMC	√	
IDOT District 1 Bureau of Traffic Signal Unit	√	
IDOT District 1 ComCenter	√	
IDOT District 1 Traffic Systems Center (TSC)	√	
Illinois Gateway	√	√
Indiana DOT Arterial TMC	√	
ISTHA TMC (TIMS)	√	
Municipal TMCs	√	
Satellite South Suburban Airport TMC	√	

Figure A3-45: Will County Traffic Management Center-Traffic Management Interfaces (ID 37)



Traffic Management Center	Emergency Management Centers
Will County TMC	<ul style="list-style-type: none"> <li>•Cook County Sheriff Communications Center</li> <li>•DuPage County Sheriff Comm Center</li> <li>•IDOT District 1 Com Center</li> <li>•Illinois State Police Dispatch (District 2,5, Chicago)</li> <li>•Illinois State Police District 15 Operations Desk</li> <li>•Indiana County/Municipal Public Safety Dispatch</li> <li>•Indiana State Police Dispatch</li> <li>•ISTHA Dispatch Center</li> <li>•Municipal Public Safety Dispatch</li> <li>•Will County Sheriff Communications Center *</li> <li>•Will County EOC</li> </ul>

Figure A3-46: Will County Traffic Management Center-Emergency Management Interfaces (ID 37)

### **A3-7.2 Will County Field Devices (ID 38)**

This project includes the implementation of field devices and connections to centers for the following functions: monitoring of closed loop signal systems, emergency vehicle preemption, both arterial surveillance (e.g. CCTV) and information to travelers (e.g. DMS) at expressway interchanges, portable DMS, and video in police vehicles. The Market Packages covered by this project include:

- Network Surveillance (ATMS01)
- Surface Street Control (ATMS03)
- Traffic Information Dissemination (ATMS06)
- Traffic Incident Management (ATMS08) and
- Emergency Routing (EM02)

The elements from the Regional ITS Architecture covered by this project are:

- Will County TMC
- Will County Roadside Equipment
- Will County Maintenance
- Will County Sheriff Vehicles (This is an element not in the Regional ITS Architecture that will need to be added)
- Municipal Public Safety Vehicles (This is an element not in the Regional ITS Architecture that will need to be added)
- Will County Sheriff Communications Center

The interfaces and information flows from the Regional ITS Architecture that are covered by this project are shown in Figure A3-47. The element Will County Sheriff Vehicles and the video images interfaces are not in the current Regional ITS Architecture and will need to be added. Also not in the current Regional ITS Architecture is the interface between Will County Maintenance and the Roadside Equipment, and the signal preemption interface from Will County Roadside Equipment to Municipal Public Safety Vehicles.

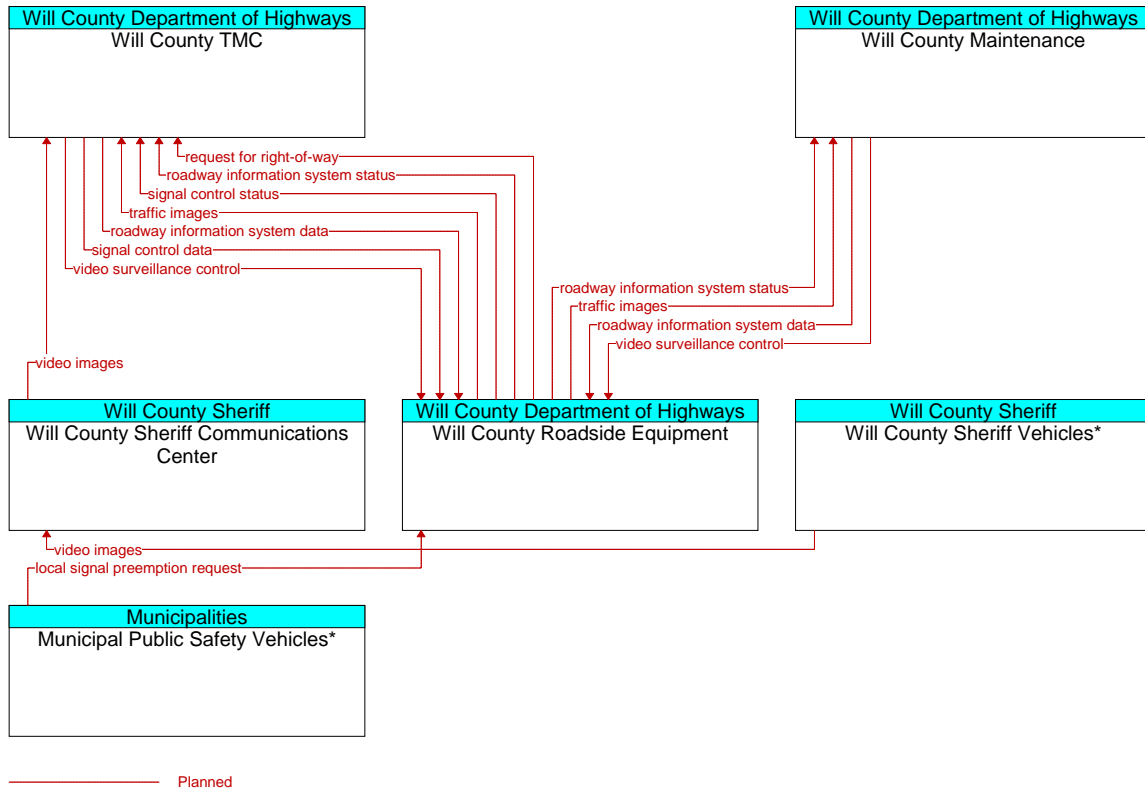


Figure A3-47: Will County Field Devices (ID 38)

### A3-7.3 Will County Signal Interconnects (ID 39)

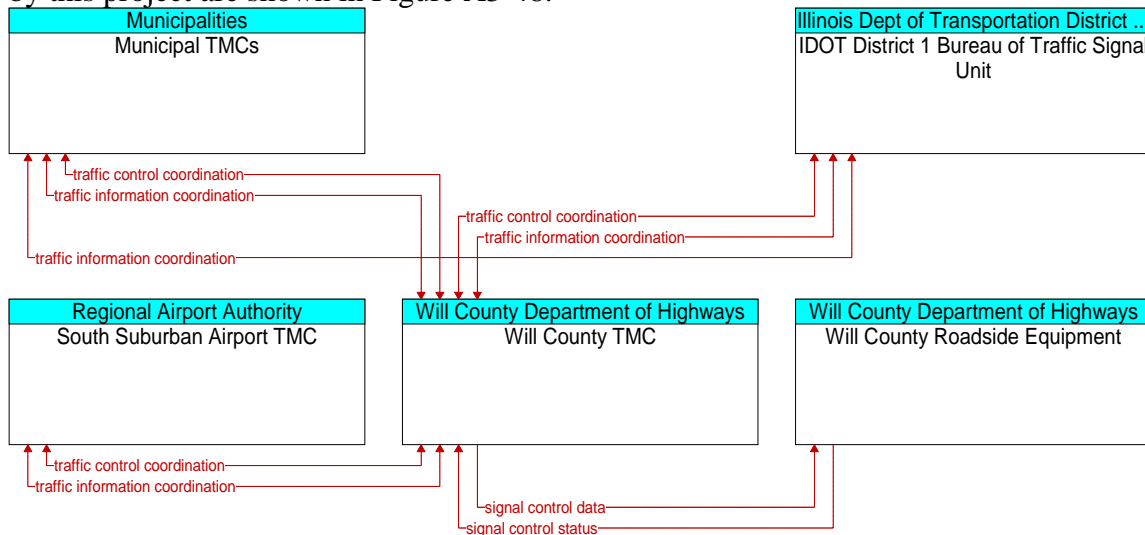
This project provides coordination of signals on county highways. The project may include signal timing across municipal and county boundaries. The Market Packages provided by this project are:

- Surface Street Control (ATMS03)
- Regional Traffic Control (ATMS07)

The elements from the Regional ITS Architecture covered by this project are:

- Will County TMC
- IDOT District 1 Bureau of Traffic Signal Unit
- Municipal TMCs
- South Suburban Airport TMC

The interfaces and information flows from the Regional ITS Architecture that are covered by this project are shown in Figure A3-48.



Planned

**Figure A3-48: Will County Signal Interconnects (ID 39)**



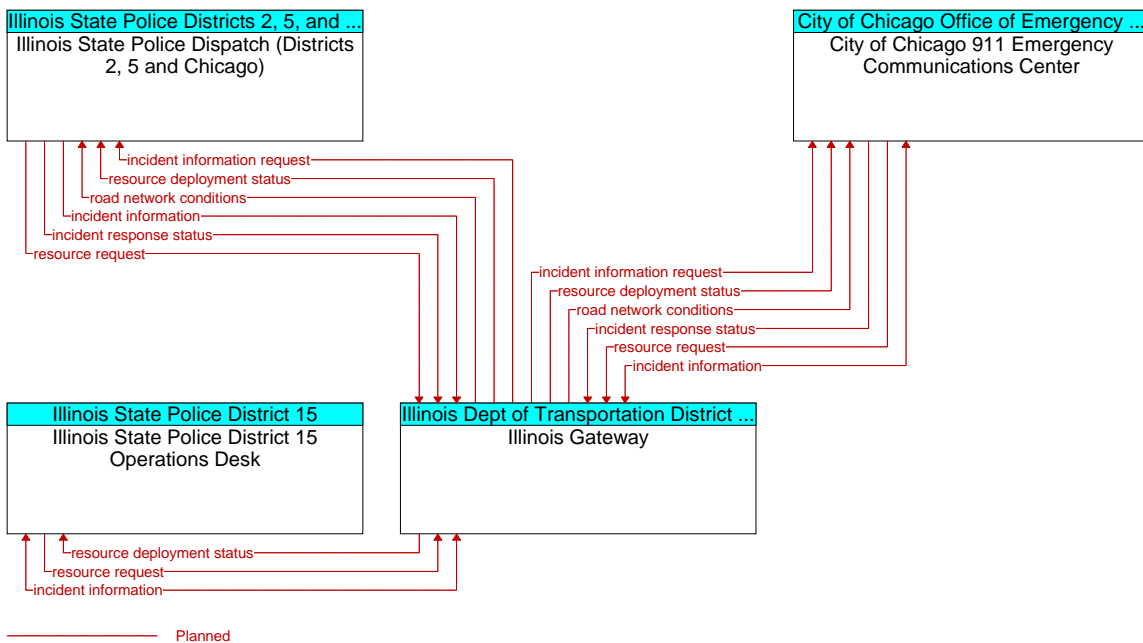
### A3-8 IDOT Projects

#### A3-8.1 Integration of Centers (ID 41)

This project will connect regional police districts (Il State Police and Chicago) to Gateway Traveler Information System in order to share incident and other information. This project will support the implementation of the Market Package Traffic Incident Management System (ATMS08). From an architecture standpoint this project involves connections to the Illinois Gateway from the following elements:

- City of Chicago 911 Emergency Communications Center
- Illinois State Police Dispatch (Districts 2, 5 and Chicago)
- Illinois State Police District 15 Operations Desk
- Illinois Gateway

The interfaces and information flows from the Regional ITS Architecture that are covered by this project are shown in Figure A3-49. Additional interfaces to other emergency management elements may be added as the project develops.



**Figure A3-49: Integration of Centers (ID 41)**

### **A3-8.2 Interagency Operations and Signal Coordination (ID 42)**

This project will consider the coordination of signals on Strategic Regional Arterials throughout NE Illinois. This includes coordination from IDOT District 1 Bureau of Traffic Signal Unit to other traffic management elements in the architecture. Note that the possibility exists for additional interagency signal coordination not involving IDOT (e.g. between county and municipal signal systems). This type of coordination not involving IDOT is covered in these other projects (and the mapping to architecture is given there).

- City of Chicago Interconnects (ID 11)
- Cook County Signal Interconnects (ID 23)
- DuPage County Signal Interconnects (ID 27)
- Kane County Signal Interconnects (ID 30)
- Lake County Signal Interconnects (ID 33)
- McHenry County Signal Interconnects (ID 36)
- Will County Signal Interconnects (ID 39)

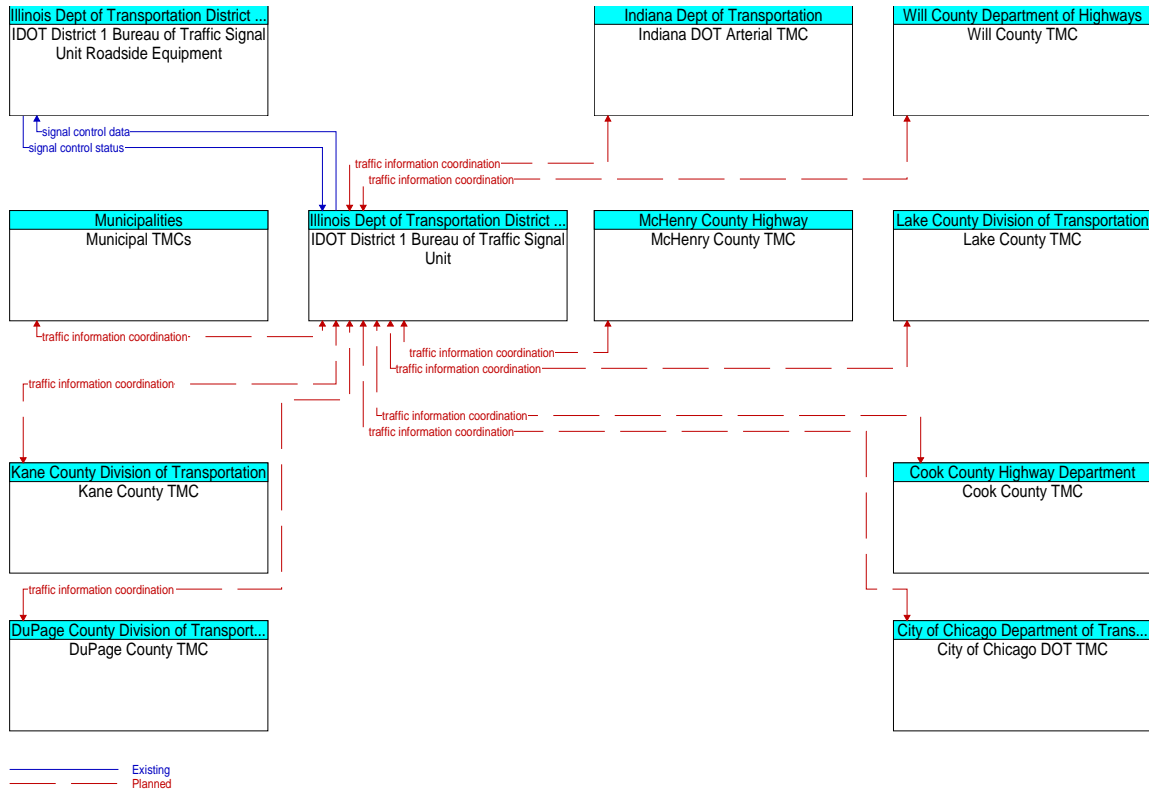
The Market Packages provided by this project are:

- Surface Street Control (ATMS03)
- Regional Traffic Control (ATMS07).

From an architecture standpoint, this project involves connections between the IDOT District 1 Bureau of Traffic Signal Unit and the following elements:

- Cook County TMC
- City of Chicago DOT TMC
- DuPage County TMC
- Indiana DOT Arterial TMC
- Kane County TMC
- Lake County TMC
- McHenry County TMC
- Municipal TMCs (e.g. traffic operations in Naperville or Aurora)
- Will County TMC

The interfaces and information flows from the Regional ITS Architecture that are covered by this project are shown in Figure A3-50.



**Figure A3-50: Interagency Operations and Signal Coordination (ID 42)**

**A3-8.3 IDOT Signal Interconnects (ID 43)**

This project includes coordination of signals on state highways. It may include signal timing across municipal and county boundaries as well as centralized traffic control of signals. From an architecture standpoint this project has the same market packages, elements and interfaces as the previous project, Interagency Operations and Signal Coordination (ID 42).

**A3-8.4 Suburban Chicago ATMS - Centralized Traffic Control (ID 44)**

This project involves creation of a traffic management capability for Chicago northwest suburbs. The TMC will handle coordination of over 200 signals within IL 62, Arlington Heights Rd, US 20 & Barrington Rd. It will also include video monitoring and detection. The project involves IDOT Dist. 1, Cook County Hwy Dept and Schaumburg. Future enhancements would add other elements such as DMS and transit signal priority. Since this is an IDOT project, this could involve an expansion of the capabilities of an element in the current Regional ITS Architecture, IDOT District 1 Bureau of Traffic Signal Unit, or it could involve creation of a new element (e.g. IDOT District 1 Northwest Suburbs TMC). The following description of the project assumes the former approach. If the latter approach is taken, then the Regional ITS Architecture would need to be updated to include the new element.

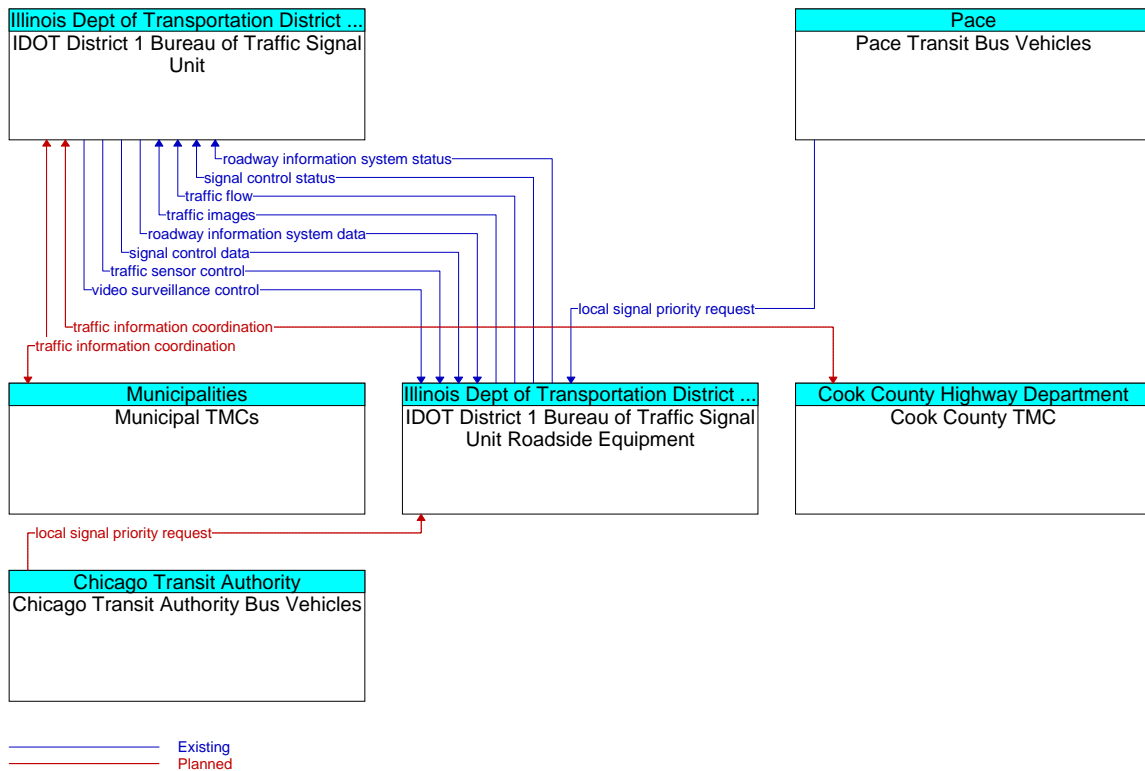
The Market Packages provided by this project are:

- Network Surveillance (ATMS01)
- Surface Street Control (ATMS03)
- Traffic Information Dissemination (ATMS06)
- Regional Traffic Control (ATMS07)
- Traffic Incident Management (ATMS08)
- Multimodal Coordination (APTS7)

From an architecture standpoint, this project involves connections between the following elements:

- IDOT District 1 Bureau of Traffic Signal Unit
- IDOT District 1 Bureau of Traffic Signal Unit Roadside Equipment
- Cook County TMC
- Municipal TMCs (e.g. traffic operations in Schaumburg)
- Chicago Transit Authority Bus Vehicles
- Pace Transit Bus Vehicles

The interfaces and information flows from the Regional ITS Architecture that are covered by this project are shown in Figure A3-51.



**Figure A3-51: Suburban Chicago ATMS - Centralized Traffic Control (ID 44)**

### A3-8.5 CCTV Surveillance Sharing (ID 48)

This project considers sharing of video information among traffic management elements in the region. Several ways of implementing this capability are being considered. These include use of the internet with password protected access to images and control of the cameras. The agencies involved could include both public and private agencies through some sort of partnership. The IDOT elements involved in the project are the IDOT District 1 COM Center, the IDOT District 1 Traffic Systems Center (TSC), and to a lesser extent the IDOT District 1 Bureau of Traffic Signal Unit. Other elements involved in the video sharing would include ISTHA TMC (TIMS) and the City of Chicago DOT TMC. The market package provided by this project is Traffic Incident Management (ATMS08).

The interfaces and information flows from the Regional ITS Architecture that are covered by this project are shown in Figure A3-52. Because of the high level nature of the Regional ITS Architecture, the video sharing information is contained as a part of the information flow “traffic information coordination”. Also the Regional ITS Architecture shows direct interconnect between the centers, but doesn’t really describe the idea of a web-based interface for video sharing and control. If this approach is used, then the Regional ITS Architecture should be updated to reflect it.

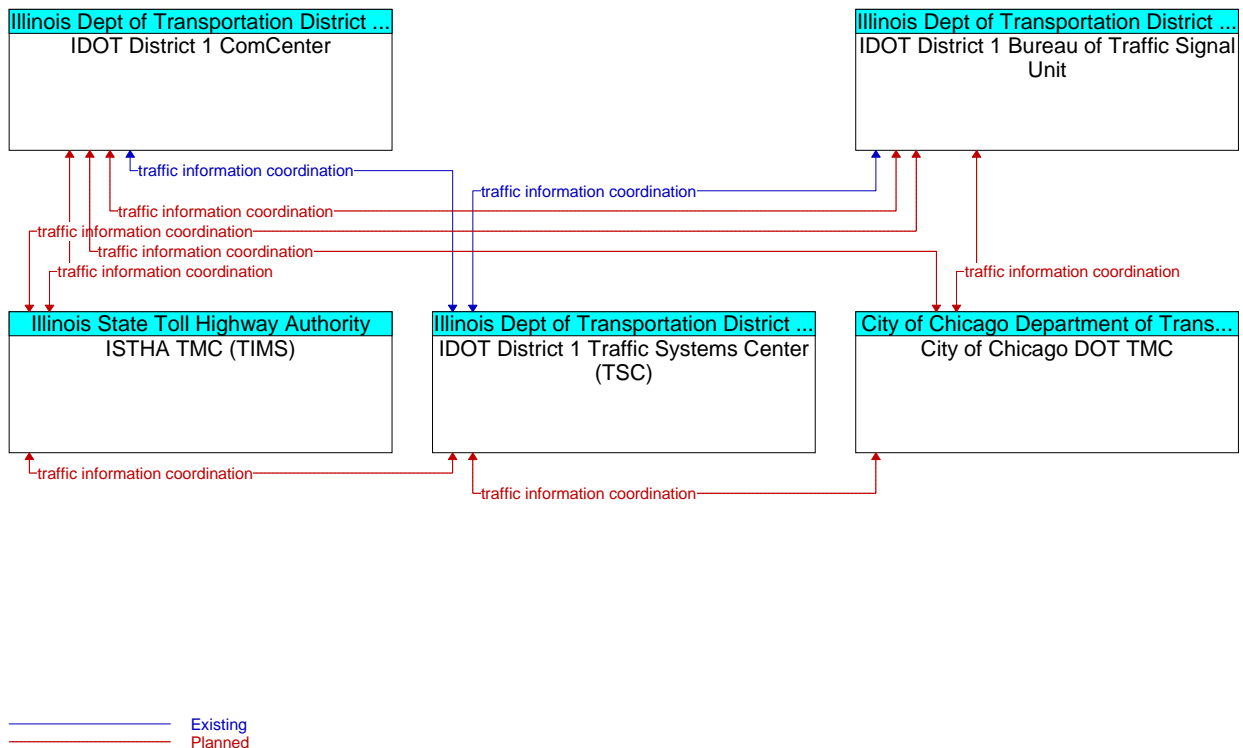


Figure A3-52: CCTV Surveillance Sharing (ID 48)

**A3-8.6 IDOT CCTV Systems, Expressway (ID 49)**

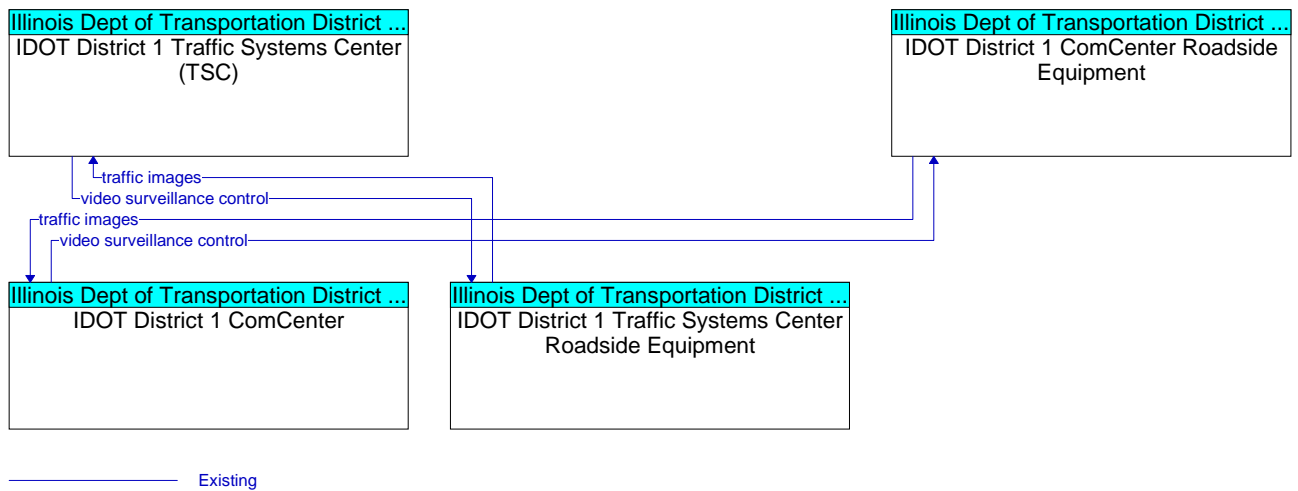
This project involves augmenting the CCTV systems IDOT has deployed along the expressways. The elements involved in this project are:

- IDOT District 1 ComCenter
- IDOT District 1 ComCenter Roadside Equipment
- IDOT District 1 Traffic Systems Center (TSC)
- IDOT District 1 Traffic Systems Center Roadside Equipment

The market packages provided by this project are:

- Network Surveillance (ATMS01) and,
- Traffic Incident Management (ATMS08).

The interfaces and information flows from the Regional ITS Architecture that are covered by this project are shown in Figure A3-53.

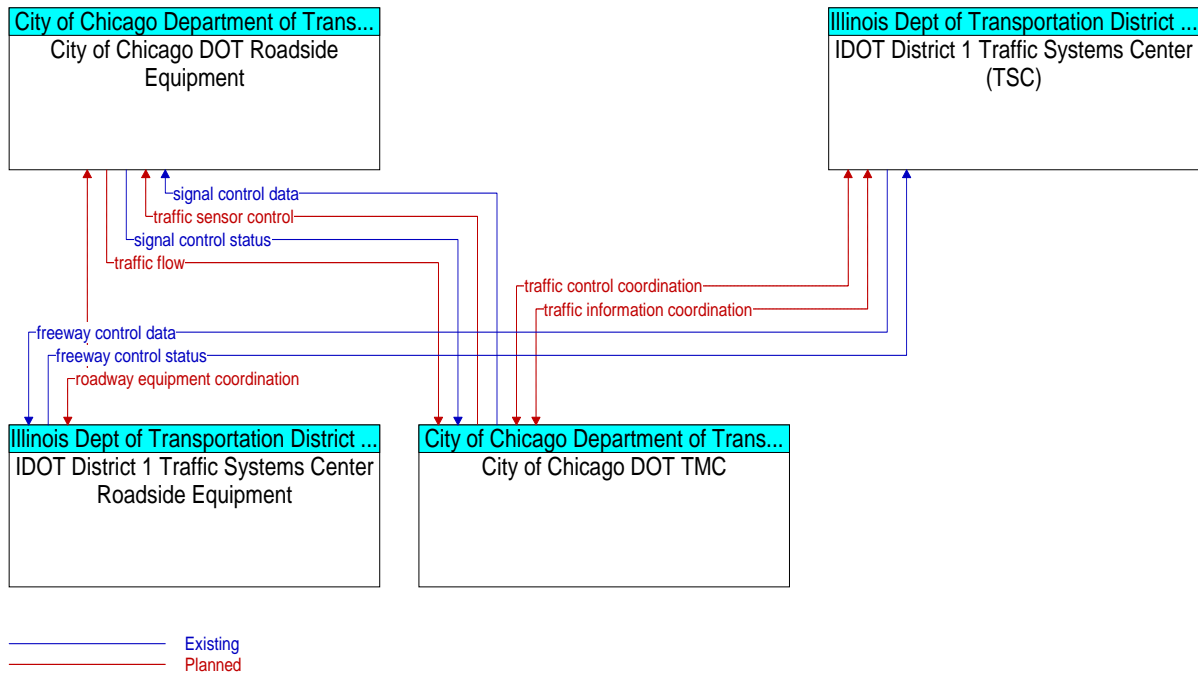


**Figure A3-53: IDOT CCTV Systems Expressway (ID 49)**

**A3-8.7 Integrated Expressway/ Arterial Corridors (ID 50)**

This project considers coordination between expressway and arterial systems. Plans for a Pilot Project would involve a tie-in of Eisenhower Expressway to Chicago DOT signals by having ramp queue detectors, both for on-ramps and off-ramps. Ramp terminal signal control would then be modified to either hold entry to I-290 (on-ramp congestion) or clear the off-ramp (spillback onto I-290). The implementation might link CDOT signals with IDOT Traffic Systems Center, or whether have local links to ramp meters only. The project involves the following elements from the Regional ITS Architecture:

- IDOT District 1 TSC
- IDOT District 1 Traffic Systems Center Roadside Equipment (representing ramp meters operated by IDOT)
- City of Chicago DOT TMC
- City of Chicago DOT Roadside Equipment (representing traffic signal operated by CDOT)



**Figure A3-54: Integrated Expressway/ Arterial Corridors (ID 50)**

The market package provided by this project is Regional Traffic Control (ATMS07). The interfaces and information flows from the Regional ITS Architecture that are covered by this project are shown in Figure A3-54. One interface, the possible one between CDOT Roadside Equipment and IDOT Roadside Equipment is not in the current Regional ITS Architecture and would need to be added if this connectivity becomes a part of the project.

**A3-8.8 Expressway Traffic Diversion Demo (ID 51)**

This is a demo project to divert traffic from expressways due to incident or congestion on the expressway. The project involves installing DMS signs on arterials to direct traffic. It would also involve coordination between IDOT centers for placing appropriate information on the signs.

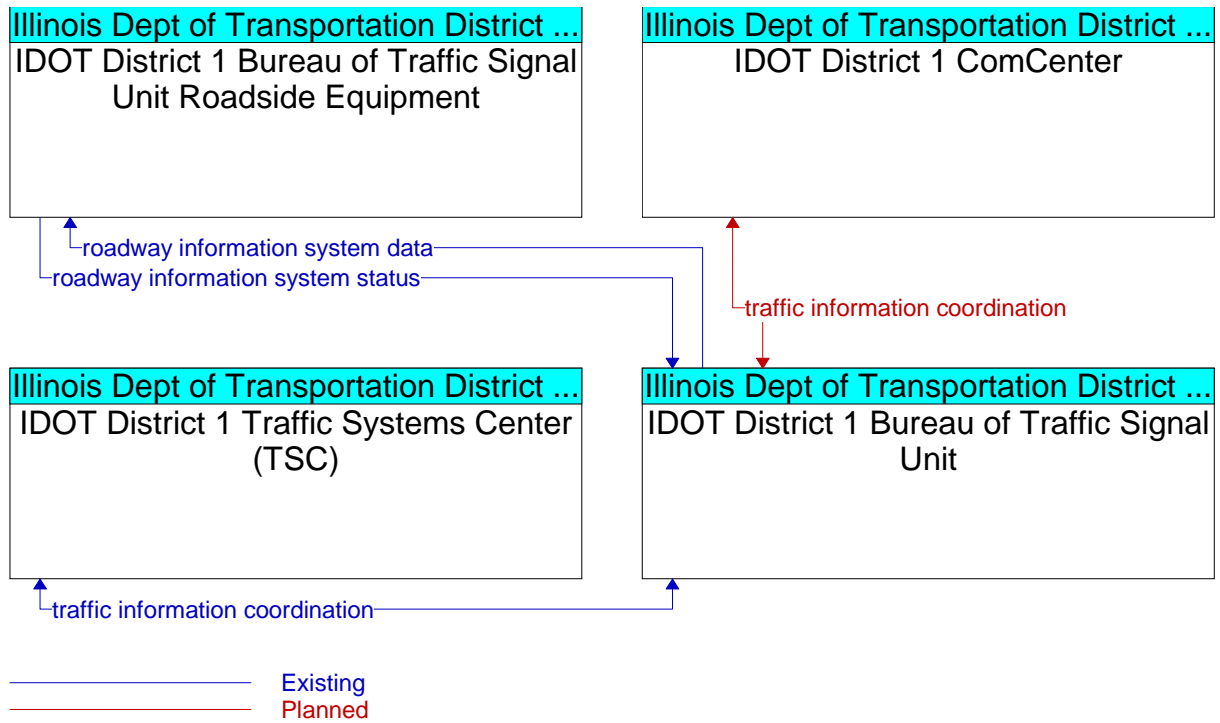
The project will address following Market Packages:

- Traffic Information Dissemination (ATMS06) and
- Traffic Incident Management (ATMS08).

The elements from the Regional ITS Architecture involved in the project are:

- IDOT District 1 ComCenter
- IDOT District 1 TSC
- IDOT District 1 Bureau of Traffic Signal Unit
- IDOT District 1 Bureau of Traffic Signal Unit Roadside Equipment

The interfaces and information flows that cover this project are shown in Figure A3-55.



**Figure A3-55: Expressway Traffic Diversion Demo (ID 51)**

**A3-8.9 Automatic Crash Notification (ACN) to PSAPs (ID 52)**

This project provides automatic crash notification to PSAPs throughout the region. This project provides the following Market Package:

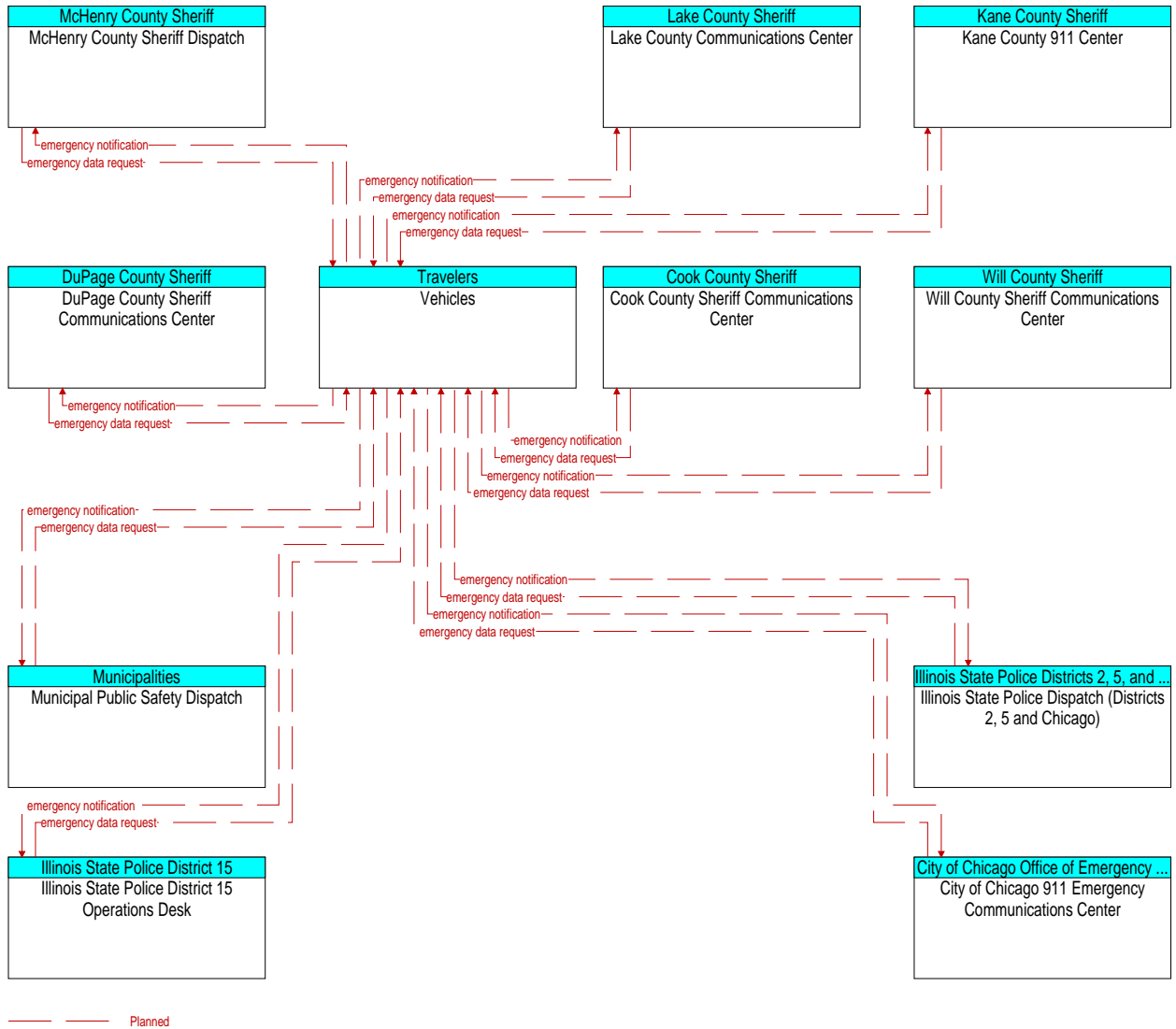
- Mayday Support (EM03)

The project involves the following elements from the Regional ITS Architecture:

- City of Chicago 911 Emergency Communications Center
- Cook County Sheriff Communications Center
- DuPage County Sheriff Communications Center
- Illinois State Police Dispatch (Districts 2, 5 and Chicago)
- Illinois State Police District 15 Operations Desk
- Kane County 911 Center
- Lake County Communications Center
- McHenry County Sheriff Dispatch
- Municipal Public Safety Dispatch
- Will County Sheriff Communications Center
- Vehicles

The interfaces and information flows that cover this project are shown in Figure A3-56. None of these interfaces exist in the current Regional ITS Architecture and would need to be added to it.





**FigureA3-56: Automatic Crash Notification (ACN) to PSAPs (ID 52)**

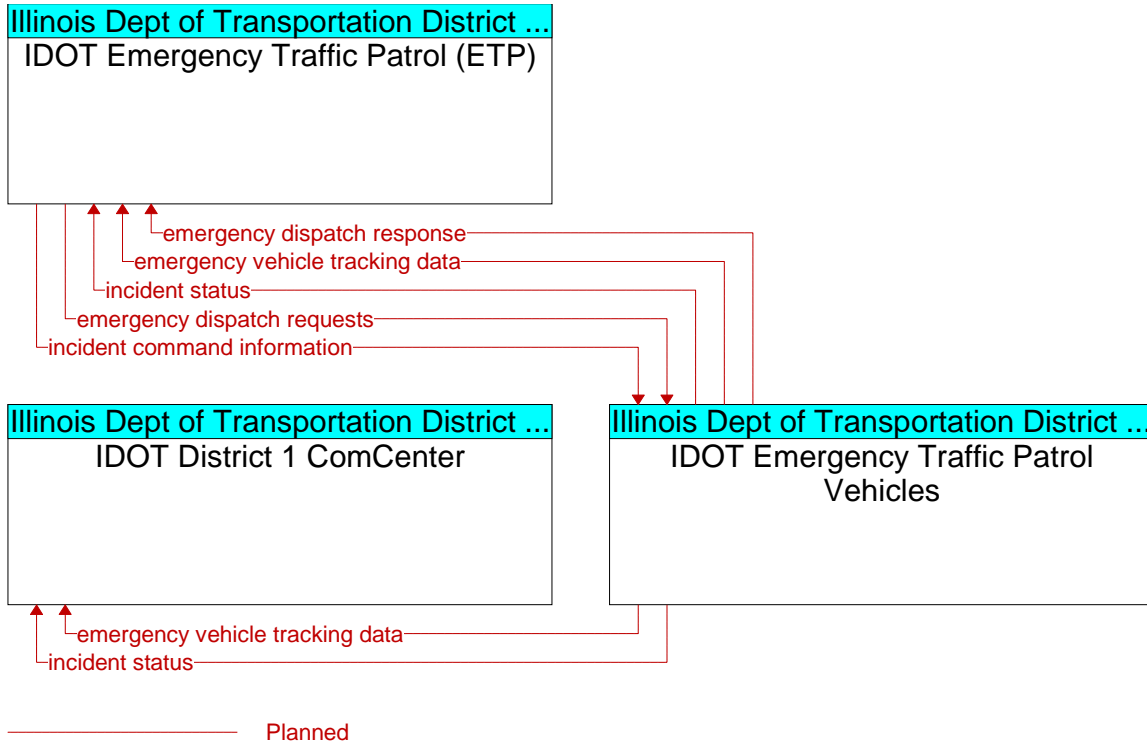
**A3-8.10 Regionwide Emergency Traffic Operations Systems (ETOS) Upgrade (ID 53)**

The project will be the follow-on to a pilot project that involved 6 ETP equipped vehicles (5 maintenance vehicles & 1 command vehicle) which has been recently completed. Purpose of the initial project was to get incident info to the Gateway. The follow-on project will likely involve both AVL and simplified MDT (keypad) to input basic incident info at the vehicle and send it to the Com Center and ETP dispatch. The Market Package provided by this project is Roadway Service Patrol (EM04). The elements from the Regional ITS Architecture involved in the project are:

- IDOT Emergency Traffic Patrol Vehicles
- IDOT Emergency Traffic Patrol (ETP)

- IDOT District 1 ComCenter

The interfaces and information flows that cover this project are shown in Figure A3-57. The interface between the ETP Vehicles and the IDOT District 1 ComCenter does not exist in the current Regional ITS Architecture and would need to be added to it.



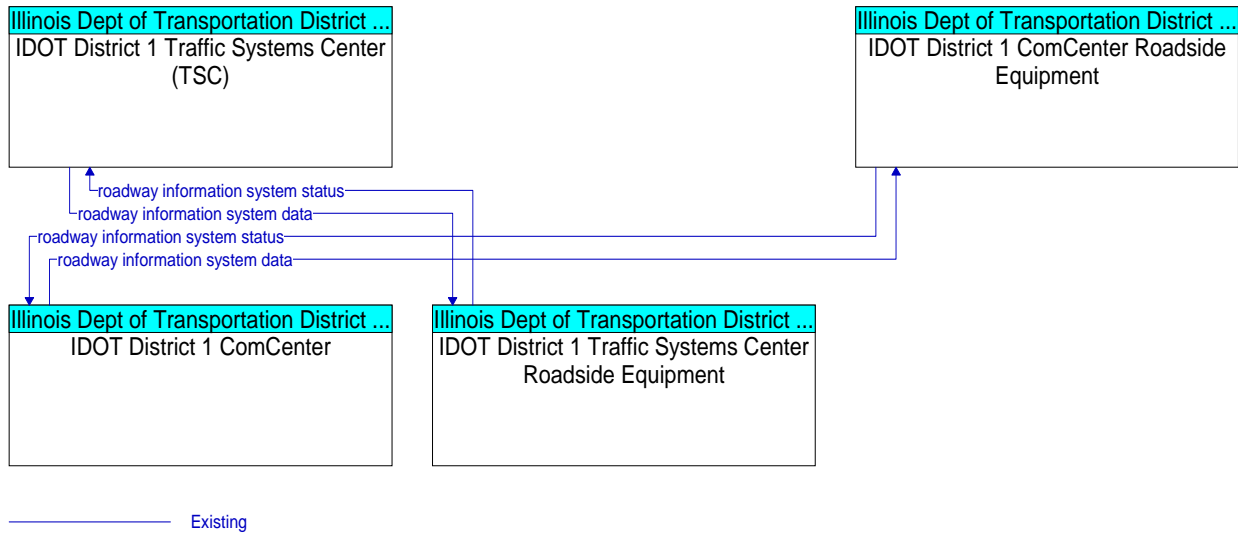
**Figure A3-57: Regionwide Emergency Traffic Operations Systems (ETOS) Upgrade (ID 53)**

**A3-8.11 IDOT District 1 DMS Deployment (ID 54)**

This project involves expansion of the existing DMS network along IDOT expressways. Current project is installing 28 inbound DMS on expressways by 12/04. Future project will install ~25 outbound signs on IDOT expressways primarily. Message generation and posting could be statewide. The project will address the Market Package Traffic Information Dissemination (ATMS06). The elements from the Regional ITS Architecture involved in the project are:

- IDOT District 1 ComCenter
- IDOT District 1 ComCenter Roadside Equipment (represents DMS devices operated by IDOT)
- IDOT District 1 TSC
- IDOT District 1 Traffic Systems Center Roadside Equipment

The interfaces and information flows that cover this project are shown in Figure A3-58.



**Figure A3-58: IDOT District 1 DMS Deployment (ID 54)**

**A3-8.12 GATEWAY Traveler Information System, Phase II (ID 55)**

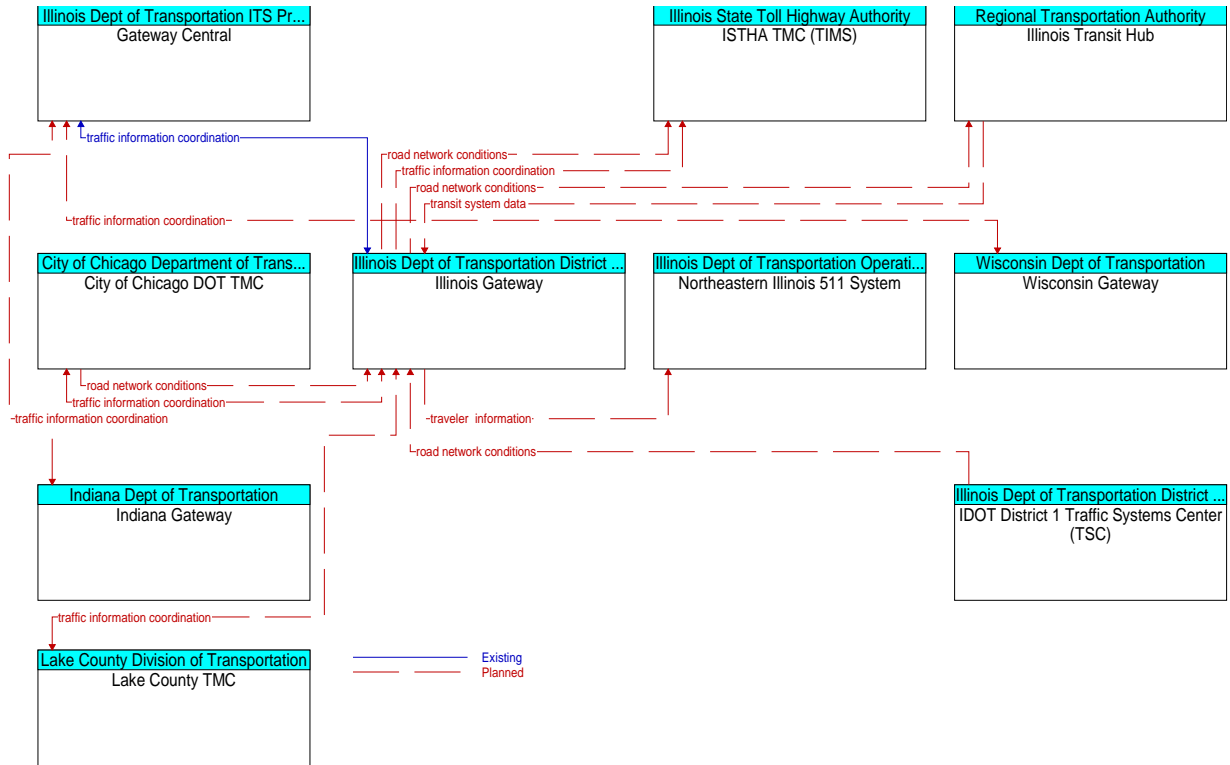
This project will expand the Gateway capabilities by adding new interfaces to traffic management and emergency management elements. It will also include connection to the statewide 511 system. The Market Packages covered by this project include

- Traffic Incident Management (ATMS08)
- Broadcast Traveler Information (ATIS1)

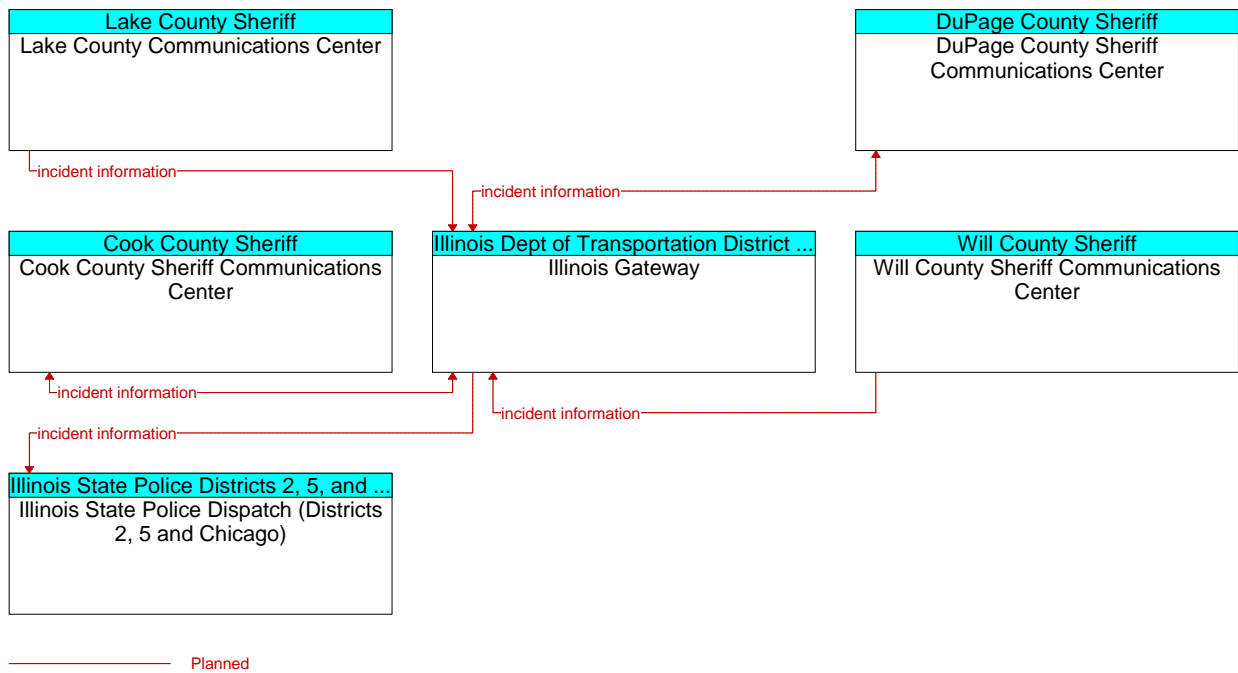
The elements from the Regional ITS Architecture covered by this project are:

- Illinois Gateway
- Gateway Central
- Gateway Website
- Illinois Transit Hub
- Northeastern Illinois 511 System
- Other Traffic Management elements (see figure below)
- Other emergency management elements (see figure below)

The interfaces and information flows from the Regional ITS Architecture that are covered by this project are shown in Figure A3-59 and Figure A3-60.



**Figure A3-59: GATEWAY Traveler Information System, Phase II (ID 55)- traffic management, transit and 511 interfaces**



**Figure A3-60: GATEWAY Traveler Information System, Phase II (ID 55) - emergency management interfaces**

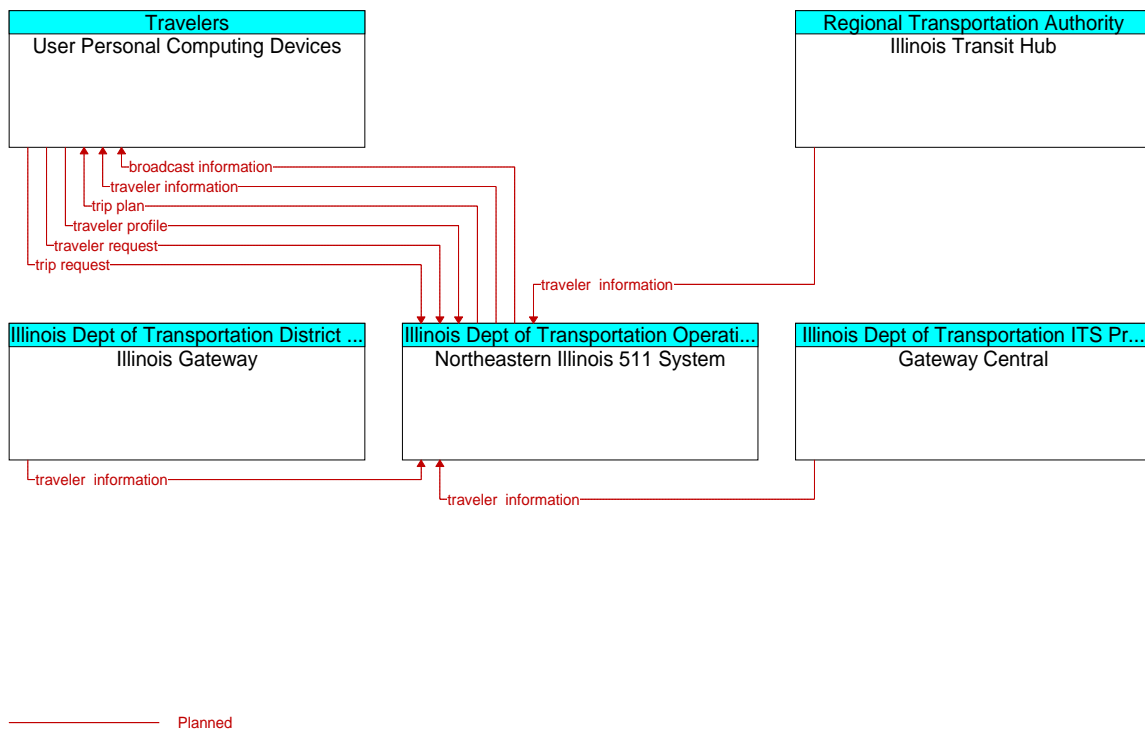
**A3-8.13 Statewide 511 Service (ID 56)**

This project provides implementation of a statewide integrated traveler information system using a common three digit number 511. The project would include RTA and Gateway links. The Market Package provided by this project is Interactive Traveler Information (ATIS2).

The elements from the Regional ITS Architecture covered by this project are:

- Illinois Gateway
- Gateway Central
- Illinois Transit Hub
- Northeastern Illinois 511 System

The interfaces and information flows from the Regional ITS Architecture that are covered by this project are shown in Figure A3-61. The interface between the NE Illinois 511 System and the User Personal Computing Devices is not in the current Regional ITS Architecture and would need to be added.



**Figure A3-61: Statewide 511 Service (ID 56)**

### **A3-8.14 IDOT - HAR System Coordination (ID 57)**

This project would provide coordination of Highway Advisory Radio (HAR) operations between IDOT and other traffic elements in the region, e.g., IDOT and counties, or IDOT and O'Hare/Midway HAR systems.. It may include full two-way communication and automated sharing of event information as well as text to speech conversion. Plan does not call for direct sharing of control of the HAR systems by the other agency. The project will address portions of the Market Packages Traffic Information Dissemination (ATMS06) and Traffic Incident Management (ATMS08). The elements from the Regional ITS Architecture involved in the project are:

- IDOT District 1 ComCenter
- IDOT District 1 ComCenter Roadside Equipment (represents HAR devices operated by IDOT)
- City of Chicago DOT TMC
- Cook County TMC
- IDOT District 1 TSC
- ISTHA TMC (TIMS)
- Kane County TMC
- Lake County TMC
- McHenry County TMC
- Satellite TMC O'Hare Airport
- Satellite TMC Midway Airport
- Will County TMC

The interfaces and information flows that cover this project are shown in Figure A3-62. All of these interfaces are in the current Regional ITS Architecture except:

- ComCenter to or from Satellite TMC Midway Airport
- Lake County TMC to ComCenter (just this direction)
- Kane County TMC to ComCenter (just this direction)



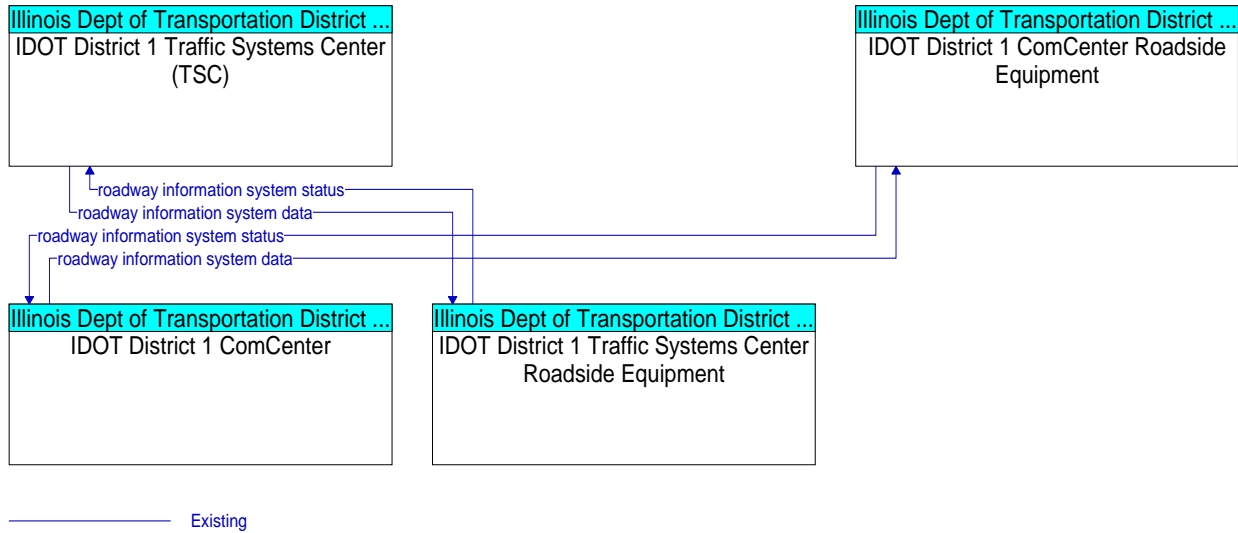
**Figure A3-62: HAR System Coordination (ID 57)**

**A3-8.15 IDOT HAR System Enhancement (ID 58)**

The project includes upgrades and enhancements to existing HAR systems including more transmitters, potentially including common HAR frequency & synchronized broadcasts in District 1. The project will address the Market Package Traffic Information Dissemination (ATMS06). The elements from the Regional ITS Architecture involved in the project are:

- IDOT District 1 ComCenter
- IDOT District 1 ComCenter Roadside Equipment (represents HAR devices operated by IDOT)
- IDOT District 1 TSC
- IDOT District 1 Traffic Systems Center Roadside Equipment

The interfaces and information flows that cover this project are shown in Figure A3-63. The diagram is identical to that for project ID 44, since from an architecture viewpoint DMS and HAR are similar devices.

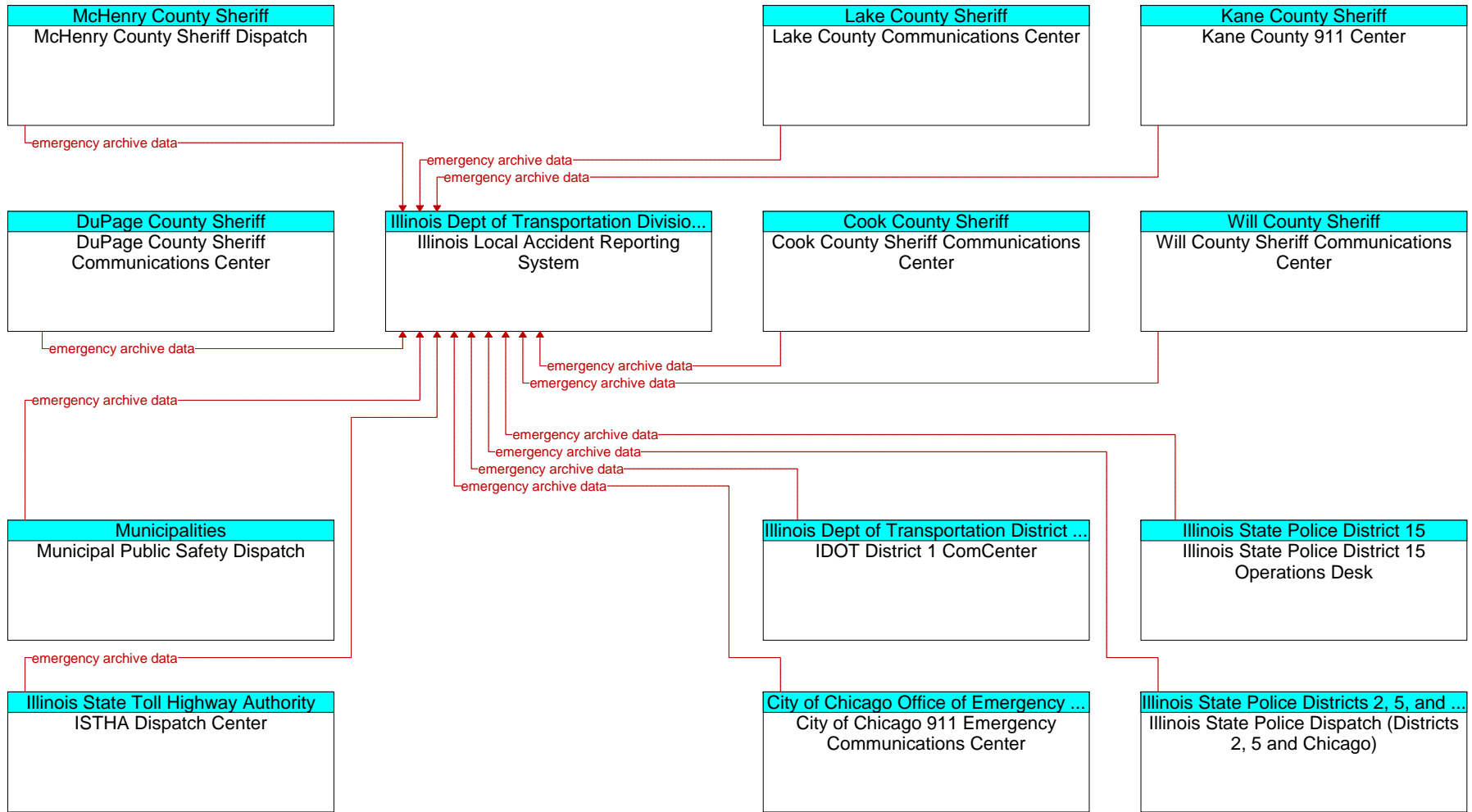


**Figure A3-63: IDOT HAR System Enhancement (ID 58)**

**A3-8.16 Accident Database and Reporting System (ID 59)**

This project involves development of an accident or crash database for use by law enforcement and other incident response agencies to aid in incident response. The Market Package covered by this project is ITS Data Mart (AD1). The Regional ITS Architecture does not cover this project explicitly, but does have the following element that relates to the functionality of the project: Illinois Local Accident Reporting System. So a representation of this project could be the interfaces from public safety elements in the architecture to this archive. The interfaces and information flows from the Regional ITS Architecture that are covered by this project are shown in Figure A3-64.





Planned

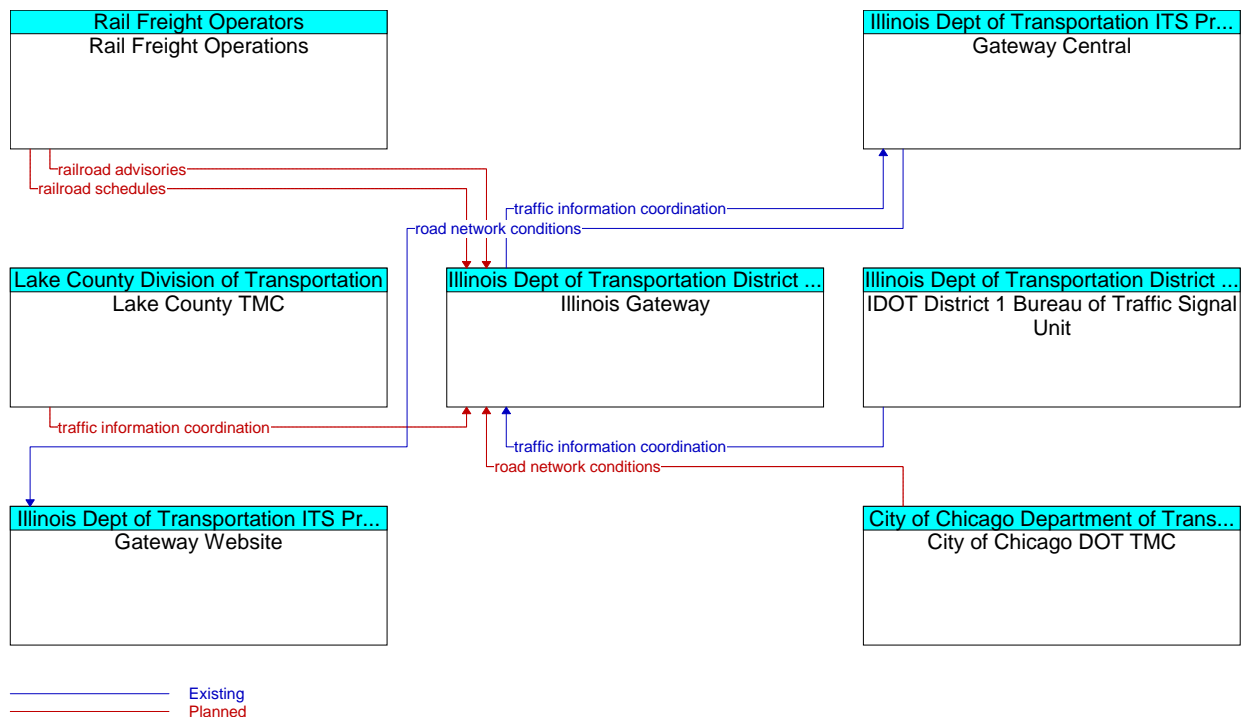
Figure A3-64: Accident Database and Reporting System (ID 59)

**A3-8.17 Railroad Grade Crossing Delay - Traveler Information System (ID 64)**

This project would develop a Traveler Information System to provide travelers with information regarding delays due to trains. The elements from the Regional ITS Architecture covered by this project are:

- GCM Gateway Central
- Gateway Website
- Illinois Gateway
- Traffic Management elements from the region (see figure below).

The market package provided by this project is Broadcast Traveler Information (ATIS1). The interfaces and information flows from the Regional ITS Architecture that are covered by this project are shown in Figure A3-65.



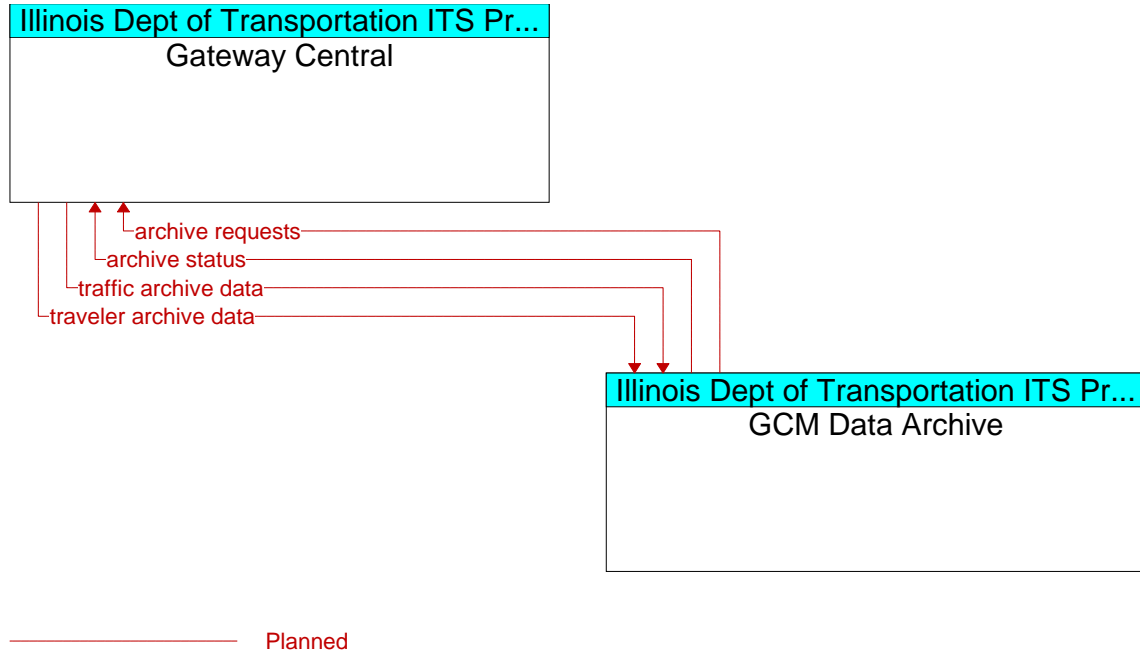
**Figure A3-65: Railroad Grade Crossing Delay - Traveler Information System (ID 64)**

**A3-8.18 ITS Planning Database (ID 65)**

This project defines a GIS-based database of corridor ITS assets. The Market Package covered by this project is ITS Data Mart (AD1). The elements from the Regional ITS Architecture covered by this project are:

- GCM Data Archive
- GCM Gateway Central

The interfaces and information flows from the Regional ITS Architecture that are covered by this project are shown in Figure A3-66. This interface represents what is in the Regional ITS Architecture and would likely need to be expanded to give a more complete description of the project.



**Figure A3-66: ITS Planning Database (ID 65)**

**A3-8.19 Traveler Information Archive (ID 66)**

This project will develop an electronic archive for the travel information collected by GCM corridor. The Market Package covered by this project is ITS Data Mart (AD1). The elements from the Regional ITS Architecture covered by this project are:

- GCM Data Archive
- GCM Gateway Central

The interfaces and information flows from the Regional ITS Architecture that are covered by this project are the same as for the earlier project, ITS Planning Database, shown in Figure A3-66. This interface represents what is in the Regional ITS Architecture and would likely need to be expanded to give a more complete description of the project

**A3-8.20 IDOT Projects Not Mapped to Regional ITS Architecture**

Several IDOT projects do not easily map to the Regional ITS Architecture either because they do not relate directly to elements and interfaces of the architecture or because they represent services that are not included in the architecture. The projects are listed below along with the reason for not assigning a mapping:

- Regional Communications Backbone (ID 40)- this project relates to the communications infrastructure that supports connectivity in the architecture, but does not encompass specific connections between elements of the architecture.

- SRA Traffic Signal Battery Back-Up (ID 45)- this project is an upgrade to IDOT signal controller equipment to provide LED Back-Up of SRA Traffic Signals. It does not impact any interfaces (just the single element IDOT District 1 Bureau of Traffic Signal Unit Roadside Equipment).
- Surveillance of Critical Bridge Infrastructure (ID 46)- this project includes installation of lighting, fencing and CCTV on 16 bridges in northeast Illinois. The Regional ITS Architecture does not contain this service (Transportation Infrastructure Protection), which was added the National ITS Architecture in Version 5.
- NE Illinois Regional ITS Architecture Update (ID 47)- this project will update the 2002 Regional ITS Architecture to reflect changes in national program outlook and regional perspective on ITS. As such the project is not the deployment of ITS systems, but the description of those systems in a regional framework.
- ITS Applications for Work Zones (ID 60) This project will study current "best practices" in work zone management and provide a field demonstration of the technologies. The Market packages covered by this project are Workzone Management and Workzone Safety Monitoring. The particular focus would be on the Maintenance Management Center to field devices. While the Regional ITS Architecture covers interfaces between maintenance organizations, at least for IDOT elements it does not cover the field device interfaces that would be the subject of this effort. The details of these interfaces as defined by this project would need to be added to the Regional ITS Architecture.
- IDL/XML Schema for Centers Communication (ID 61)- this project will develop Interface Definition Language (IDL) and Extensible Markup Language (XML) for connecting local/regional TMCs to Gateway. It will cover what arterial performance info to send, how to display, whether or not control to be shared. This project primarily relates to developing a standardized communications protocol for center to center. As such it does not deal directly with elements and interfaces, but is rather an enabling task to make a variety of center to center interfaces.
- Mobile Technologies to Measure Travel Times Using Probe Vehicles (ID 62) This project will study a cost-effective approach for collecting travel time data and other traffic conditions using non-traditional detection methods. Potentially a public-private partnership demo using cell phones (e.g., with AirSage or ITIS Holdings, private partners). This type of connectivity (using cell phones for probes) isn't currently covered by architecture but could be added if the project moves into an implementation phase.
- Travel Time Prediction Project (ID 63)- this is a demo project to use archived info and simulation to predict near-term performance. It is primarily a feasibility study to see if the methodology is effective. As such it does not relate to specific elements and interfaces of the Regional ITS Architecture. If successful, then the approach could be applied to specific systems that are part of the Regional ITS Architecture.

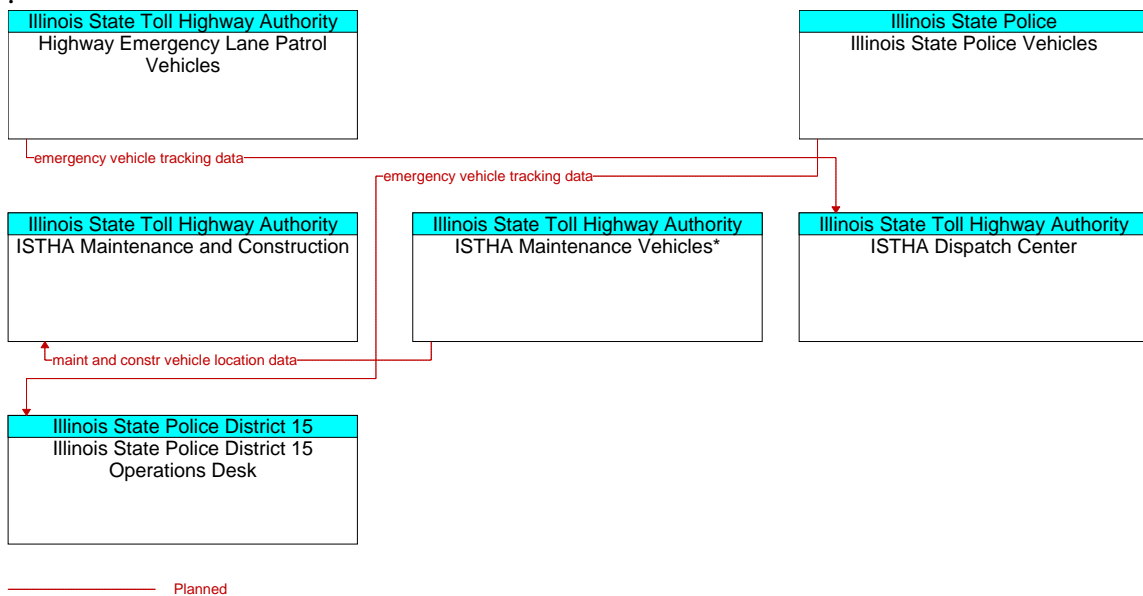
### A3-9 ISTHA Projects

#### A3-9.1 ISTHA fleet AVL (ID 67)

This project will expand implement automatic vehicle location (AVL) using a technology such as GPS on ISTHA maintenance vehicles, HELP vehicles, and Illinois State Police vehicles. The Market Packages covered by this project are Maintenance AND Construction Vehicle and Equipment Tracking (MC01) and Emergency Routing (EM02). The elements from the Regional ITS Architecture covered by this project are:

- ISTHA Dispatch Center
- Highway Emergency Lane Patrol Vehicles
- Illinois State Police District 15 Operations Desk
- Illinois State Police Vehicles
- ISTHA Maintenance and Construction
- ISTHA Maintenance Vehicles\* (this element is not in the current Regional ITS Architecture and will have to be added).

The interfaces and information flows from the Regional ITS Architecture that are covered by this project are shown in Figure A3-67.



**Figure A3-67: ISTHA Fleet AVL (ID 67)**

### A3-9.2 ISTHA Kiosks (ID 68)

This project will deploy kiosks at various locations along the Tollway (e.g. traveler rest stops) to access traveler information for NE Illinois. The Market Packages covered by this project are Broadcast Traveler Information (ATIS1) and Interactive Traveler Information (ATIS2). The elements from the Regional ITS Architecture covered by this project are:

- ISTHA TMC (TIMS)
- ISTHA Kiosks

The interfaces and information flows from the Regional ITS Architecture that are covered by this project are shown in Figure A3-68.

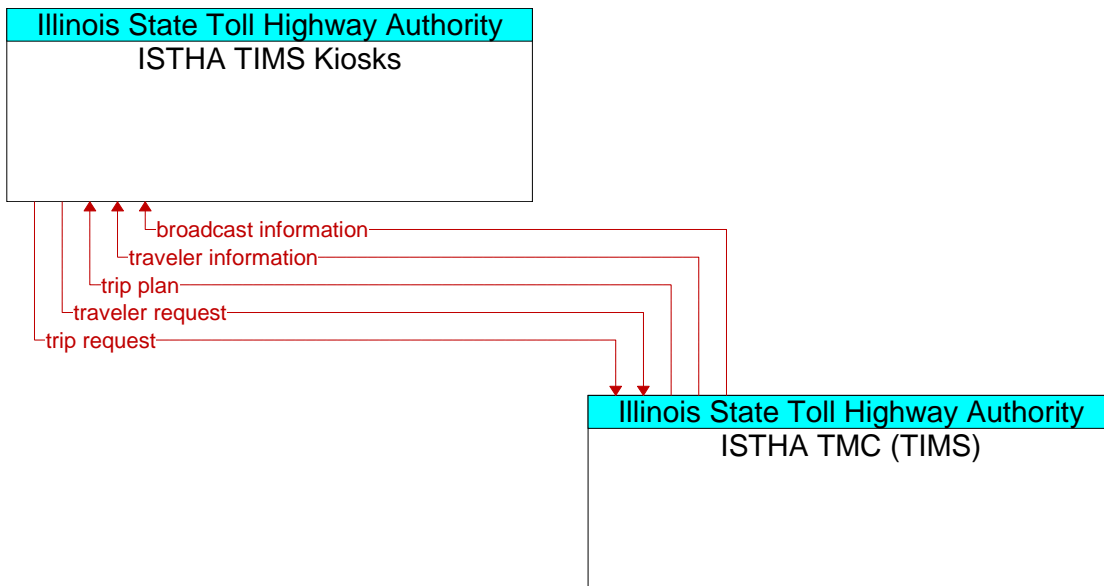


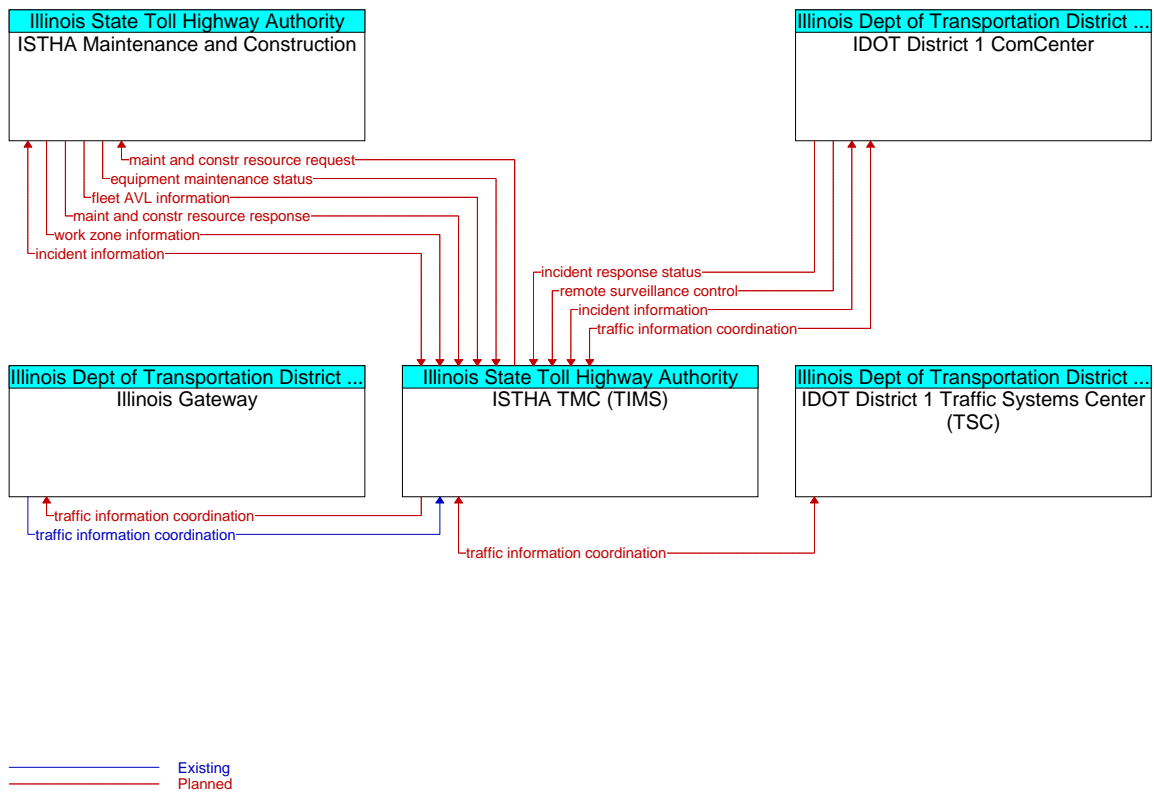
Figure A3-68: ISTHA Kiosks (ID 68)

### A3-9.3 ISTHA TIMS Enhancement (ID 69)

This project will expand the software capabilities of the TIMS, including enhanced connectivity to the Gateway and other centers in the region. The Market Packages covered by this project are Regional Traffic Control (ATMS07) and Traffic Incident Management (ATMS08). The elements from the Regional ITS Architecture covered by this project are:

- ISTHA TMC (TIMS)
- ISTHA Maintenance and Construction
- Other traffic management elements as shown in the figure.

The interfaces and information flows from the Regional ITS Architecture that are covered by this project are shown in Figure A3-69.



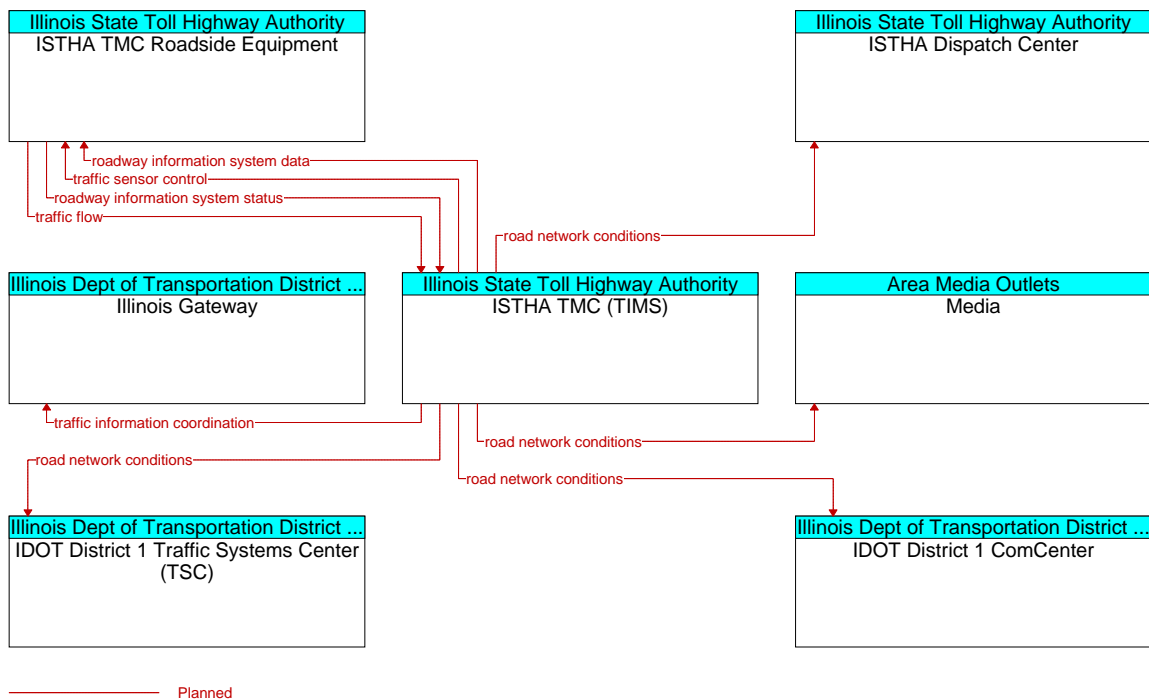
**Figure A3-69: ISTHA TIMS Enhancement (ID 69)**

### A3-9.4 ISTHA Portable Queue Detection Systems (ID 70)

This project will expand the "Hot spot" queue detection on mainline and warn motorists of problems via DMS. The TIMS might also provide information about the queues to the Gateway, the media, and other IDOT elements. The Market Packages covered by this project are Network Surveillance (ATMS01), Traffic Information Dissemination (ATMS06) and Traffic Incident Management (ATMS08). The elements from the Regional ITS Architecture covered by this project are:

- ISTHA TMC (TIMS)
- ISTHA TMC Roadside Equipment
- Other traffic elements per the figure below

The interfaces and information flows from the Regional ITS Architecture that are covered by this project are shown in Figure A3-70.



**Figure A3-70: ISTHA Portable Queue Detection Systems (ID 70)**



### A3-9.5 ISTHA - CCTV Coverage (ID 71)

This project will expand CCTV coverage on the Tollway and provide the images from the TIMS to the Illinois State Police Dispatch, ISTHA Dispatch, and IDOT TSC. The Market Package covered by this project is Traffic Incident Management (ATMS08). The elements from the Regional ITS Architecture covered by this project are:

- ISTHA TMC (TIMS)
- ISTHA TMC Roadside Equipment
- Illinois State Police District 15 Operations Desk
- ISTHA Dispatch
- IDOT TSC

The interfaces and information flows from the Regional ITS Architecture that are covered by this project are shown in Figure A3-71. The interfaces from ISTHA TMC (TIMS) with the flow “video images” are not in the current Regional ITS Architecture and will need to be added.

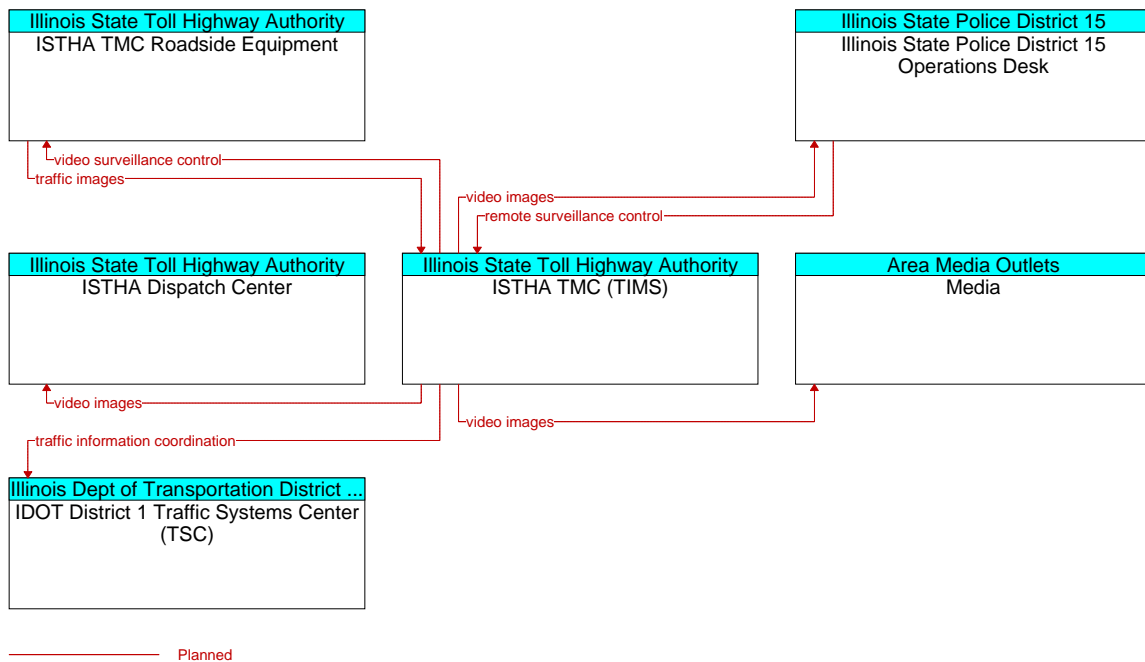


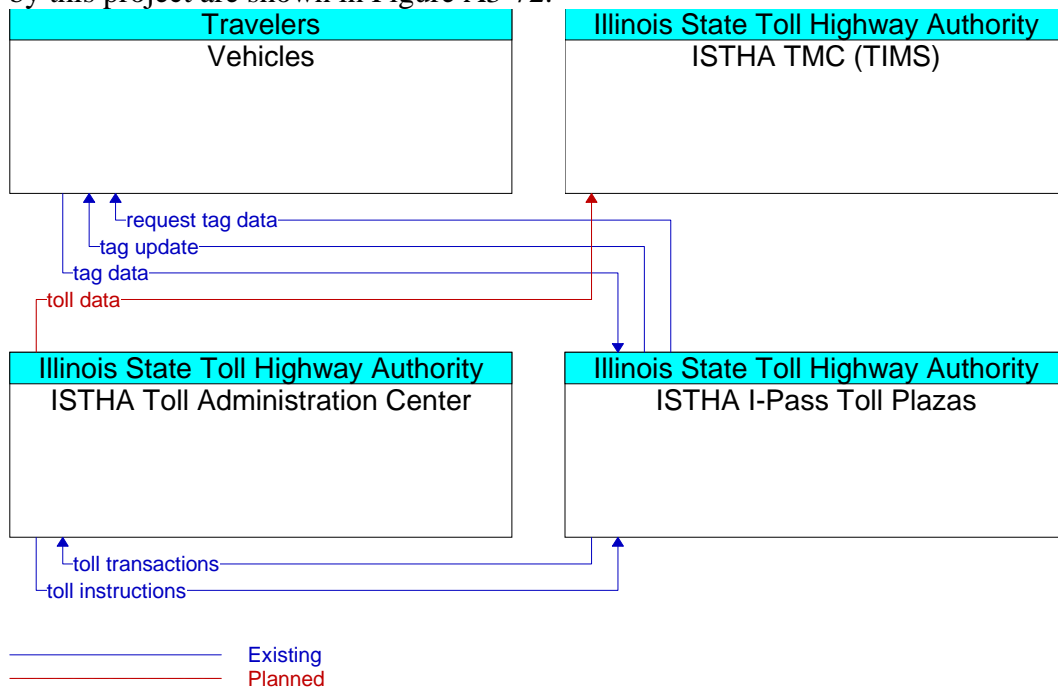
Figure A3-71: ISTHA CCTV Coverage (ID 71)

**A3-9.6 ISTHA Systemwide Open Road Tolling (ORT) (ID 72)**

This project covers upgrades to the Tollway Toll Plazas for capabilities such as mixed use truck/car lane enhancements at all toll booths and use of "open-road" tolling (no stopping required). The Market package covered by this project is Electronic Toll Collection (ATMS10). The elements from the Regional ITS Architecture covered by this project are:

- ISTHA I-Pass Toll Plazas
- ISTHA Toll Administration Center
- ISTHA TMC (TIMS)

The interfaces and information flows from the Regional ITS Architecture that are covered by this project are shown in Figure A3-72.



**Figure A3-72: ISTHA Systemwide Open Road Tolling (ORT) (ID 72)**

### A3-9.7 ISTHA DMS Deployment (73)

This project will deploy Dynamic Message Signs along the Tollway. The Market Package covered by this project is Traffic Information Dissemination (ATMS06). The elements from the Regional ITS Architecture covered by this project are:

- ISTHA TMC (TIMS)
- ISTHA TMC Roadside Equipment
- Other elements to inform of messages put up on DMS as shown below

The interfaces and information flows from the Regional Architecture that are covered by this project are shown in Figure A3-73. The interface from TIMS to the Media is not in the current Regional ITS Architecture and will need to be added.

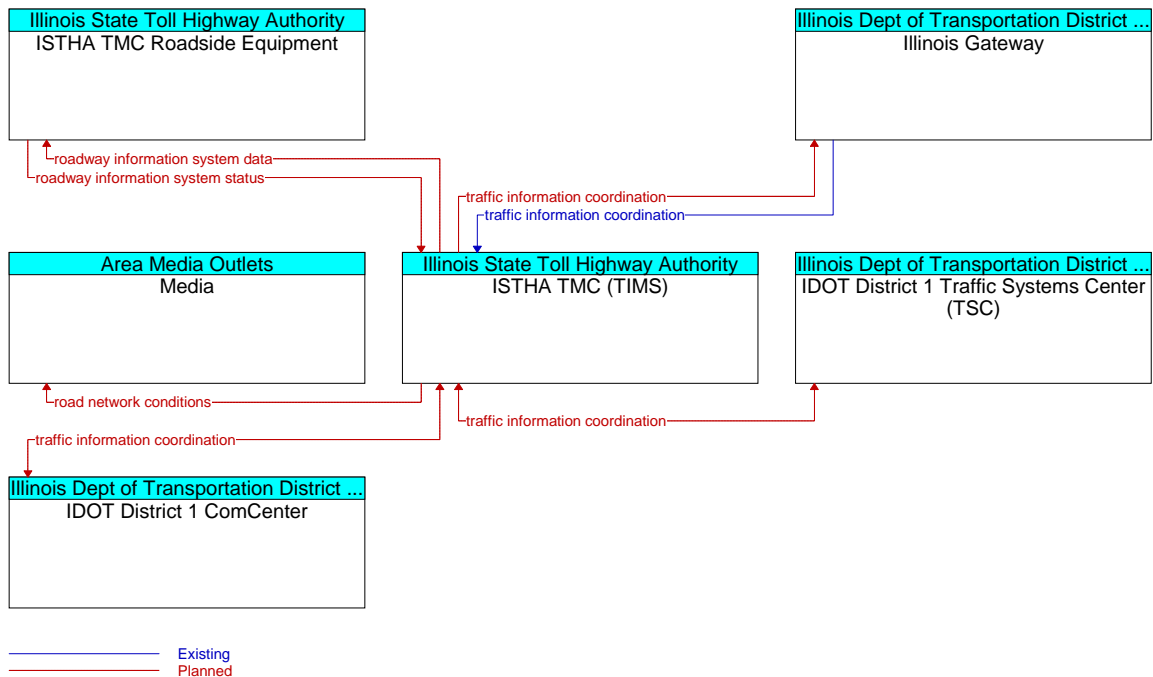


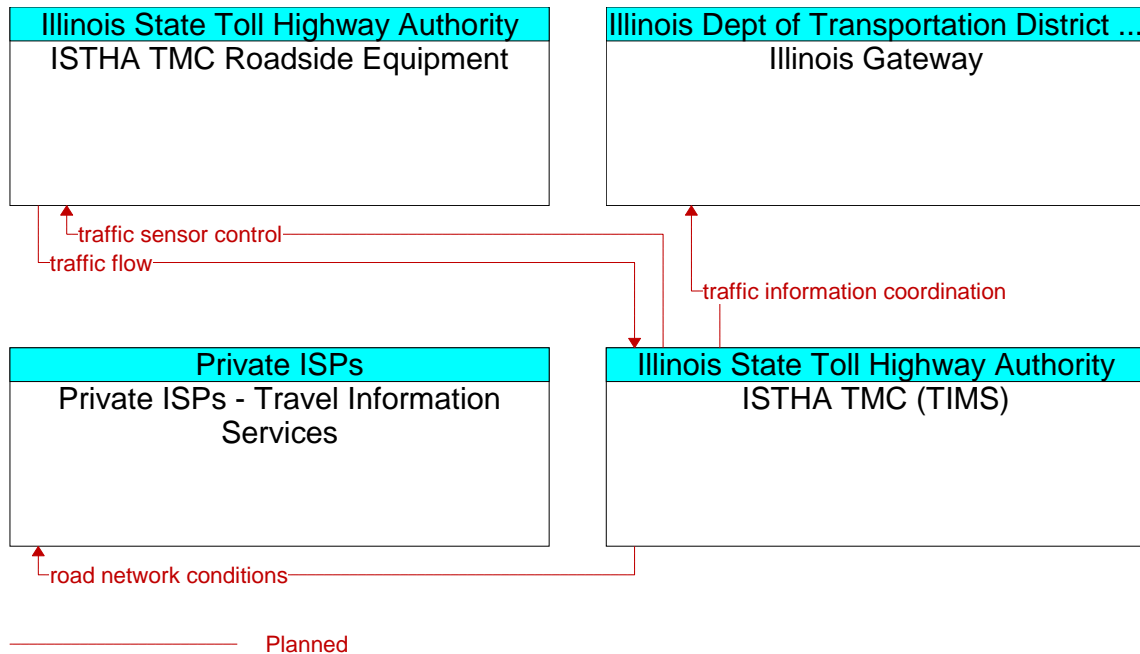
Figure A3-73: ISTHA DMS Deployment (ID 73)

**A3-9.8 Expansion of Public-Private Partnership to Monitor Traffic (ID 74)**

This project will include the addition of ~100 non-intrusive detector stations (~105 existing) to monitor speed/travel time and incidents on the Tollway. The Market Package covered by this project is Network Surveillance (ATMS01). The elements from the Regional ITS Architecture covered by this project are:

- ISTHA TMC (TIMS)
- ISTHA TMC Roadside Equipment

The interfaces and information flows from the Regional ITS Architecture that are covered by this project are shown in Figure A3-74. The interface from the ISTHA TMC (TIMS) to the Private ISPs, if applicable to this project, is not in the current Regional ITS Architecture and would need to be added.



**Figure A3-74: ISTHA DMS Deployment (ID 74)**

## **A3-10 RTA Projects**

### **A3-10.1 Transit Hub: APTS (ID 75)**

This project involves design and development of the Illinois Transit Hub to better manage transit operations. This project heading is used to cover three separate efforts, whose mapping to the Regional ITS Architecture is described below. The three efforts are:

- Deployment of the Illinois Transit Hub itself
- Transfer Connection Protection-- This effort involves real-time monitoring of CTA, PACE, and Metra operations to protect against missed transfers.
- Regionwide Automatic Fare Collection System—This effort involves planning, design, and deployment of a regional transit fare collection system.

The latter two efforts represent uses of the Transit Hub to share information between transit centers in the region.

The Transit Hub will support the following Market Packages:

- Transit Interagency Coordination (part of Multimodal Coordination) (APTS7)
- Transit Passenger and Fare Management (APTS4)
- Parking Facility Management (ATMS16)
- Transit Traveler Information (APTS8)
- Transit Security (APTS5)
- Archive Data Management (AD1)

The Illinois Transit Hub is the element name in the Regional ITS Architecture. In the architecture interfaces from the hub to the following elements are defined:

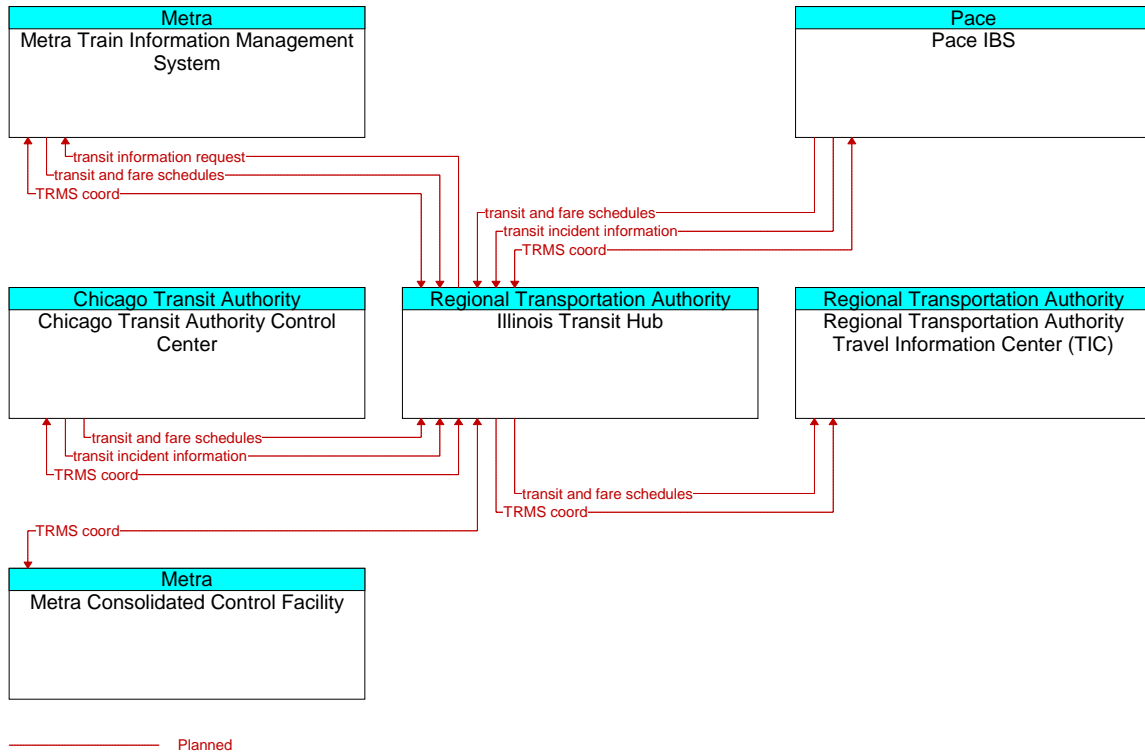
- CATS Dynamic Ridesharing
- Chicago Airports
- Chicago Transit Authority BusInfo Signs
- Chicago Transit Authority Active Transit Station Signs
- Chicago Transit Authority ATSS System
- Chicago Transit Authority BusInfo System
- Chicago Transit Authority Control Center (this element includes the CTA Hub)
- Chicago Transit Authority Paratransit Dispatch
- Chicago Transit Authority Parking Management Guidance System
- DuPage Centralized Paratransit Dispatch
- Illinois Gateway
- Independent School District Dispatch
- Media
- Metra Passenger Information Display System
- Metra Consolidated Control Facility
- Metra Parking Management Guidance System
- Metra Passenger Information Display Signs
- Metra Train Information Management System (which includes the Metra Hub)
- Metra Visual Paging System

- Municipal Parking Management Guidance System
- Municipal Transit Operations
- Northeastern Illinois 511 System
- Pace BusInfo Signs
- Pace BusInfo System
- Pace IBS (this element includes the Pace Hub)
- Pace Paratransit Dispatch
- Private Bus Dispatch
- Private ISPs - Travel Information Services
- Private Taxi Dispatch
- Public/Non-Profit Paratransit Services
- Regional Transportation Authority Travel Information Center (TIC)
- RTA InfoTrans Signs (note the name of this element should drop the RTA at the next architecture update)
- RTA Itinerary Planning System
- RTA Multimodal Information Kiosks (note the name of this element should be changed to RTA Travel Information Kiosks at the next architecture update)

These interfaces fall into four general categories:

- Transit Centers (e.g. Chicago Transit Authority Control Center)
- Electronic signs (e.g. Pace BusInfo Signs) or interactive devices for travelers (e.g. kiosks)
- Regional transportation systems (e.g. Illinois Gateway)
- Miscellaneous (e.g. Media)

The interfaces and information flows between the Illinois Transit Hub and the primary Service Board centers are shown in Figure A3-75. Due to the lack of detail in the current architecture representation, this figure provides the interfaces that would address both the Transit Connection Protection, and the inter agency aspects of Regional Fare Collection. A recommendation is to increase the detail in these interfaces in an update to the Regional ITS Architecture to better address both these aspects of the project.



**Figure A3-75: Transit Hub: APTS (ID 75)- Primary Service Board Center Interfaces**

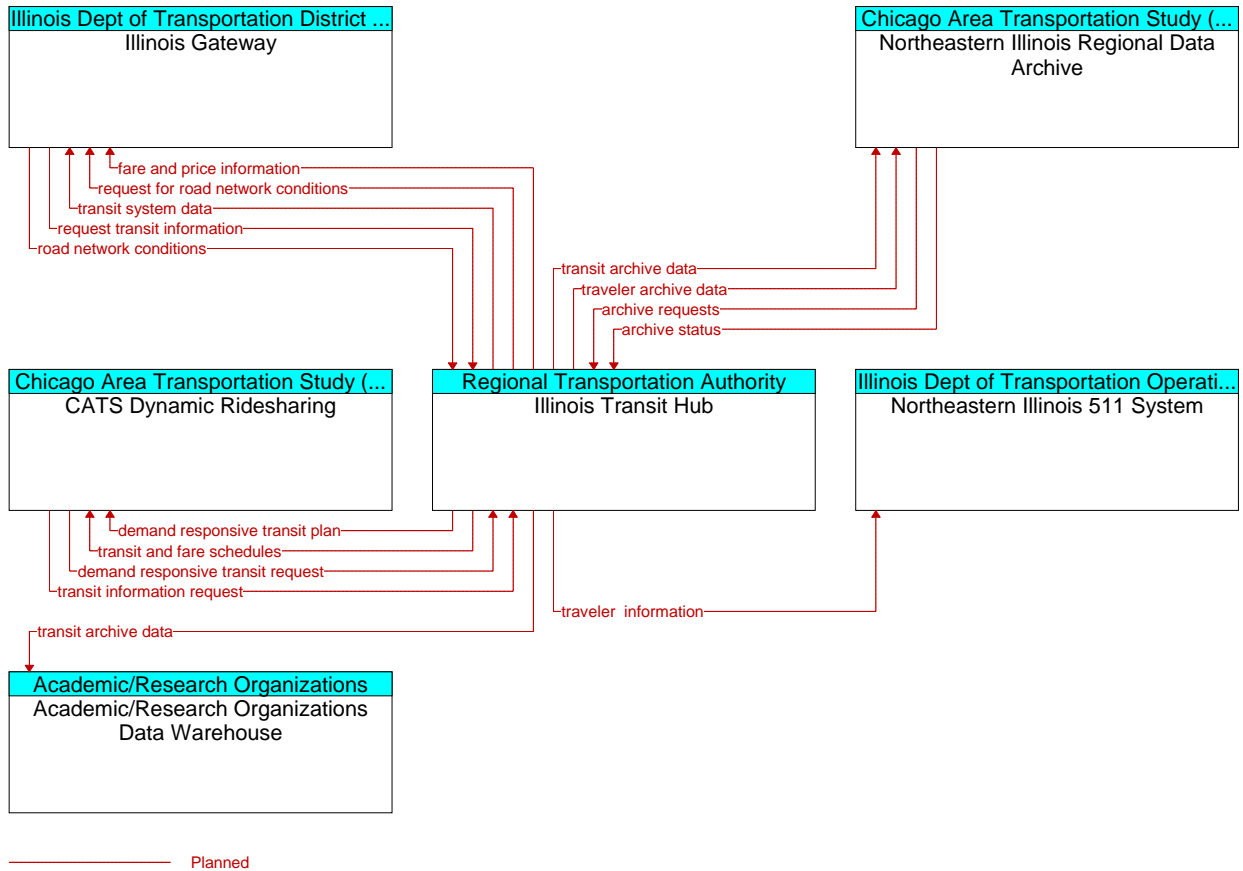
The interfaces and information flows between the Illinois Transit Hub and the various transit signs or traveler information devices are shown in Figure A3-76.



**Figure A3-76: Transit Hub: APTS (ID 75)- Traveler interface device interfaces**

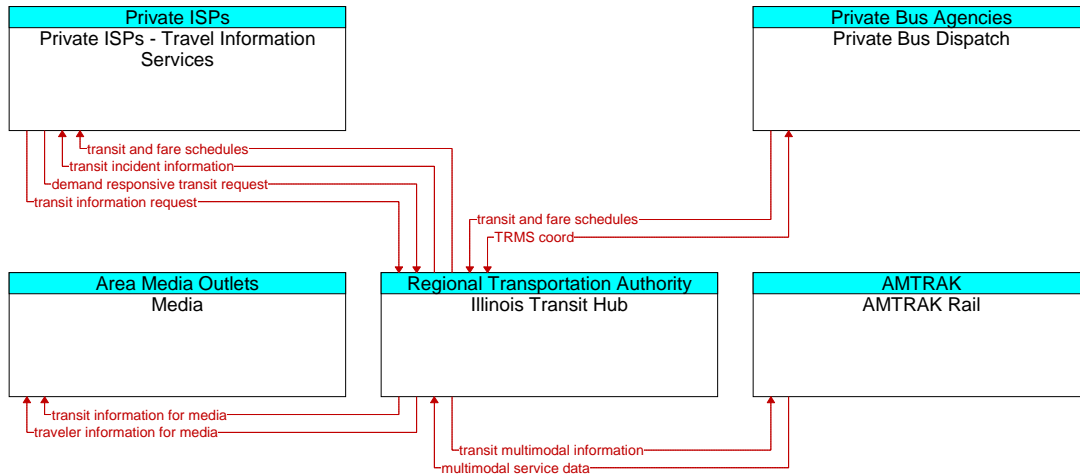
The interfaces and information flows between the Illinois Transit Hub and the various regional transportation systems are shown in Figure A3-77. One additional element and its interface(to the Illinois Transit Hub) should be added to the Regional ITS Architecture at the next update-- the Regional Transit Asset Management System (RTAMS).





**Figure A3-77: Transit Hub: APTS (ID 75)-Regional Transportation System Interfaces**

The interfaces and information flows between the Illinois Transit Hub and the various regional transportation systems are shown in Figure A3-78. The Private Bus Dispatch represents private companies such as Greyhound.



**Figure A3-78: Transit Hub: APTS (ID 75)- Miscellaneous Interfaces**

**A3-10.2 RTA Demo Projects- APTS (ID 76)**

This project is actually a compilation of several individual projects that relate to transit management. The projects are:

- Transit Signal Priority Demonstration—This project provides Transit Signal Priority (TSP) demonstrations, with initial CTA demonstration on Western Avenue and Pace demonstration on Halsted Street.
- Transit Vehicle Probe Data—This project includes a feasibility study, then design, development and implementation of the use of transit location and time information to estimate arterial travel times.
- Wireless Supervisory Control Data Distribution System (WSCDDS)- This project will enable communications of bus service data such as incidents, restoration actions, ad-hoc messages, etc. between CTA field supervisors, bus operators, Control Center controllers and the Illinois Transit Hub.

The first of these projects addresses aspects of the Market Package of Transit Multimodal Coordination (APTS7). The second project relates to the Market Package Probe Surveillance (ATMS2). The final project relates to the Market Package Transit Fixed Route Operations (APTS2).

The elements of the Regional ITS Architecture that relate to these demo projects are:

- Chicago Transit Authority Control Center
- Chicago Transit Authority Bus Vehicles
- PACE IBS
- Pace Transit Bus Vehicles
- City of Chicago DOT TMC

- City of Chicago DOT Roadside Equipment
- IDOT District 1 Bureau of Traffic Signal Unit
- IDOT District 1 Bureau of Traffic Signal Unit Roadside Equipment
- Illinois Transit Hub

The interfaces and information flows covering the projects are shown in Figure A3-79. The road network probe information flows (that are part of the Transit Vehicle Probe Data project) are not in the current Regional ITS Architecture and need to be added to cover this project.

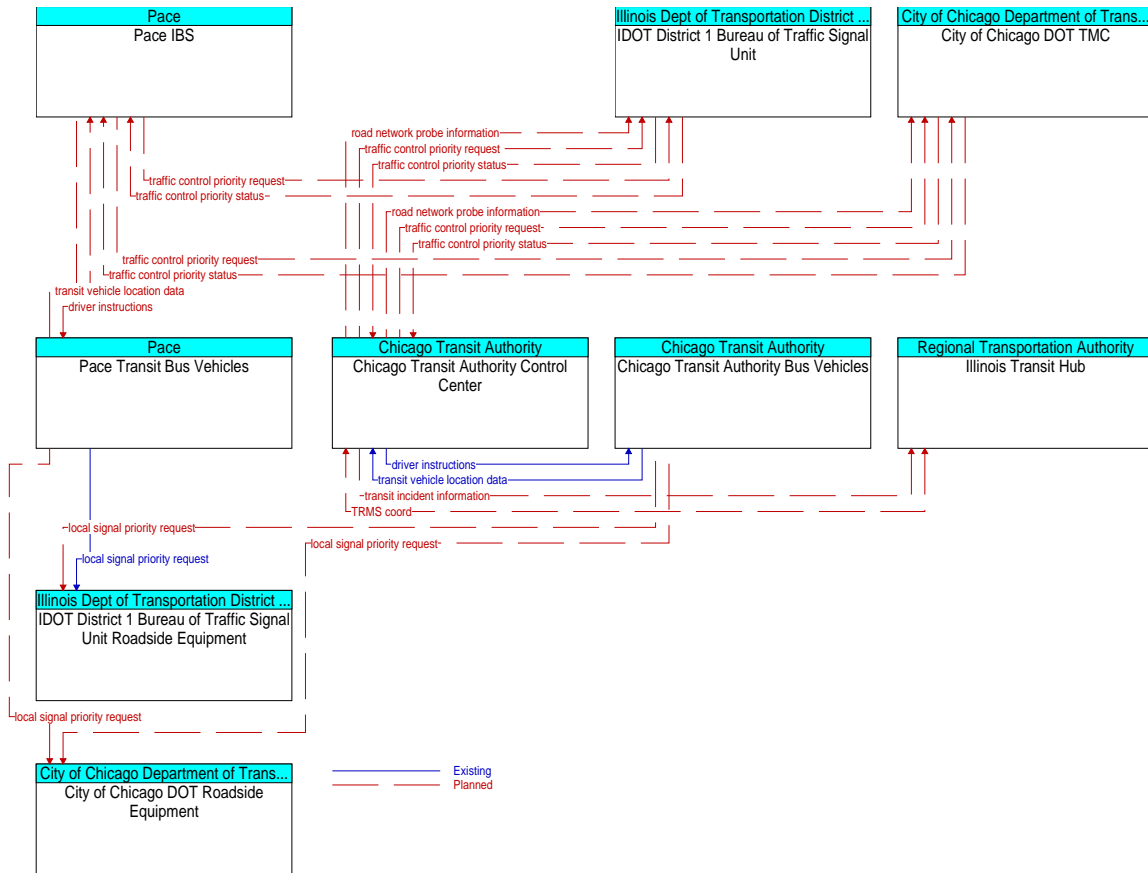


Figure A3-79: RTA Demo Projects- APTS (ID 76)

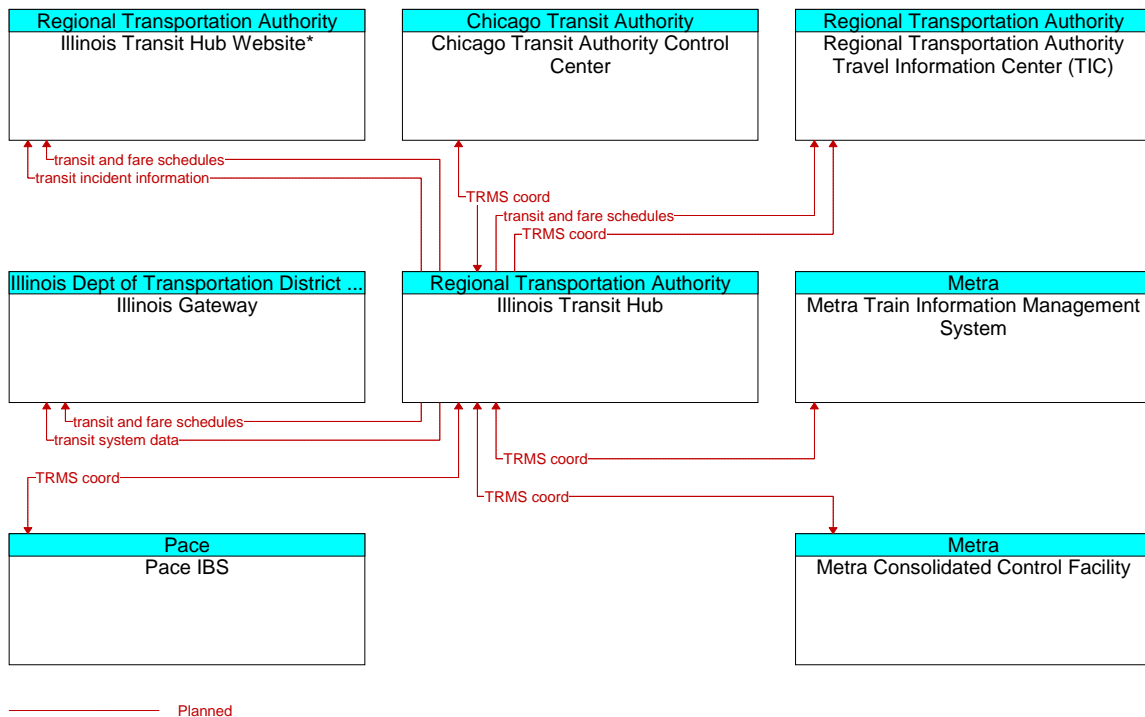
### A3-10.3 Illinois Transit Hub: ATIS (ID 77)

This project entry covers the transit traveler information aspects of the Transit Hub. The project covers dissemination of transit information to Gateway and service boards. Includes development of a Illinois Transit Hub website, and an interface to the RTA Travel Information Center. The Market Package provided by this project is Transit Traveler Information (APTS8).

The elements of the Regional ITS Architecture that relate to these demo projects are:

- Illinois Transit Hub
- Illinois Transit Hub Website\* (This is a new element that is not in the current Regional ITS Architecture)
- Chicago Transit Authority Control Center
- Metra Consolidated Control Facility
- Metra Train Information Management System
- Pace IBS
- Regional Transportation Authority Travel Information Center
- Illinois Gateway

The interfaces and information flows covering the projects are shown in Figure A3-80. The interface to the Illinois Transit Hub Website is not covered in the current Regional ITS Architecture.



**Figure A3-80: Illinois Transit Hub: ATIS (ID 77)**

### A3-10.4 RTA Demo Projects: ATIS (ID 78)

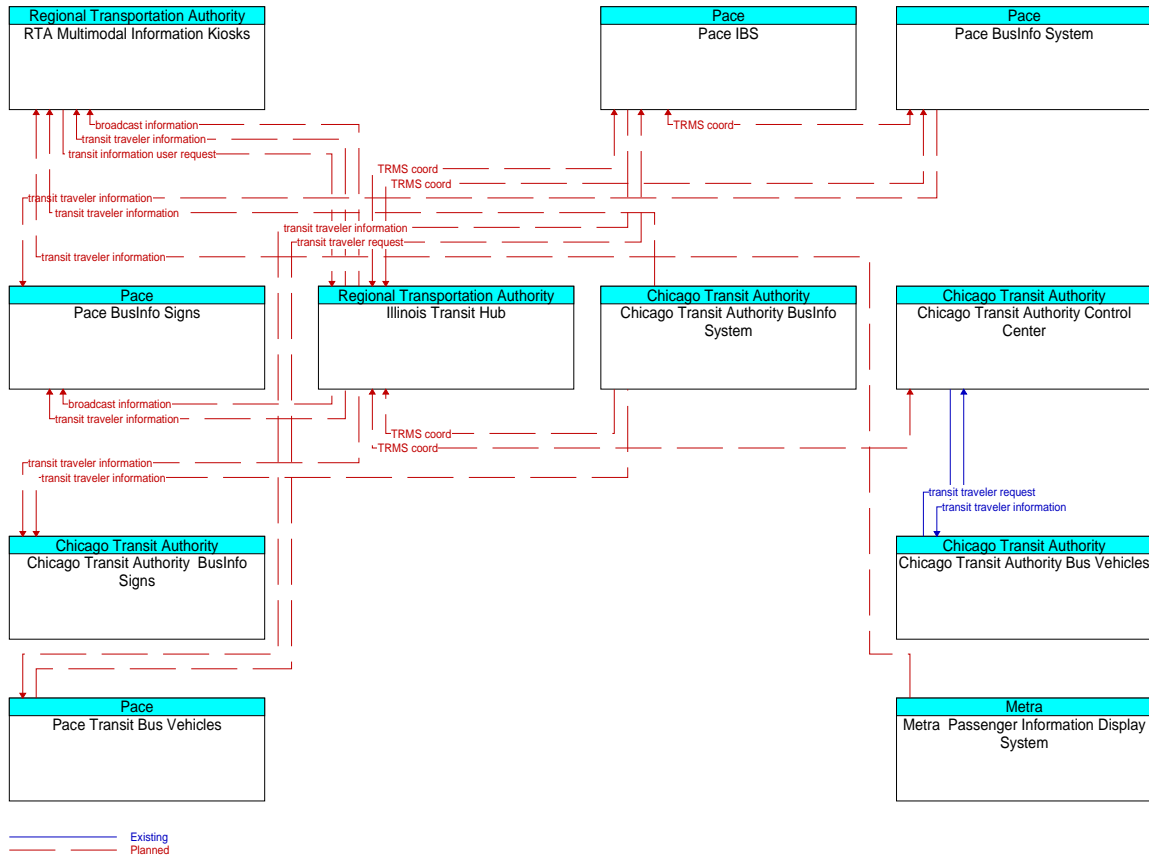
This project heading really covers four separate efforts, whose mapping to the Regional ITS Architecture is described below. The four efforts are:

- BusInfo Initiative—This effort involves integration of bus management with traveler information systems, providing real-time status of bus arrivals from PACE and CTA AVL. Ultimately this system will integrate with Interactive Voice Response, Regional Transit Asset Management System (RTAMS), internet, & Regional Traveler Information Kiosks. (ID 78a)
- Regional Traveler Information Kiosk—This effort will develop and deploy regional multi-modal kiosk based information system with real-time information. The deployment will be in six locations initially. (ID 78b)
- RTA Multi-Modal Trip Planner—This effort involves an enhancement of the existing RTA Itinerary Planning System which will integrate transit and highway planning tools. (78c)
- RTA Active Transit Station Signing Demonstration.—This effort includes deployment of active transit signs that provide countdown to next transit vehicle. (78d)
- InfoTrans – This effort will provide comparative travel times to the Loop between driving and CTA from O’Hare and Midway Airports, provide next train departure information and provide canned and ad-hoc messaging capabilities for Chicago Department of Airports and CTA personnel. (78e)
- Parking Management Guidance System Expansion-- This project will provide parking facility management and parking guidance information via dynamic message signs to users of Metra parking lots. Drawing on results of pilot project (2/05 deployment), this project will expand to 3 other station groups (2-3 stations/group). (78f)

These projects address the Market Packages of

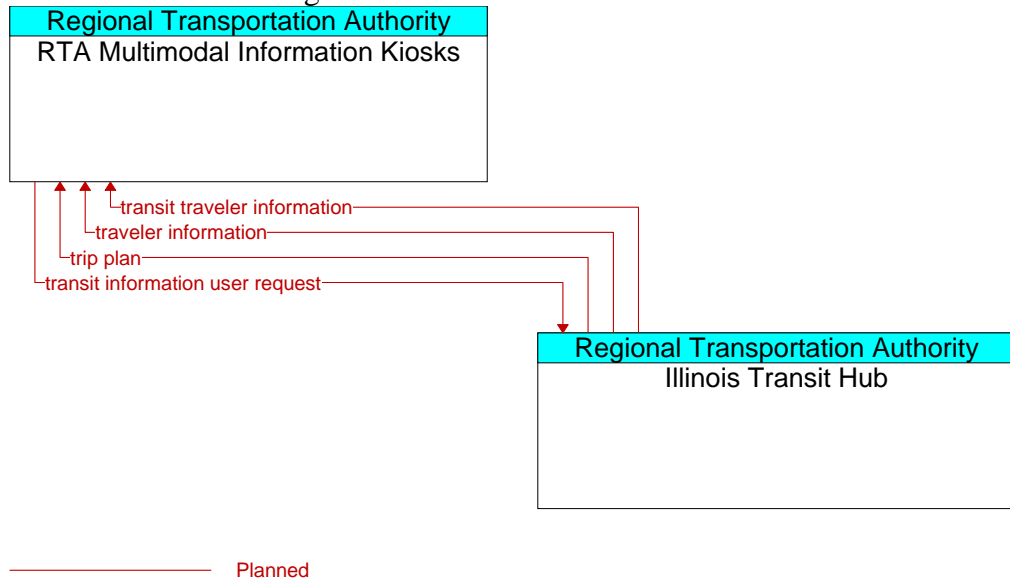
- Transit Traveler Information (projects 78a through 78e) (APTS8)
- Parking Facility Management (project 78f) (ATMS16)

The interfaces and information flows covering the BusInfo Initiative project are shown in Figure A3-81. Figure A3-82 presents the interfaces and information flows for Traveler Information Kiosks.



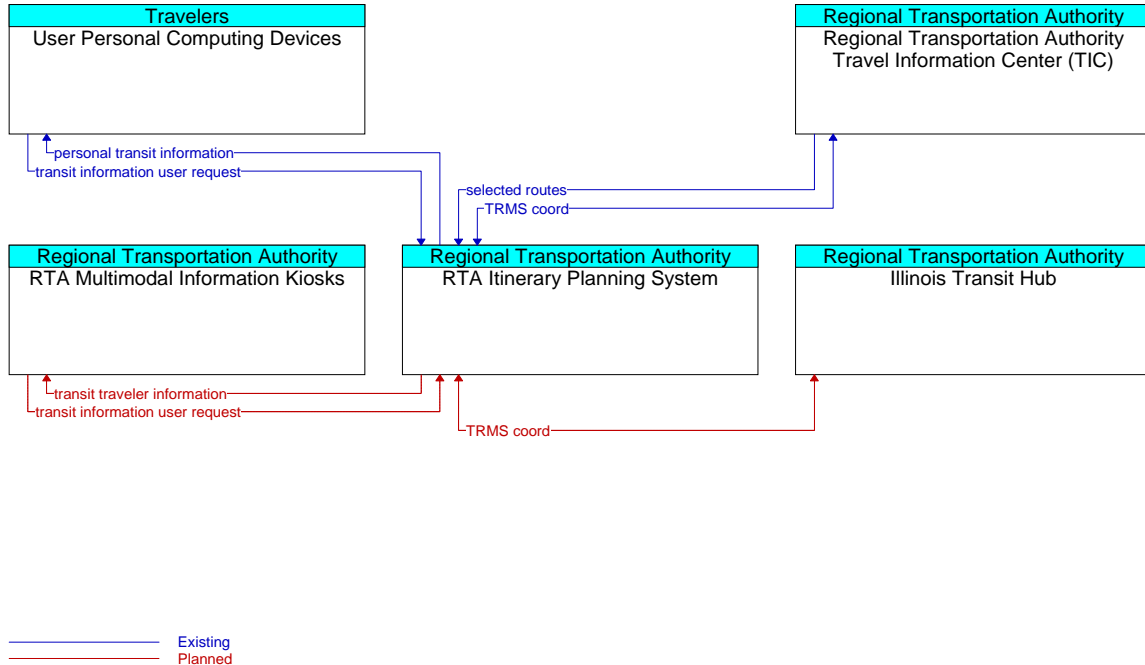
**Figure A3-81: RTA Demo Projects: ATIS- BusInfo Initiative (ID 78a)**

The interface and information flows covering the RTA Regional Traveler Information Kiosks are shown in Figure A3-82.



**Figure A3-82: RTA Demo Projects: ATIS- Regional Traveler Info Kiosks (ID 78b)**

The interfaces and information flows covering the RTA Multi-Modal Trip Planner project are shown in Figure A3-83. Note the interfaces between the RTA Itinerary Planning System and both the RTA TIC and the RTA Multimodal Information Kiosks are not in the current Regional ITS Architecture and will need to be added.

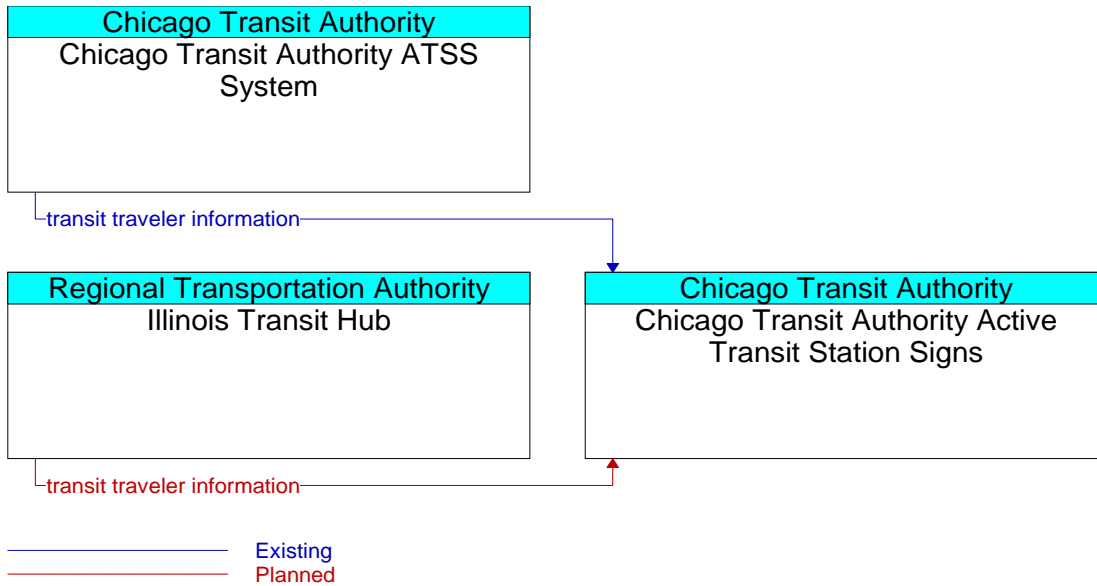


**Figure A3-83: RTA Projects: ATIS- RTA Multi-Modal Trip Planner (ID 78c)**

The elements from the Regional ITS Architecture that relate to the RTA Active Transit Station Signing Demonstration Project are:

- Chicago Transit Authority Active Transit Station Signs
- Chicago Transit Authority ATSS System
- Illinois Transit Hub

The interfaces and information flows covering the ATSS project are shown in Figure A3-84.

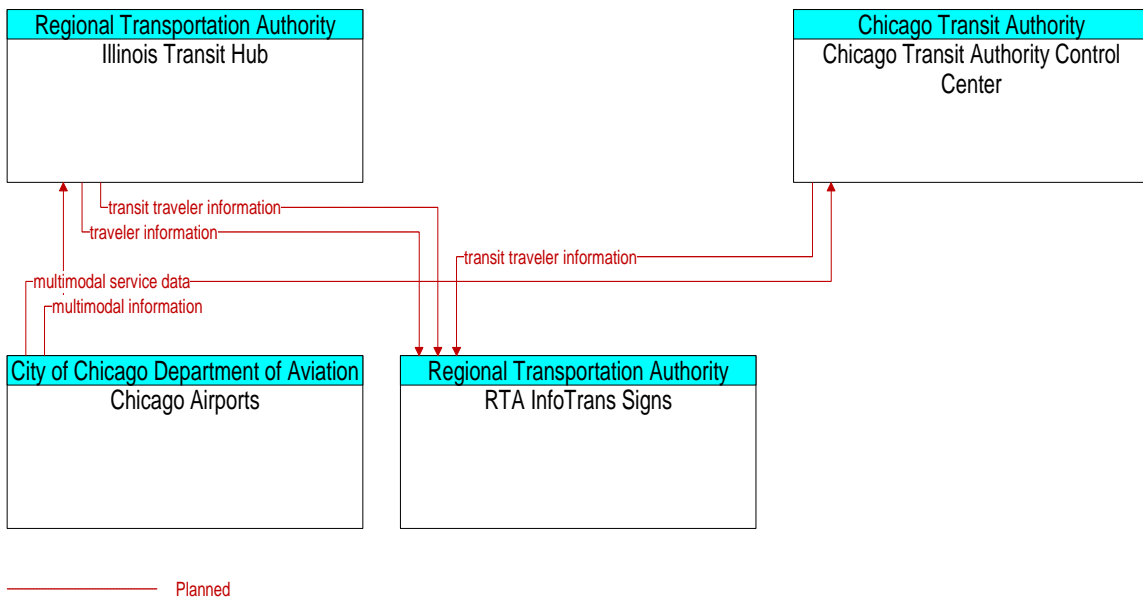


**Figure A3-84: RTA Projects: ATIS- ATSS (ID 78d)**

The elements from the Regional ITS Architecture that relate to the Info Trans project are

- RTA InfoTrans Signs (Note the RTA should be removed from the element name)
- CTA Control Center
- Illinois Transit Hub
- Chicago Airports

The interfaces and information flows covering the Info Trans project are shown in Figure A3-85. Note the interface between Chicago Airports element and the transit elements, as well as the interface between the CTA Control Center and the RTA InfoTrans Signs are not in the current Regional ITS Architecture and will need to be added.



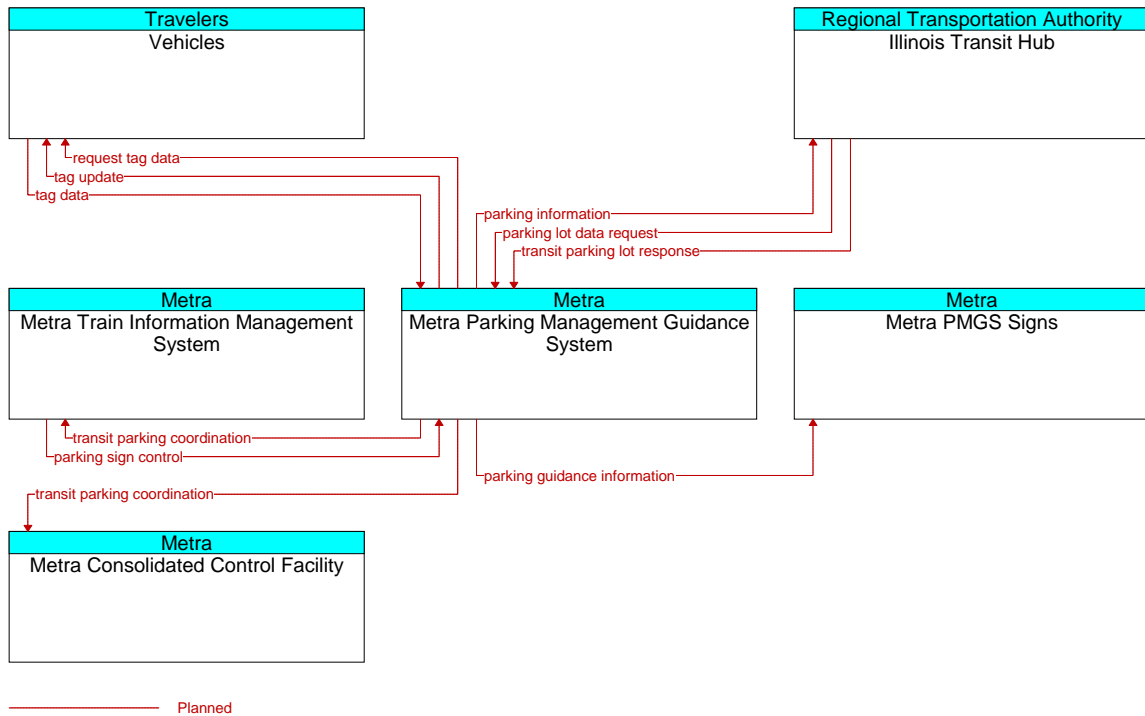
**Figure A3-85: RTA Projects: ATIS- Info Trans (ID 78e)**



The elements from the Regional ITS Architecture that relate to the Parking Management Guidance System project are:

- Metra Parking Management Guidance System
- Metra PMGS Signs
- Metra Train Information Management System
- Metra Consolidated Control Facility
- Illinois Transit Hub
- Vehicles

The interfaces and information flows covering the Parking Management Guidance Systems project are shown in Figure A3-86.



**Figure A3-86: RTA Projects: ATIS- Parking Management Guidance Systems (ID 78f)**

### A3-10.5 Transit Vehicle Safety Projects (ID 79)

This project represents study, design, and implementation of full motion video monitoring of transit vehicles and collision avoidance of transit vehicles. This project provides the Market Packages

- Transit Security (APTS5)
- Lateral Safety Warning (AVSS04)
- Longitudinal Safety Warning (AVSS03)

The elements from the Regional ITS Architecture that relate to this project are:

- Chicago Transit Authority Control Center
- Chicago Transit Authority Bus Vehicles

The interfaces and information flows covering the Transit Vehicle Safety Projects are shown in Figure A3-87. These interfaces relate to the Transit Security market package portions of the project. The Safety Warning portions are implemented by systems contained within the transit vehicles and do not represent any specific interfaces from the Regional ITS Architecture. Note the interfaces flows secure areas surveillance data (and control) are not in the current Regional ITS Architecture and will need to be added.

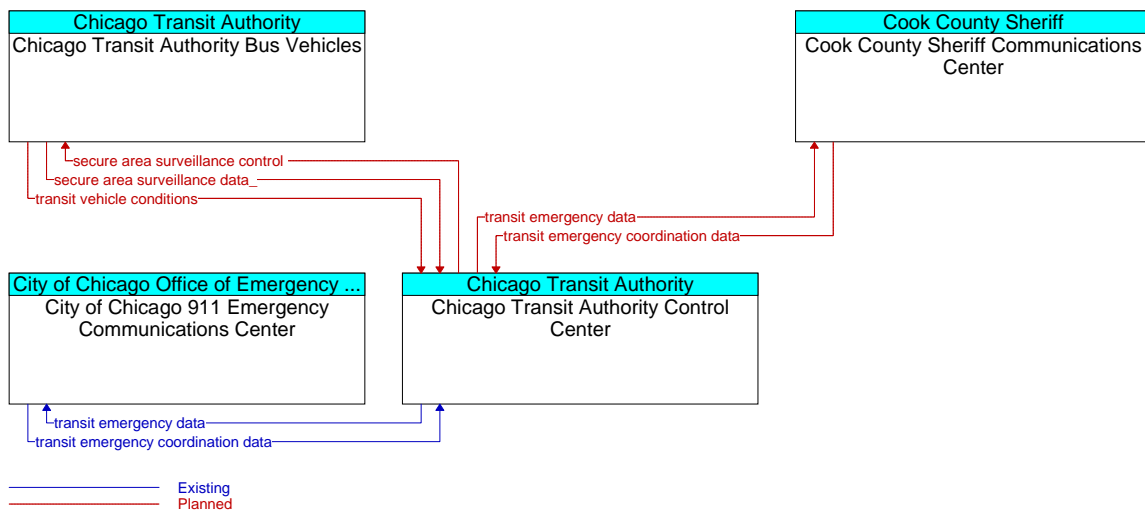


Figure A3-87: RTA Projects: Transit Vehicle Safety Projects (ID 79)

### A3-11 CTA Projects

#### A3-11.1 Automatic Train Supervision (ATS) System (ID 80)

This project provides an updated CTA train tracking system made up of a) full communication of signal indications to CTA control center, b) Centralized Traffic Control (CTC) and c) new software in CTA control center. The Market Package covered by this project is Transit Fixed-Route Operations (APTS2). The elements from the Regional ITS Architecture that relate to these projects are:

- CTA Control Center
- CTA Rapid Transit Vehicles
- CTA Rail Signaling Equipment (this element is not currently in the Regional ITS Architecture)

The interfaces and information flows covering this project are shown in Figure A3-88. The CTA Rail Signaling Equipment element and its interface are not in the current Regional ITS Architecture and would need to be added to it.

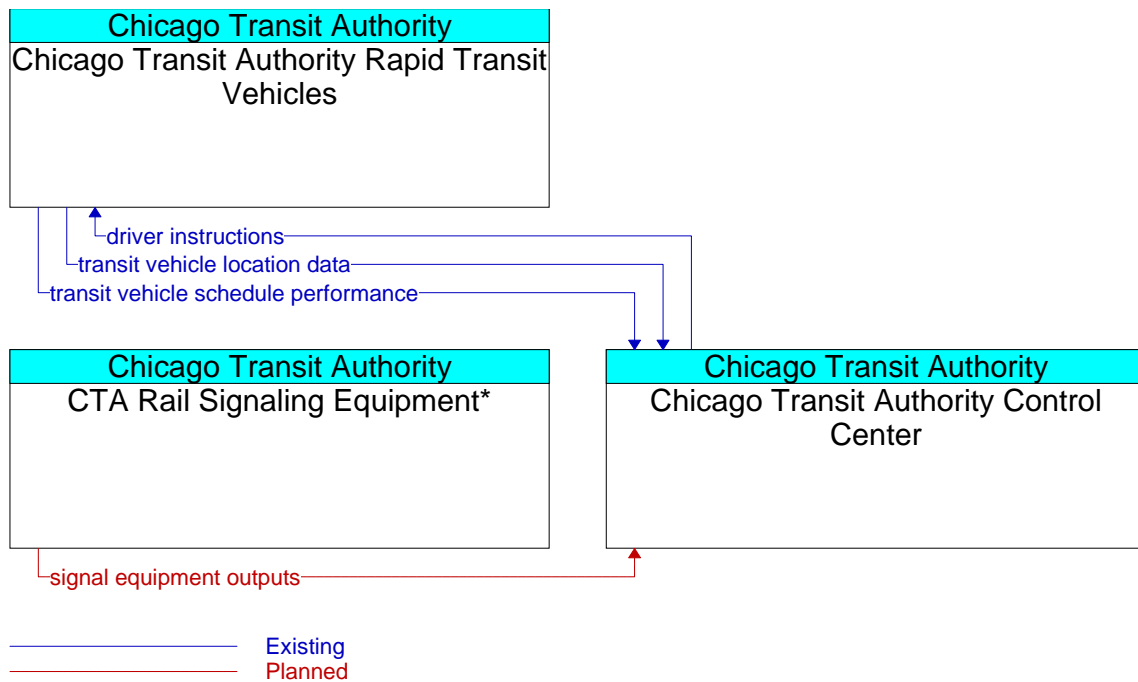


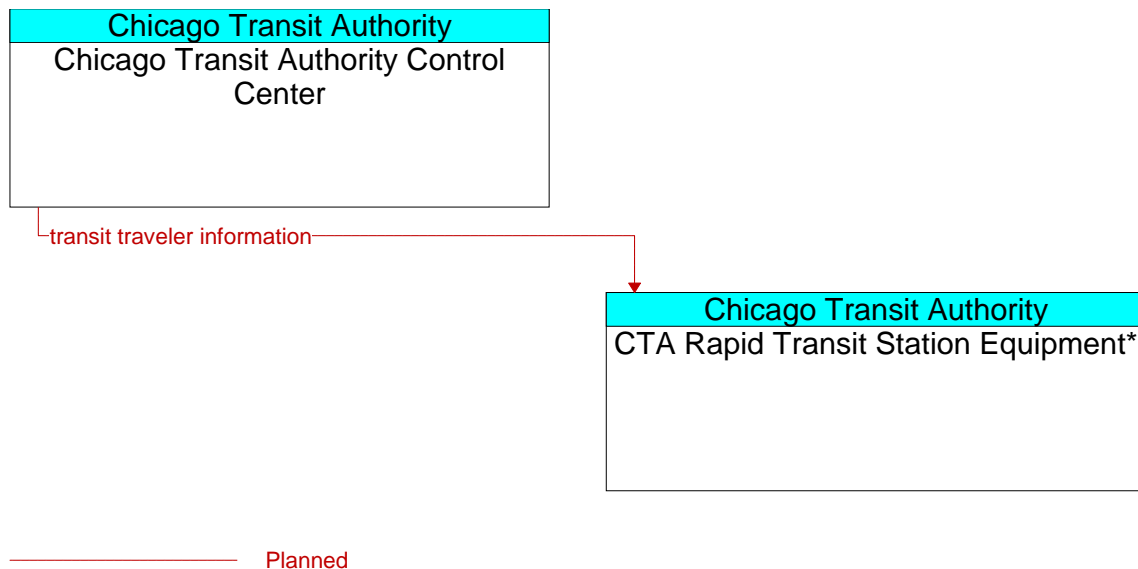
Figure A3-88: Automatic Train Supervision (ATS) System (ID 80)

### A3-11.2 Train Passenger Information System (ID 81)

This project provides LED display of train arrivals at all stations on a countdown clock. The Market Packages covered by this project are Transit Traveler Information (APTS8). The elements from the Regional ITS Architecture that relate to these projects are:

- CTA Control Center
- CTA Rapid Transit Station Equipment\* (this element is not currently in the Regional ITS Architecture)

The interfaces and information flows covering this project are shown in Figure A3-89. The CTA Rapid Transit Station Equipment element and its interface are not in the current Regional ITS Architecture and would need to be added to it.



**Figure A3-89: Train Passenger Information System (ID 81)**

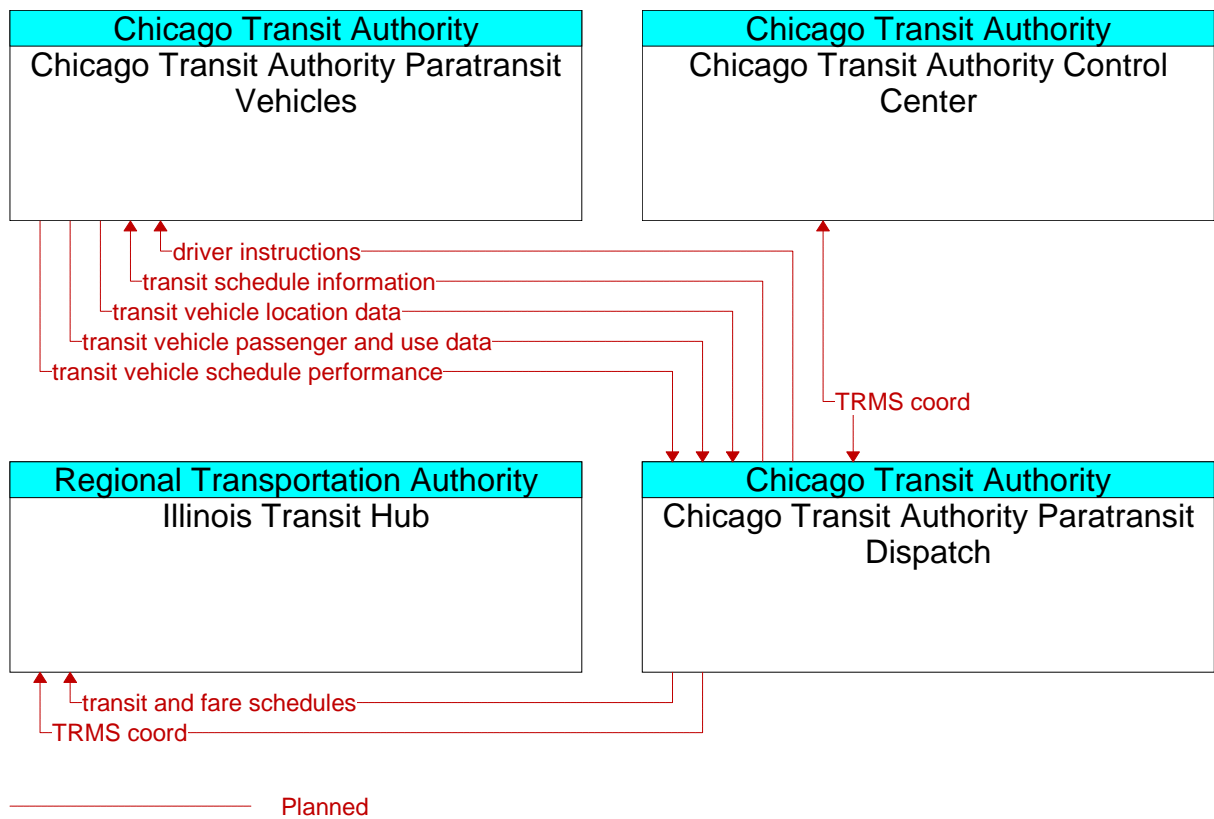
**A3-11.3 CTA Paratransit AVL/MDT (ID 82)**

The project involves equipping of CTA paratransit contract operators with CAD/AVL systems and networking them with the CTA hub and Illinois Transit Hub. The Market Packages covered by this project are Demand Response Transit Management (APTS3) and Multimodal Coordination (APTS7). The elements from the Regional ITS

Architecture that relate to these projects are:

- CTA Paratransit Dispatch
- CTA Paratransit Vehicles
- CTA Control Center
- Illinois Transit Hub

The interfaces and information flows covering this project are shown in Figure A3-90.



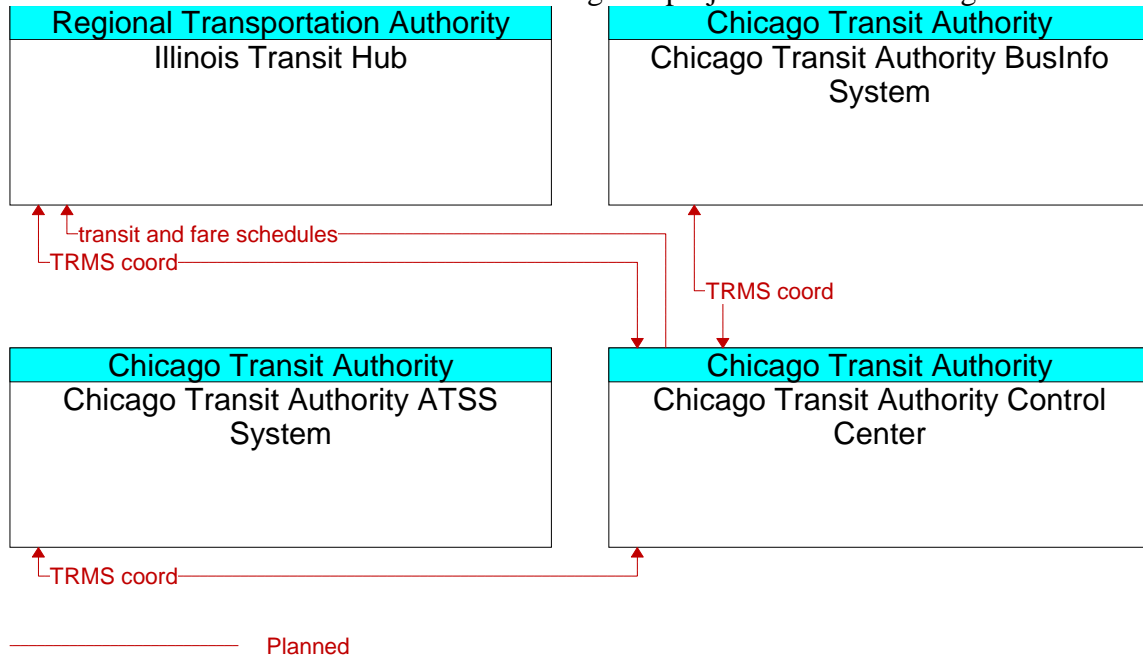
**Figure A3-90: CTA Paratransit AVL/MDT (ID 82)**

**A3-11.4 CTA Hub Enhancements (ID 83)**

This project includes upgrades of the CTA transit management center along with data source interfaces and the modernization of communications networks. The Market Packages covered by this project are Transit Fixed-Route Operations (APTS2) and Multimodal Coordination (APTS7). The elements from the Regional ITS Architecture that relate to these projects are:

- CTA Control Center
- CTA BusInfo System
- CTA ATSS System
- Illinois Transit Hub

The interfaces and information flows covering this project are shown in Figure A3-91.



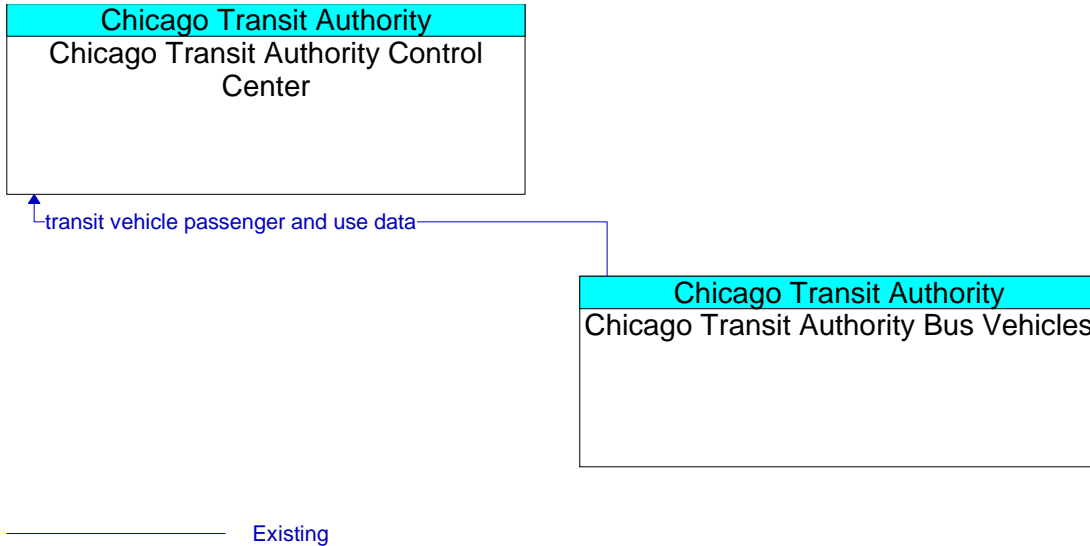
**Figure A3-91: CTA Hub Enhancements (ID 83)**

**A3-11.5 CTA Automatic Passenger Counter (APC) System Replacement (ID 84)**

This project involves replacement of Automatic Passenger Counter (APC) units for fixed-route buses and provides for the networking of the APC with on-board processors. The Market Package covered by this project is the passenger aspect of Transit Passenger and Fare Management (APTS4). The elements from the Regional ITS Architecture that relate to these projects are:

- CTA Control Center
- CTA Bus Vehicles

The interfaces and information flows covering this project are shown in Figure A3-92.



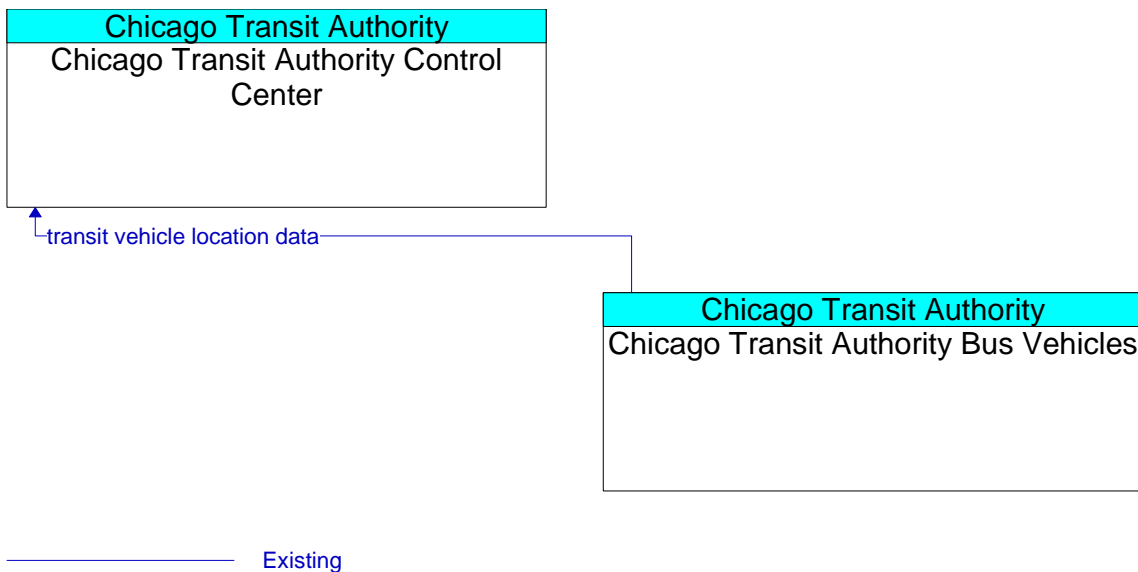
**Figure A3-92: CTA Automatic Passenger Counter System (ID 84)**

**A3-11.6 CTA AVL Upgrade (ID 85)**

This project involves upgrades of the current AVL systems to improve tracking capabilities for CTA Buses. This could be implemented with "Wireless Hot Spots" as a means of communicating with Buses. The Market Package covered by this project is Transit Vehicle Tracking (APTS1). The elements from the Regional ITS Architecture that relate to this project are:

- CTA Control Center
- CTA Bus Vehicles

The interfaces and information flows covering this project are shown in Figure A3-93.



**Figure A3-93: CTA AVL Upgrade (ID 85)**

**A3-11.7 CTA Maintenance Managers Information Management System (MIMS) (ID 86)**

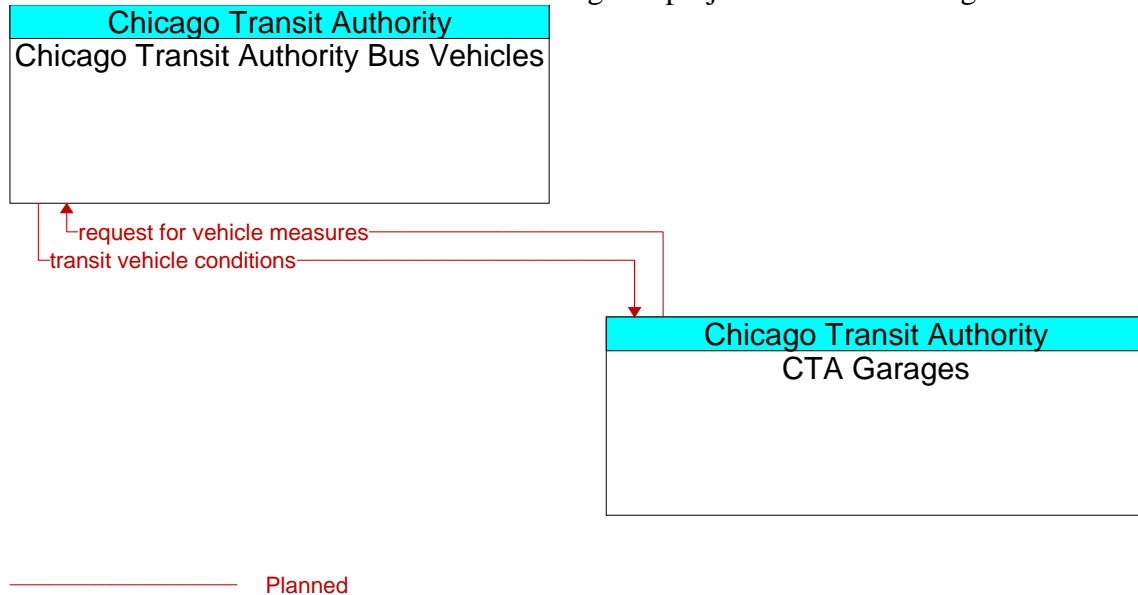
This project involves creation of a Maintenance Managers Information Management System (MIMS) with links to CTA databases and legacy systems. System will collect maintenance information on the CTA fleet and other assets. Currently the Regional ITS Architecture does not have elements or interfaces to support this project- these will need to be added at the next update.

**A3-11.8 CTA AVM Initiative (ID 87)**

This project adding the capability for automated vehicle monitoring (AVM) for maintenance needs for about 410 buses, with the information read as buses enter garages. The Market Package covered by this project is Transit Maintenance (APTS6). The elements from the Regional ITS Architecture that relate to this project are:

- CTA Maintenance Garages\* (This is a new element not in the current Regional ITS Architecture)
- CTA Bus Vehicles

The interfaces and information flows covering this project are shown in Figure A3-94.



**Figure A3-94: CTA AVM Initiative (ID 87)**

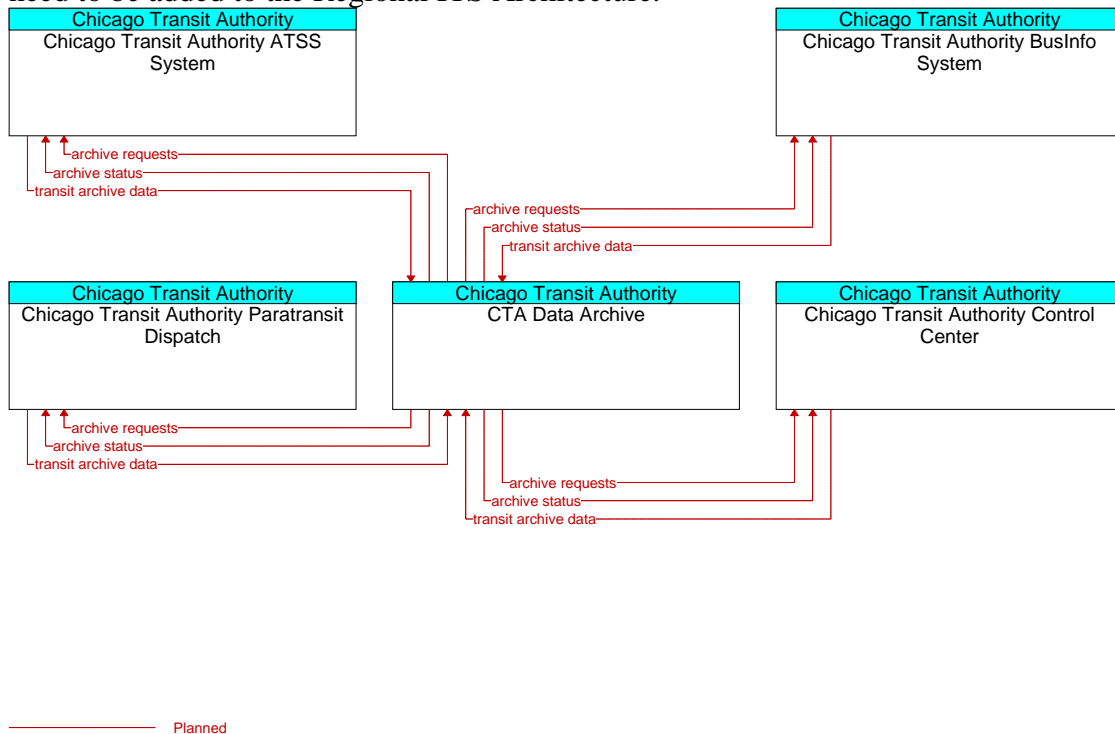


**A3-11.9 CTA Archive (ID 88)**

This project involves development of a CTA transit data archive. The Market Package provided by this project is ITS Data Mart (AD1). There are currently no elements in the Regional ITS Architecture that would correspond to this archive. The project would probably involve collection of data from CTA centers such as:

- CTA Control Center
- CTA Paratransit Dispatch
- CTA BusInfo System
- CTA ATSS System

A simple set of interfaces and elements that might apply to this project are shown in Figure A3-95. The new element, CTA Data Archive, and the appropriate interfaces will need to be added to the Regional ITS Architecture.



**Figure A3-95: CTA Archive (ID 88)**

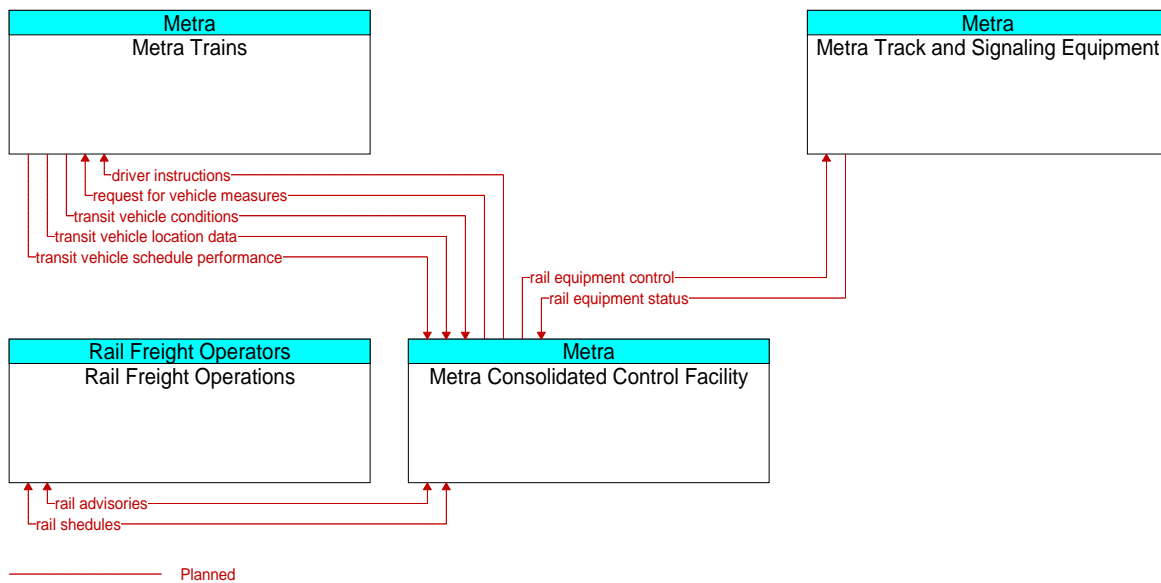
### A3-12 Metra Projects

#### A3-12.1 Metra Rail Dispatch & Signaling System Upgrade (ID 89)

This project would consider improvements in Metra rail dispatch and signaling systems operated out of the Consolidated Control Facility. The Market package provided by this project is Transit Fixed Route Operations (in this case- Train Control System) (APTS2). The elements from the Regional ITS Architecture that relate to this project are:

- Metra Consolidated Control Facility
- Metra Trains
- Rail Freight Operations
- Metra Track and Signaling Equipment (this element is not in the current Regional ITS Architecture)

The interfaces and information flows covering this project are shown in Figure A3-96. The element “Metra Track and Signaling Equipment” and its interface are not in the current Regional ITS Architecture. Neither is the interface between the Metra CCF and Rail Freight Operations.



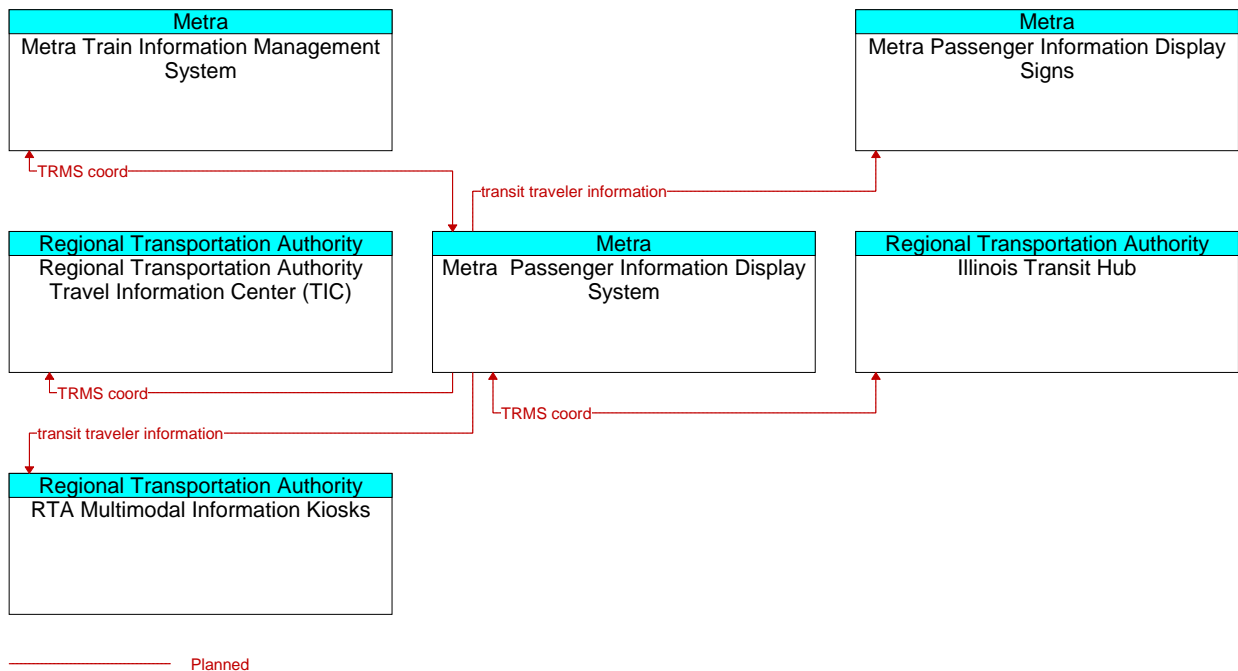
**Figure A3-96: Metra Rail Dispatch & Signaling System Upgrade (ID 89)**

**A3-12.2 PIDS Modernization (ID 90)**

This project involves a replacement system for the visual passenger information displays (PIDS) at downtown terminal stations. The Market Package covered by this project is Transit Traveler Information (APTS8). The elements from the Regional ITS Architecture that relate to this project are:

- Metra Passenger Information Display System
- Metra Passenger Information Display Signs
- RTA Multimodal Information Kiosks
- Metra Train Information Management System
- Illinois Transit Hub
- RTA Traveler Information Center

The interfaces and information flows covering this project are shown in Figure A3-97.



**Figure A3-97: PIDS Modernization (ID 90)**

**A3-12.3 Emergency Management Messaging (ID 91)**

This project will provide emergency management and messaging at about 8 signs per station. Exact types of messages to be displayed have yet to be determined. The Market Package covered by this project is Transit Security (APTS5). This project is not currently covered in the Regional ITS Architecture and would need to be added at the next update. Considerations for adding it are whether new elements for the signs and the emergency management system that drive them should be added or whether existing elements will perform this function.

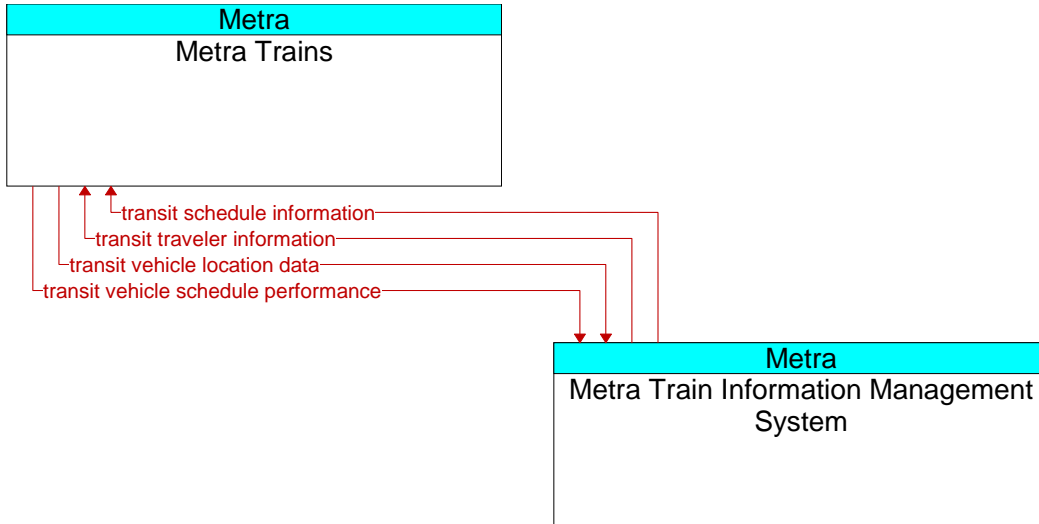
**A3-12.4 Metra TIMS Enhancements (ID 92)**

This project will provide upgrade and enhancement of Train Information Management System (TIMS). Using GPS, TIMS provides real-time train location information to riders

via automated audio and visual announcements. The Market Package covered by this project is Transit Traveler Information (APTS8). The elements from the Regional ITS Architecture that relate to this project are:

- Metra Train Information Management System
- Metra Trains

The interfaces and information flows covering this project are shown in Figure A3-98.

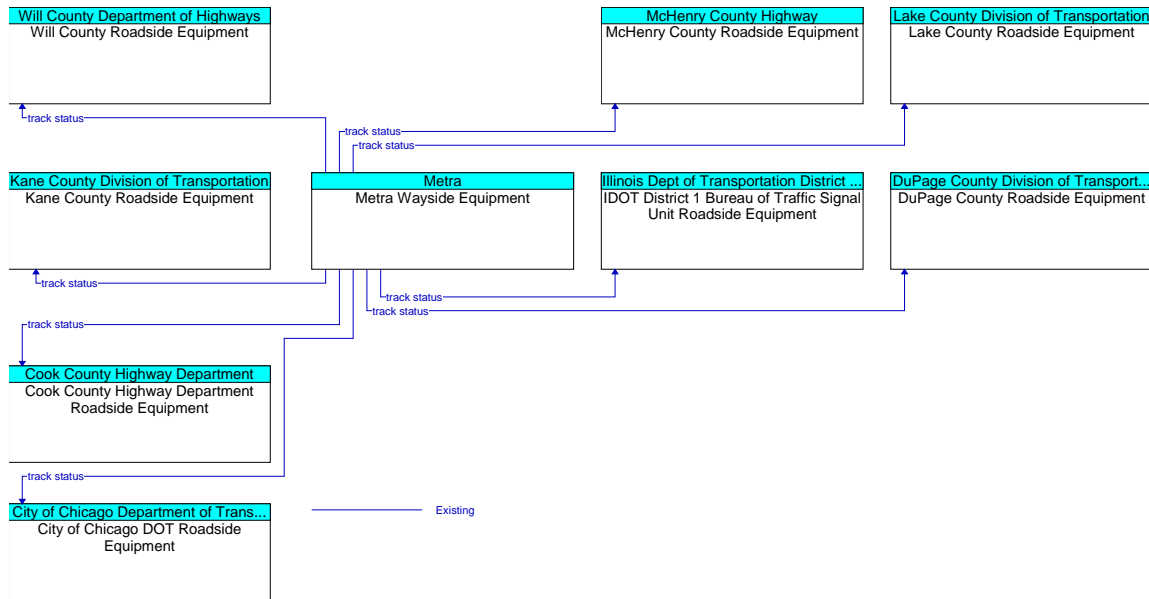


Planned

Figure A3-98: Metra TIMS Enhancements (ID 92)

**A3-12.5 Constant Time Warning at Grade Crossings (ID 93)**

This project will upgrade Metra wayside equipment to provide a constant time warning to the crossing gates and to the traffic management equipment nearby. The Market Package covered by this project is Standard Railroad Grade Crossing (ATMS13). The elements from the Regional ITS Architecture involved in the project are the Metra Wayside Equipment and the various roadside elements shown in the following diagram. The interfaces and information flows covering this project are shown in Figure A3-99.



**Figure A3-99: Constant Time Warning at Grade Crossings (ID 93)**

### A3-13 Pace Projects

#### A3-13.1 Pace Intelligent Bus System (ID 94)

This project is the continuation of an on-going effort to deploy an integrated bus management system incorporating automatic vehicle location and fleet management technologies. The Market Packages covered by this project are Transit Vehicle Tracking (APTS1), Transit Fixed Route Operations (APTS2) and Transit Security (APTS5) and Transit Traveler Information (APTS8). The elements from the Regional ITS Architecture that relate to this project are:

- PACE IBS
- PACE Transit Bus Vehicles
- Illinois Transit Hub

The interfaces and information flows covering the other traveler information projects are shown in Figure A3-100.

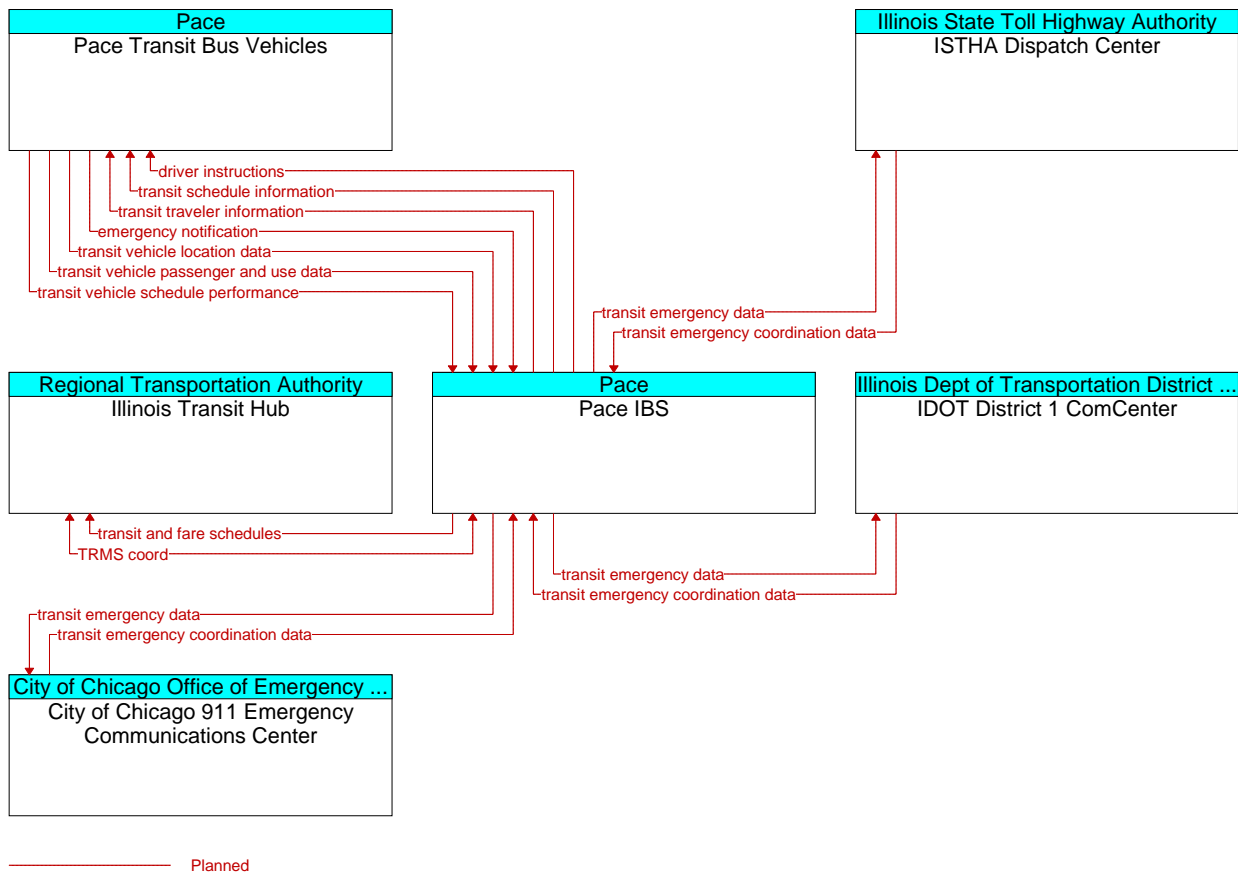


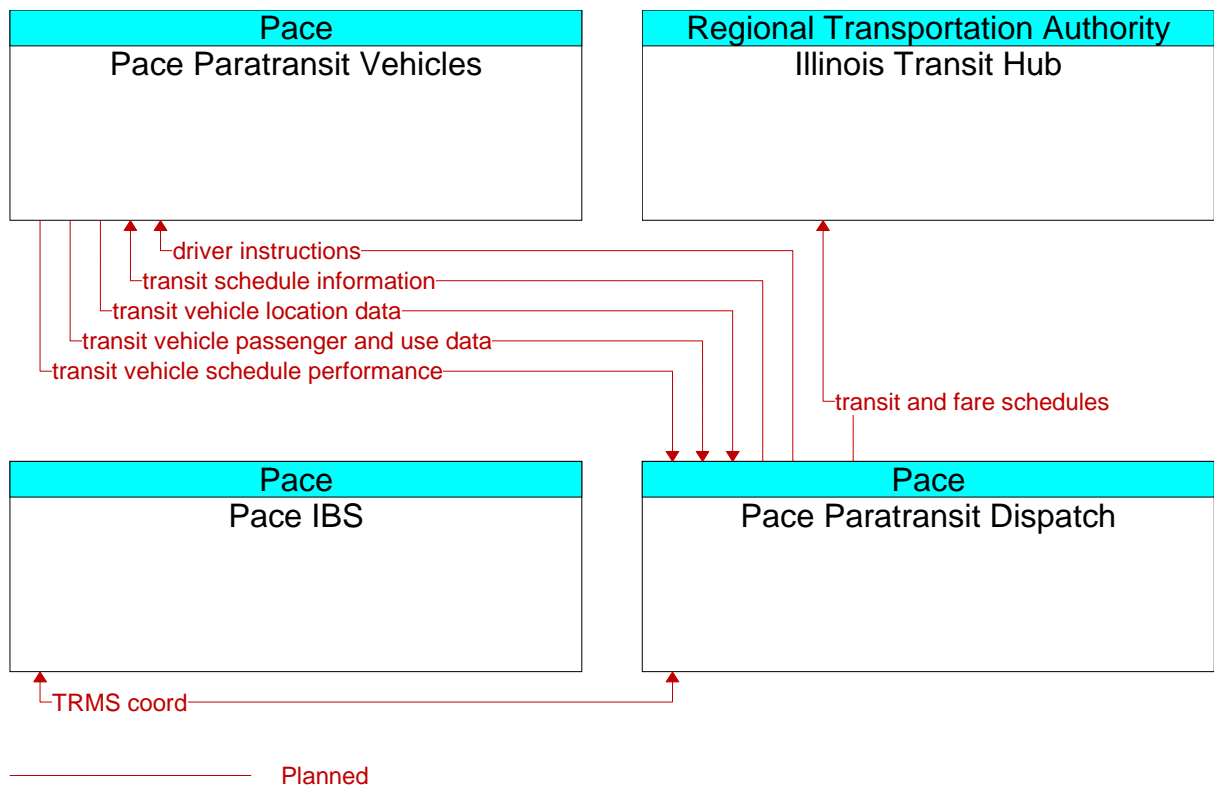
Figure A3-100: Pace Intelligent Bus System (ID 94)

**A3-13.2 Pace Paratransit MDT/AVL (ID 95)**

This project will deploy a paratransit management system consisting of mobile data terminals with AVL in conjunction with Trapeze software’s PASS automated scheduling system. The Market Packages covered by this project are Transit Vehicle Tracking (APTS1) and Demand Response Transit Operations (APTS3). The elements from the Regional ITS Architecture that relate to this project are:

- Pace Paratransit Dispatch
- Pace Paratransit Vehicles
- Illinois Transit Hub

The interfaces and information flows covering the other traveler information projects are shown in Figure A3-101.



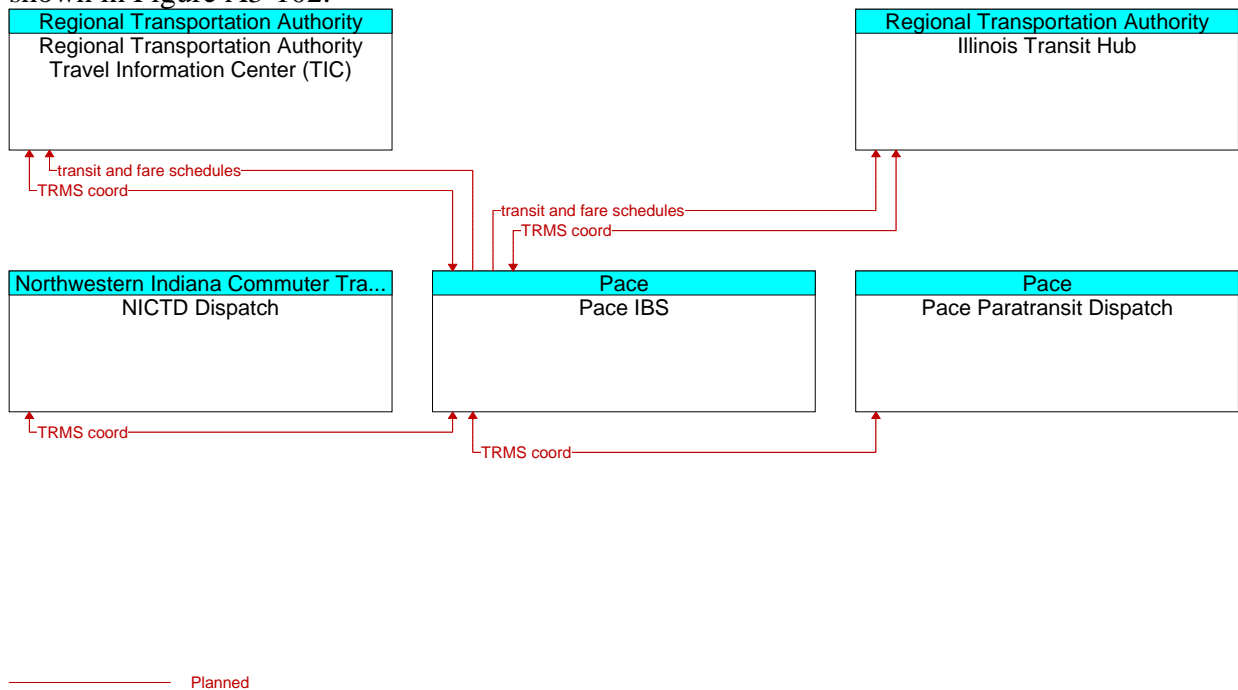
**Figure A3-101: Pace Paratransit MDT/AVL (ID 95)**

### A3-13.3 Pace Hub Enhancement (ID 96)

This project will establish a hub server, data source interfaces along with modernization of communications networks. The Pace Hub will be located at the Arlington Heights office. The Market Package covered by this project is Multimodal Coordination (APTS7). The elements from the Regional ITS Architecture that relate to this project are:

- Pace IBS
- Pace Paratransit Dispatch
- Illinois Transit Hub

The interfaces and information flows covering the other traveler information projects are shown in Figure A3-102.



**Figure A3-102: Pace Hub Enhancement (ID 96)**

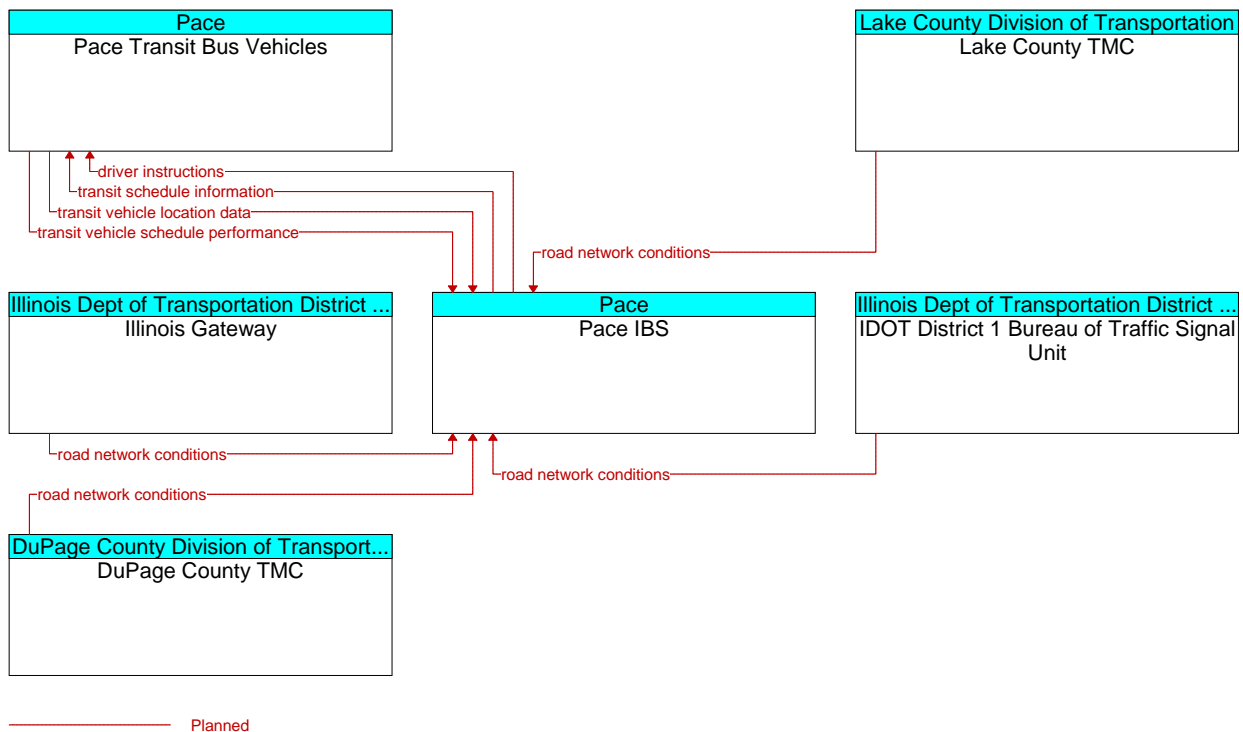


**A3-13.4 Pace Transit Operations Decision Support System (ID 97)**

This project will create a system that will quickly develop new bus routes when an incident impacts an existing route. The Market Package covered by this project is Transit Fixed Route Operations (APTS2). The elements from the Regional ITS Architecture that relate to this project are:

- Pace IBS
- Pace Paratransit Vehicles
- Traffic Management Elements (See figure below)

The interfaces and information flows covering the other traveler information projects are shown in Figure A3-103.



**Figure A3-103: Pace Transit Operations Decision Support System (ID 97)**

**A3-13.5 Pace Demo Projects: Queue Jump Lane (ID 98)**

This project will create a system with bus-specific signal indications and signs will give early green to allow bus to move ahead of long traffic queues at signalized intersections. While this system has similarities, from an architecture standpoint, with the transit signal priority project (ID 100), it is not directly covered by the current Regional ITS Architecture and would need to be added at the next update.

**A3-13.4 Pace Demo Projects: Driver Assistive Navigational Technology (ID 99)**

This project will provide systems that will equip transit vehicles with driver assistive technology that will enable a driver to better guide a wide bus on a narrow shoulder or lanes, especially under difficult conditions. From an architecture standpoint, this involves systems that are completely within the transit vehicle, so the project does not cover any specific interface within the Regional ITS Architecture unless information regarding the operation of the systems is sent from the vehicle to the transit operations center.

**A3-13.4 Region Wide Transit Signal Priority Deployment (ID 100)**

This project will provide a system that will give priority to Pace buses at traffic signals in the region. The Market Package covered by this project is Multi-modal Coordination (APTS7). The elements from the Regional ITS Architecture that relate to this project are:

- Pace IBS
- Pace Transit Bus Vehicles
- Traffic Management Elements (See figure below)
- Roadway Elements (See figure below)

The interfaces and information flows covering the other traveler information projects are shown in Figure A3-104.

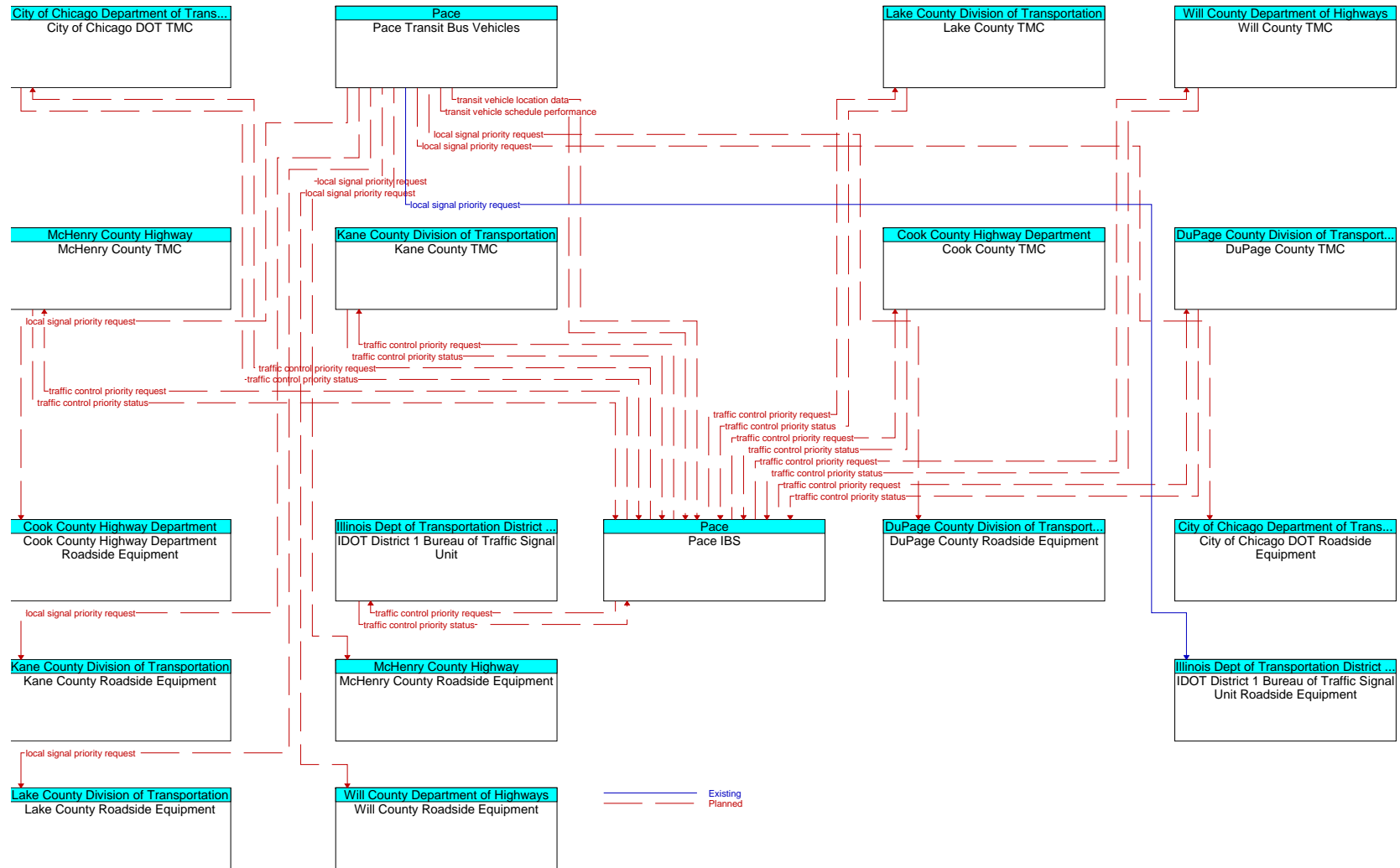


Figure A3-104: Wide Transit Signal Priority Deployment (ID 100)

(This page left intentionally blank.)

## Appendix 6 Missing Interfaces per Gap Analysis

This appendix provides a detailed listing of interfaces that are missing, that is, where gaps exist between the project list and the Regional ITS Architecture. The information is organized by the market packages covered in the Section 8.3 Gap Analysis. For each of the 10 market packages, the missing interface is defined in terms of Source, Flow Name (information flow on the interface) and Destination.

Following is an index to the missing interfaces by market package.

<u>Market Package</u>	<u>Ap 6 Page(s)</u>
AD2 - ITS Data Warehouse	1
APTS5 - Transit Security	2-3
APTS6 – Transit Maintenance	4
ATIS8 – Dynamic Ridesharing	5
ATMS05 – HOV Lane Management	6
ATMS08 – Incident Management	7-42
EM1 – Emergency Response	43-61
MC06 – Winter Maintenance	62-69
MC07 – Roadway Maintenance & Construction	70-75
MC10 – Maintenance & Construction Activity Coordination	76-80

<b>Source</b>	<b>Flow Name</b>	<b>Destination</b>
Academic/Research Organizations Data Warehouse	archive requests	Chicago Airports
Academic/Research Organizations Data Warehouse	archive status	Chicago Airports
Academic/Research Organizations Data Warehouse	archive requests	Gateway Central
Academic/Research Organizations Data Warehouse	archive status	Gateway Central
Academic/Research Organizations Data Warehouse	archive analysis requests	GCM Data Archive
Academic/Research Organizations Data Warehouse	archived data product requests	GCM Data Archive
Academic/Research Organizations Data Warehouse	archive analysis requests	Northeastern Illinois Regional Data Archive
Academic/Research Organizations Data Warehouse	archived data product requests	Northeastern Illinois Regional Data Archive
Centerpoint Intermodal Facility	intermodal freight archive data	Northeastern Illinois Regional Data Archive
Chicago Airports	multimodal archive data	Academic/Research Organizations Data Warehouse
Chicago Airports	multimodal archive data	Northeastern Illinois Regional Data Archive
Gateway Central	traffic archive data	Academic/Research Organizations Data Warehouse
GCM Data Archive	archive analysis results	Academic/Research Organizations Data Warehouse
GCM Data Archive	archived data products	Academic/Research Organizations Data Warehouse
GCM Data Archive	archive request confirmation	Academic/Research Organizations Data Warehouse
IDOT Emergency Traffic Patrol (ETP)	emergency archive data	IDOT District 1 ComCenter
Illinois Gateway	traffic archive data	Academic/Research Organizations Data Warehouse
Illinois Gateway	traffic archive data	Northeastern Illinois Regional Data Archive
Northeastern Illinois Regional Data Archive	archive analysis results	Academic/Research Organizations Data Warehouse
Northeastern Illinois Regional Data Archive	archived data products	Academic/Research Organizations Data Warehouse
Northeastern Illinois Regional Data Archive	archive request confirmation	Academic/Research Organizations Data Warehouse
Northeastern Illinois Regional Data Archive	archive requests	Chicago Airports
Northeastern Illinois Regional Data Archive	archive status	Chicago Airports
Northeastern Illinois Regional Data Archive	archive requests	Illinois Gateway
Northeastern Illinois Regional Data Archive	archive status	Illinois Gateway
Weather Services	transportation weather information	City of Chicago DOT TMC
Weather Services	transportation weather information	IDOT District 1 ComCenter

Source	Flow Name	Destination
Chicago Transit Authority Control Center	emergency acknowledge	Chicago Transit Authority Rapid Transit Vehicles
Chicago Transit Authority Control Center	transit emergency data	IDOT District 1 ComCenter
Chicago Transit Authority Paratransit Dispatch	transit emergency data	IDOT District 1 ComCenter
Chicago Transit Authority Paratransit Dispatch	transit incident information	IDOT District 1 ComCenter
City of Chicago 911 Emergency Communications Center	transit emergency coordination data	Independent School District Dispatch
Cook County Sheriff Communications Center	transit emergency coordination data	Independent School District Dispatch
DuPage Centralized Paratransit Dispatch	transit emergency data	DuPage County EOC
DuPage Centralized Paratransit Dispatch	transit emergency data	IDOT District 1 ComCenter
DuPage Centralized Paratransit Dispatch	transit emergency data	Illinois State Police Dispatch (Districts 2, 5 and Chicago)
DuPage Centralized Paratransit Dispatch	transit emergency data	Illinois State Police District 15 Operations Desk
DuPage Centralized Paratransit Dispatch	transit emergency data	Will County Sheriff Communications Center
DuPage County EOC	transit emergency coordination data	DuPage Centralized Paratransit Dispatch
DuPage County EOC	transit emergency coordination data	Metra Consolidated Control Facility
DuPage County Sheriff Communications Center	transit emergency coordination data	Independent School District Dispatch
IDOT District 1 ComCenter	transit emergency coordination data	Chicago Transit Authority Control Center
IDOT District 1 ComCenter	transit emergency coordination data	Chicago Transit Authority Paratransit Dispatch
IDOT District 1 ComCenter	transit emergency coordination data	DuPage Centralized Paratransit Dispatch
IDOT District 1 ComCenter	transit emergency coordination data	Independent School District Dispatch
IDOT District 1 ComCenter	transit emergency coordination data	Pace Paratransit Dispatch
Illinois State Police Dispatch (Districts 2, 5 and Chicago)	transit emergency coordination data	Independent School District Dispatch
Independent School District Dispatch	transit emergency data	City of Chicago 911 Emergency Communications Center
Independent School District Dispatch	transit emergency data	Cook County Sheriff Communications Center
Independent School District Dispatch	transit emergency data	DuPage County Sheriff Communications Center
Independent School District Dispatch	transit emergency data	IDOT District 1 ComCenter
Independent School District Dispatch	transit emergency data	Kane County 911 Center
Independent School District Dispatch	transit emergency data	Lake County Communications Center
Independent School District Dispatch	transit emergency data	McHenry County Sheriff Dispatch
Independent School District Dispatch	transit emergency data	Municipal Public Safety Dispatch
Independent School District Dispatch	transit emergency data	Will County Sheriff Communications Center
ISTHA Dispatch Center	transit emergency coordination data	Chicago Transit Authority Control Center

APTS5

Source	Flow Name	Destination
Kane County 911 Center	transit emergency coordination data	Independent School District Dispatch
Lake County Communications Center	transit emergency coordination data	Independent School District Dispatch
McHenry County Sheriff Dispatch	transit emergency coordination data	Independent School District Dispatch
Metra Consolidated Control Facility	transit emergency data	City of Chicago 911 Emergency Communications Center
Metra Consolidated Control Facility	transit emergency data	Illinois State Police Dispatch (Districts 2, 5 and Chicago)
Metra Consolidated Control Facility	emergency acknowledge	Metra Trains
Metra Consolidated Control Facility	secure area monitoring support	Metra Visual Paging System
Metra Consolidated Control Facility	transit emergency data	Municipal Public Safety Dispatch
Metra Trains	emergency notification	Metra Consolidated Control Facility
Metra Visual Paging System	secure area surveillance data	Metra Consolidated Control Facility
Municipal Public Safety Dispatch	transit emergency coordination data	Independent School District Dispatch
Municipal Public Safety Dispatch	transit emergency coordination data	Metra Consolidated Control Facility
Will County Sheriff Communications Center	transit emergency coordination data	Independent School District Dispatch



APTS6

<b>Source</b>	<b>Flow Name</b>	<b>Destination</b>
Chicago Transit Authority Paratransit Dispatch	request for vehicle measures	Chicago Transit Authority Paratransit Vehicles
Chicago Transit Authority Paratransit Vehicles	transit vehicle conditions	Chicago Transit Authority Paratransit Dispatch
DuPage Centralized Paratransit Dispatch	request for vehicle measures	DuPage Paratransit Vehicles
DuPage Paratransit Vehicles	transit vehicle conditions	DuPage Centralized Paratransit Dispatch

ATIS8

<b>Source</b>	<b>Flow Name</b>	<b>Destination</b>
CATS Dynamic Ridesharing	ISP coordination	Private ISPs - Travel Information Services
CATS Dynamic Ridesharing	trip plan	IDOT Metro Kiosks
CATS Dynamic Ridesharing	transit information request	Illinois Transit Hub
CATS Dynamic Ridesharing	trip plan	User Personal Computing Devices
IDOT Metro Kiosks	trip confirmation	CATS Dynamic Ridesharing
IDOT Metro Kiosks	trip request	CATS Dynamic Ridesharing
Illinois Transit Hub	demand responsive transit plan	CATS Dynamic Ridesharing
Illinois Transit Hub	transit and fare schedules	CATS Dynamic Ridesharing
Private ISPs - Travel Information Services	ISP coordination	CATS Dynamic Ridesharing
User Personal Computing Devices	trip confirmation	CATS Dynamic Ridesharing
User Personal Computing Devices	trip request	CATS Dynamic Ridesharing

ATMS05

Source	Flow Name	Destination
IDOT District 1 Traffic Systems Center (TSC)	freeway control data	IDOT District 1 Traffic Systems Center Roadside Equipment
IDOT District 1 Traffic Systems Center (TSC)	traffic sensor control	IDOT District 1 Traffic Systems Center Roadside Equipment
IDOT District 1 Traffic Systems Center Roadside Equipment	freeway control status	IDOT District 1 Traffic Systems Center (TSC)
IDOT District 1 Traffic Systems Center Roadside Equipment	traffic flow	IDOT District 1 Traffic Systems Center (TSC)

Source	Flow Name	Destination
*999 Cellular Express Line	incident information	IDOT District 1 Traffic Systems Center (TSC)
*999 Cellular Express Line	incident response status	IDOT District 1 Traffic Systems Center (TSC)
*999 Cellular Express Line	incident report	Illinois State Police Dispatch (Districts 2, 5 and Chicago)
*999 Cellular Express Line	incident response coordination	Illinois State Police Dispatch (Districts 2, 5 and Chicago)
*999 Cellular Express Line	incident information	ISTHA TMC (TIMS)
*999 Cellular Express Line	incident response status	ISTHA TMC (TIMS)
AMTRAK Rail	railroad advisories	City of Chicago DOT TMC
AMTRAK Rail	railroad schedules	City of Chicago DOT TMC
Borman Traffic Management Center	incident information	IDOT District 1 ComCenter
Borman Traffic Management Center	resource deployment status	IDOT District 1 ComCenter
Borman Traffic Management Center	road network conditions	IDOT District 1 ComCenter
Borman Traffic Management Center	traffic information coordination	IDOT District 1 ComCenter
Borman Traffic Management Center	incident information	Illinois State Police District 15 Operations Desk
Borman Traffic Management Center	road network conditions	Illinois State Police District 15 Operations Desk
Borman Traffic Management Center	traffic information coordination	ISTHA TMC (TIMS)
Chicago Bureau of Convention and Tourism Database	event plans	City of Chicago 311 Center
City of Chicago 311 Center	incident report	City of Chicago 911 Emergency Communications Center
City of Chicago 911 Emergency Communications Center	incident report	City of Chicago 311 Center
City of Chicago 911 Emergency Communications Center	maint and constr resource request	City of Chicago DSS BOE Signal Maintenance
City of Chicago 911 Emergency Communications Center	incident report	City of Chicago Emergency Operations Center
City of Chicago 911 Emergency Communications Center	incident response coordination	City of Chicago Emergency Operations Center
City of Chicago 911 Emergency Communications Center	incident information	City of Chicago Skyway Operations
City of Chicago 911 Emergency Communications Center	remote surveillance control	City of Chicago Skyway Operations
City of Chicago 911 Emergency Communications Center	resource request	City of Chicago Skyway Operations
City of Chicago 911 Emergency Communications Center	incident report	Coast Guard Dispatch
City of Chicago 911 Emergency Communications Center	incident response coordination	Coast Guard Dispatch
City of Chicago 911 Emergency Communications Center	incident response coordination	Cook County Sheriff Communications Center
City of Chicago 911 Emergency Communications Center	incident report	DuPage County EOC
City of Chicago 911 Emergency Communications Center	incident response coordination	DuPage County EOC
City of Chicago 911 Emergency Communications Center	incident response status	IDOT District 1 ComCenter
City of Chicago 911 Emergency Communications Center	remote surveillance control	IDOT District 1 ComCenter
City of Chicago 911 Emergency Communications Center	resource request	IDOT District 1 ComCenter
City of Chicago 911 Emergency Communications Center	incident information	IDOT District 1 Traffic Systems Center (TSC)
City of Chicago 911 Emergency Communications Center	incident response status	IDOT District 1 Traffic Systems Center (TSC)
City of Chicago 911 Emergency Communications Center	remote surveillance control	IDOT District 1 Traffic Systems Center (TSC)
City of Chicago 911 Emergency Communications Center	resource request	IDOT District 1 Traffic Systems Center (TSC)
City of Chicago 911 Emergency Communications Center	incident report	IDOT Emergency Traffic Patrol (ETP)
City of Chicago 911 Emergency Communications Center	incident response coordination	IDOT Emergency Traffic Patrol (ETP)
City of Chicago 911 Emergency Communications Center	incident report	Illinois State Police District 15 Operations Desk
City of Chicago 911 Emergency Communications Center	incident response coordination	Illinois State Police District 15 Operations Desk
City of Chicago 911 Emergency Communications Center	incident information	Indiana DOT Arterial TMC

Source	Flow Name	Destination
City of Chicago 911 Emergency Communications Center	resource request	Indiana DOT Arterial TMC
City of Chicago 911 Emergency Communications Center	incident report	Indiana State Police Dispatch
City of Chicago 911 Emergency Communications Center	incident response coordination	Indiana State Police Dispatch
City of Chicago 911 Emergency Communications Center	incident information	Indiana Toll Road Operations Center
City of Chicago 911 Emergency Communications Center	resource request	Indiana Toll Road Operations Center
City of Chicago 911 Emergency Communications Center	incident information	Satellite TMC OHare Airport
City of Chicago 911 Emergency Communications Center	remote surveillance control	Satellite TMC OHare Airport
City of Chicago 911 Emergency Communications Center	resource request	Satellite TMC OHare Airport
City of Chicago 911 Emergency Communications Center	maint and constr resource request	Utility Company Dispatch
City of Chicago Bureau of Street Operations Dispatch	maint and constr resource response	City of Chicago 911 Emergency Communications Center
City of Chicago Bureau of Street Operations Dispatch	maint and constr resource coordination	City of Chicago DOT BOS Roadway Maintenance
City of Chicago Bureau of Street Operations Dispatch	maint and constr resource coordination	City of Chicago DSS BOE Signal Maintenance
City of Chicago Bureau of Street Operations Dispatch	maint and constr resource coordination	City of Chicago DSS Traffic Services Dispatch
City of Chicago Bureau of Street Operations Dispatch	maint and constr resource coordination	Cook County Highway Department Maintenance Bureau
City of Chicago Bureau of Street Operations Dispatch	maint and constr resource coordination	IDOT District 1 ComCenter
City of Chicago Bureau of Street Operations Dispatch	maint and constr resource coordination	IDOT District 1 Maintenance Management
City of Chicago Bureau of Street Operations Dispatch	maint and constr resource coordination	ISTHA Maintenance and Construction
City of Chicago Bureau of Street Operations Dispatch	maint and constr resource coordination	Municipal/ Township Maintenance
City of Chicago DOT BOS Roadway Maintenance	maint and constr resource coordination	City of Chicago Bureau of Street Operations Dispatch
City of Chicago DOT BOS Roadway Maintenance	maint and constr resource coordination	City of Chicago DSS BOE Signal Maintenance
City of Chicago DOT BOS Roadway Maintenance	maint and constr resource coordination	City of Chicago DSS Traffic Services Dispatch
City of Chicago DOT BOS Roadway Maintenance	maint and constr resource coordination	Cook County Highway Department Construction Bureau
City of Chicago DOT BOS Roadway Maintenance	maint and constr resource coordination	Cook County Highway Department Maintenance Bureau
City of Chicago DOT BOS Roadway Maintenance	maint and constr resource coordination	IDOT District 1 Bureau of Construction
City of Chicago DOT BOS Roadway Maintenance	maint and constr resource coordination	IDOT District 1 Bureau of Traffic- Expressway Operations Unit
City of Chicago DOT BOS Roadway Maintenance	incident information	IDOT District 1 Bureau of Traffic Signal Unit
City of Chicago DOT BOS Roadway Maintenance	maint and constr resource response	IDOT District 1 Bureau of Traffic Signal Unit
City of Chicago DOT BOS Roadway Maintenance	incident information	IDOT District 1 ComCenter
City of Chicago DOT BOS Roadway Maintenance	maint and constr resource coordination	IDOT District 1 ComCenter
City of Chicago DOT BOS Roadway Maintenance	incident information	Illinois Gateway
City of Chicago DOT TMC	video surveillance control	City of Chicago DSS Roadside Equipment
City of Chicago DOT TMC	maint and constr resource request	City of Chicago DSS Traffic Services Dispatch
City of Chicago DOT TMC	traffic information coordination	City of Chicago Skyway Operations
City of Chicago DOT TMC	maint and constr resource request	IDOT District 1 ComCenter
City of Chicago DOT TMC	resource deployment status	IDOT District 1 ComCenter
City of Chicago DOT TMC	maint and constr resource request	IDOT District 1 Maintenance Management
City of Chicago DOT TMC	incident information	IDOT District 1 Maintenance Management
City of Chicago DOT TMC	road network conditions	IDOT District 1 Traffic Systems Center (TSC)
City of Chicago DOT TMC	traffic information coordination	Indiana DOT Arterial TMC
City of Chicago DOT TMC	traffic information coordination	Indiana Toll Road Operations Center
City of Chicago DOT TMC	event confirmation	Mayors Office of Special Events

ATMS08

Source	Flow Name	Destination
City of Chicago DOT TMC	road network conditions	Private ISPs - Travel Information Services
City of Chicago DOT Transportation Website	request for road network conditions	City of Chicago DOT TMC
City of Chicago DOT Transportation Website	request for road network conditions	IDOT District 1 Traffic Systems Center (TSC)
City of Chicago DSS BOE Signal Maintenance	maint and constr resource response	City of Chicago 911 Emergency Communications Center
City of Chicago DSS BOE Signal Maintenance	maint and constr resource coordination	City of Chicago Bureau of Street Operations Dispatch
City of Chicago DSS BOE Signal Maintenance	maint and constr resource coordination	City of Chicago DOT BOS Roadway Maintenance
City of Chicago DSS BOE Signal Maintenance	incident information	City of Chicago DOT TMC
City of Chicago DSS BOE Signal Maintenance	maint and constr resource response	City of Chicago DOT TMC
City of Chicago DSS BOE Signal Maintenance	maint and constr resource coordination	City of Chicago DSS Traffic Services Dispatch
City of Chicago DSS BOE Signal Maintenance	maint and constr resource coordination	Cook County Highway Department Maintenance Bureau
City of Chicago DSS BOE Signal Maintenance	maint and constr resource coordination	IDOT District 1 Bureau of Construction
City of Chicago DSS BOE Signal Maintenance	maint and constr resource response	IDOT District 1 Bureau of Traffic Signal Unit
City of Chicago DSS BOE Signal Maintenance	incident information	IDOT District 1 ComCenter
City of Chicago DSS BOE Signal Maintenance	maint and constr resource coordination	IDOT District 1 ComCenter
City of Chicago DSS BOE Signal Maintenance	maint and constr resource coordination	IDOT District 1 Maintenance Management
City of Chicago DSS BOE Signal Maintenance	incident information	Illinois Gateway
City of Chicago DSS BOE Signal Maintenance	maint and constr resource coordination	Municipal/ Township Maintenance
City of Chicago DSS BOE Signal Maintenance	maint and constr resource coordination	Private Sector Maintenance Contractor
City of Chicago DSS Roadside Equipment	traffic images	City of Chicago DOT TMC
City of Chicago DSS Traffic Services Dispatch	maint and constr resource coordination	City of Chicago Bureau of Street Operations Dispatch
City of Chicago DSS Traffic Services Dispatch	maint and constr resource coordination	City of Chicago DOT BOS Roadway Maintenance
City of Chicago DSS Traffic Services Dispatch	maint and constr resource response	City of Chicago DOT TMC
City of Chicago DSS Traffic Services Dispatch	maint and constr resource coordination	City of Chicago DSS BOE Signal Maintenance
City of Chicago DSS Traffic Services Dispatch	maint and constr resource response	City of Chicago Skyway Operations
City of Chicago DSS Traffic Services Dispatch	maint and constr resource coordination	IDOT District 1 ComCenter
City of Chicago DSS Traffic Services Dispatch	maint and constr resource response	Private Tow and Recovery Operations
City of Chicago Emergency Operations Center	incident report	City of Chicago 911 Emergency Communications Center
City of Chicago Emergency Operations Center	incident response coordination	City of Chicago 911 Emergency Communications Center
City of Chicago Emergency Operations Center	incident report	Cook County EOC
City of Chicago Emergency Operations Center	incident response coordination	Cook County EOC
City of Chicago Emergency Operations Center	incident report	DuPage County EOC
City of Chicago Emergency Operations Center	incident response coordination	DuPage County EOC
City of Chicago Emergency Operations Center	incident report	IDOT District 1 ComCenter
City of Chicago Emergency Operations Center	incident response coordination	IDOT District 1 ComCenter
City of Chicago Emergency Operations Center	incident information	Illinois Gateway
City of Chicago Emergency Operations Center	incident report	Illinois State Operations Center
City of Chicago Emergency Operations Center	incident response coordination	Illinois State Operations Center
City of Chicago Emergency Operations Center	incident report	Municipal EMCs
City of Chicago Emergency Operations Center	incident response coordination	Municipal EMCs
City of Chicago Skyway Operations	road network conditions	City of Chicago 911 Emergency Communications Center
City of Chicago Skyway Operations	incident information	City of Chicago 911 Emergency Communications Center

Source	Flow Name	Destination
City of Chicago Skyway Operations	resource deployment status	City of Chicago 911 Emergency Communications Center
City of Chicago Skyway Operations	maint and constr resource request	City of Chicago DSS Traffic Services Dispatch
City of Chicago Skyway Operations	video surveillance control	City of Chicago Skyway Roadside Equipment
City of Chicago Skyway Operations	incident information	IDOT District 1 ComCenter
City of Chicago Skyway Operations	incident information request	IDOT District 1 ComCenter
City of Chicago Skyway Operations	maint and constr resource request	IDOT District 1 ComCenter
City of Chicago Skyway Operations	resource deployment status	IDOT District 1 ComCenter
City of Chicago Skyway Operations	road network conditions	IDOT District 1 ComCenter
City of Chicago Skyway Operations	traffic information coordination	Illinois Gateway
City of Chicago Skyway Operations	traffic information coordination	Indiana DOT Arterial TMC
City of Chicago Skyway Operations	traffic information coordination	Indiana Toll Road Operations Center
City of Chicago Skyway Roadside Equipment	traffic images	City of Chicago Skyway Operations
Coast Guard Dispatch	incident report	City of Chicago 911 Emergency Communications Center
Coast Guard Dispatch	incident response coordination	City of Chicago 911 Emergency Communications Center
Coast Guard Dispatch	incident report	Cook County Sheriff Communications Center
Coast Guard Dispatch	incident response coordination	Cook County Sheriff Communications Center
Coast Guard Dispatch	incident information	IDOT District 1 ComCenter
Coast Guard Dispatch	incident report	IDOT District 1 ComCenter
Coast Guard Dispatch	incident response coordination	IDOT District 1 ComCenter
Coast Guard Dispatch	incident information	Illinois Gateway
Coast Guard Dispatch	incident report	Illinois State Police Dispatch (Districts 2, 5 and Chicago)
Coast Guard Dispatch	incident response coordination	Illinois State Police Dispatch (Districts 2, 5 and Chicago)
Coast Guard Dispatch	incident report	Lake County Communications Center
Coast Guard Dispatch	incident response coordination	Lake County Communications Center
Coast Guard Dispatch	incident report	Municipal Public Safety Dispatch
Coast Guard Dispatch	incident response coordination	Municipal Public Safety Dispatch
Coast Guard Dispatch	incident report	Will County Sheriff Communications Center
Coast Guard Dispatch	incident response coordination	Will County Sheriff Communications Center
Cook County EOC	incident report	City of Chicago Emergency Operations Center
Cook County EOC	incident response coordination	City of Chicago Emergency Operations Center
Cook County EOC	incident response coordination	Cook County Sheriff Communications Center
Cook County EOC	incident report	DuPage County EOC
Cook County EOC	incident response coordination	DuPage County EOC
Cook County EOC	incident information	IDOT District 1 ComCenter
Cook County EOC	incident report	IDOT District 1 ComCenter
Cook County EOC	incident response coordination	IDOT District 1 ComCenter
Cook County EOC	incident information	Illinois Gateway
Cook County Highway Department Construction Bureau	maint and constr resource coordination	City of Chicago DOT BOS Roadway Maintenance
Cook County Highway Department Construction Bureau	maint and constr resource response	City of Chicago DOT TMC
Cook County Highway Department Construction Bureau	maint and constr resource coordination	IDOT District 1 Bureau of Construction
Cook County Highway Department Construction Bureau	incident information	IDOT District 1 Bureau of Traffic Signal Unit

Source	Flow Name	Destination
Cook County Highway Department Construction Bureau	maint and constr resource response	IDOT District 1 Bureau of Traffic Signal Unit
Cook County Highway Department Construction Bureau	maint and constr resource coordination	IDOT District 1 ComCenter
Cook County Highway Department Construction Bureau	incident information	Illinois Gateway
Cook County Highway Department Construction Bureau	maint and constr resource coordination	Lake County Highway Construction
Cook County Highway Department Maintenance Bureau	maint and constr resource coordination	City of Chicago Bureau of Street Operations Dispatch
Cook County Highway Department Maintenance Bureau	maint and constr resource coordination	City of Chicago DOT BOS Roadway Maintenance
Cook County Highway Department Maintenance Bureau	maint and constr resource response	City of Chicago DOT TMC
Cook County Highway Department Maintenance Bureau	maint and constr resource coordination	City of Chicago DSS BOE Signal Maintenance
Cook County Highway Department Maintenance Bureau	maint and constr resource response	Cook County TMC
Cook County Highway Department Maintenance Bureau	incident information	Cook County TMC
Cook County Highway Department Maintenance Bureau	maint and constr resource coordination	DuPage County Maintenance
Cook County Highway Department Maintenance Bureau	maint and constr resource coordination	IDOT District 1 Bureau of Construction
Cook County Highway Department Maintenance Bureau	incident information	IDOT District 1 Bureau of Traffic Signal Unit
Cook County Highway Department Maintenance Bureau	incident information	IDOT District 1 ComCenter
Cook County Highway Department Maintenance Bureau	maint and constr resource coordination	IDOT District 1 ComCenter
Cook County Highway Department Maintenance Bureau	maint and constr resource response	IDOT District 1 Traffic Systems Center (TSC)
Cook County Highway Department Maintenance Bureau	incident information	IDOT District 1 Traffic Systems Center (TSC)
Cook County Highway Department Maintenance Bureau	incident information	Illinois Gateway
Cook County Highway Department Maintenance Bureau	maint and constr resource response	Illinois State Police Dispatch (Districts 2, 5 and Chicago)
Cook County Highway Department Maintenance Bureau	maint and constr resource coordination	Kane County Maintenance
Cook County Highway Department Maintenance Bureau	maint and constr resource response	Kane County TMC
Cook County Highway Department Maintenance Bureau	incident information	Kane County TMC
Cook County Highway Department Maintenance Bureau	maint and constr resource coordination	Lake County Highway Maintenance
Cook County Highway Department Maintenance Bureau	maint and constr resource response	Lake County TMC
Cook County Highway Department Maintenance Bureau	incident information	Lake County TMC
Cook County Highway Department Maintenance Bureau	incident information	Municipal TMCs
Cook County Highway Department Maintenance Bureau	maint and constr resource response	Satellite TMC OHare Airport
Cook County Highway Department Maintenance Bureau	incident information	Satellite TMC OHare Airport
Cook County Highway Department Maintenance Bureau	maint and constr resource coordination	Will County Maintenance
Cook County Sheriff Communications Center	incident response coordination	City of Chicago 911 Emergency Communications Center
Cook County Sheriff Communications Center	incident report	Coast Guard Dispatch
Cook County Sheriff Communications Center	incident response coordination	Coast Guard Dispatch
Cook County Sheriff Communications Center	incident report	Cook County EOC
Cook County Sheriff Communications Center	incident response coordination	Cook County EOC
Cook County Sheriff Communications Center	incident report	DuPage County EOC
Cook County Sheriff Communications Center	incident response coordination	DuPage County EOC
Cook County Sheriff Communications Center	incident report	DuPage County Sheriff Communications Center
Cook County Sheriff Communications Center	incident response coordination	DuPage County Sheriff Communications Center
Cook County Sheriff Communications Center	incident information	DuPage County TMC
Cook County Sheriff Communications Center	incident information	IDOT District 1 Bureau of Traffic Signal Unit
Cook County Sheriff Communications Center	incident information	IDOT District 1 ComCenter



ATMS08

Source	Flow Name	Destination
Cook County Sheriff Communications Center	incident report	IDOT District 1 ComCenter
Cook County Sheriff Communications Center	incident response coordination	IDOT District 1 ComCenter
Cook County Sheriff Communications Center	resource request	IDOT District 1 ComCenter
Cook County Sheriff Communications Center	incident information	IDOT District 1 Maintenance Management
Cook County Sheriff Communications Center	incident response status	IDOT District 1 Maintenance Management
Cook County Sheriff Communications Center	maint and constr resource request	IDOT District 1 Maintenance Management
Cook County Sheriff Communications Center	resource request	Illinois Gateway
Cook County Sheriff Communications Center	incident report	Illinois State Police Dispatch (Districts 2, 5 and Chicago)
Cook County Sheriff Communications Center	incident response coordination	Illinois State Police Dispatch (Districts 2, 5 and Chicago)
Cook County Sheriff Communications Center	incident report	Kane County 911 Center
Cook County Sheriff Communications Center	incident response coordination	Kane County 911 Center
Cook County Sheriff Communications Center	incident report	Lake County Communications Center
Cook County Sheriff Communications Center	incident response coordination	Lake County Communications Center
Cook County Sheriff Communications Center	incident information	Lake County TMC
Cook County Sheriff Communications Center	resource request	Lake County TMC
Cook County Sheriff Communications Center	incident report	Municipal Public Safety Dispatch
Cook County Sheriff Communications Center	incident response coordination	Municipal Public Safety Dispatch
Cook County Sheriff Communications Center	incident response coordination	Private Tow and Recovery Operations
Cook County Sheriff Communications Center	incident information	Satellite TMC Midway Airport
Cook County Sheriff Communications Center	incident response status	Satellite TMC Midway Airport
Cook County Sheriff Communications Center	resource request	Satellite TMC Midway Airport
Cook County Sheriff Communications Center	incident information	Satellite TMC OHare Airport
Cook County Sheriff Communications Center	incident report	Will County Sheriff Communications Center
Cook County Sheriff Communications Center	incident response coordination	Will County Sheriff Communications Center
Cook County TMC	incident information	City of Chicago DSS BOE Signal Maintenance
Cook County TMC	maint and constr resource request	Cook County Highway Department Maintenance Bureau
Cook County TMC	incident information	Cook County Highway Department Maintenance Bureau
Cook County TMC	maint and constr resource request	IDOT District 1 Maintenance Management
Cook County TMC	incident information	IDOT District 1 Maintenance Management
Cook County TMC	maint and constr resource request	Kane County Maintenance
Cook County TMC	incident information	Kane County Maintenance
Cook County TMC	maint and constr resource request	Lake County Highway Maintenance
Cook County TMC	maint and constr resource request	Private Sector Maintenance Contractor
DuPage Area TMC	traffic information coordination	DuPage County TMC
DuPage Area TMC	traffic information coordination	IDOT District 1 Bureau of Traffic Signal Unit
DuPage Area TMC	traffic information coordination	IDOT District 1 ComCenter
DuPage Area TMC	traffic information coordination	Illinois Gateway
DuPage Area TMC	resource deployment status	Municipal Public Safety Dispatch
DuPage Area TMC	road network conditions	Municipal Public Safety Dispatch
DuPage Area TMC	maint and constr resource request	Municipal/ Township Maintenance
DuPage Area TMC	traffic information coordination	Satellite TMC OHare Airport

ATMS08

Source	Flow Name	Destination
DuPage County EOC	incident report	City of Chicago 911 Emergency Communications Center
DuPage County EOC	incident response coordination	City of Chicago 911 Emergency Communications Center
DuPage County EOC	incident report	City of Chicago Emergency Operations Center
DuPage County EOC	incident response coordination	City of Chicago Emergency Operations Center
DuPage County EOC	incident report	Cook County EOC
DuPage County EOC	incident response coordination	Cook County EOC
DuPage County EOC	incident report	Cook County Sheriff Communications Center
DuPage County EOC	incident response coordination	Cook County Sheriff Communications Center
DuPage County EOC	incident information	DuPage County Maintenance
DuPage County EOC	incident response status	DuPage County Maintenance
DuPage County EOC	maint and constr resource request	DuPage County Maintenance
DuPage County EOC	incident report	DuPage County Sheriff Communications Center
DuPage County EOC	incident response coordination	DuPage County Sheriff Communications Center
DuPage County EOC	incident response status	DuPage County TMC
DuPage County EOC	resource request	DuPage County TMC
DuPage County EOC	incident information	IDOT District 1 ComCenter
DuPage County EOC	incident information	IDOT District 1 Traffic Systems Center (TSC)
DuPage County EOC	incident information	Illinois Gateway
DuPage County EOC	incident response status	Illinois Gateway
DuPage County EOC	resource request	Illinois Gateway
DuPage County EOC	incident report	Illinois State Operations Center
DuPage County EOC	incident response coordination	Illinois State Operations Center
DuPage County EOC	incident response coordination	Illinois State Police Dispatch (Districts 2, 5 and Chicago)
DuPage County EOC	incident report	Illinois State Police District 15 Operations Desk
DuPage County EOC	incident response coordination	Illinois State Police District 15 Operations Desk
DuPage County EOC	incident report	ISTHA Dispatch Center
DuPage County EOC	incident response coordination	ISTHA Dispatch Center
DuPage County EOC	incident report	Kane County 911 Center
DuPage County EOC	incident response coordination	Kane County 911 Center
DuPage County EOC	incident report	Kane County EOC
DuPage County EOC	incident response coordination	Kane County EOC
DuPage County EOC	incident report	Lake County Communications Center
DuPage County EOC	incident response coordination	Lake County Communications Center
DuPage County EOC	incident report	Lake County EOC
DuPage County EOC	incident response coordination	Lake County EOC
DuPage County EOC	incident report	McHenry County EOC
DuPage County EOC	incident response coordination	McHenry County EOC
DuPage County EOC	incident report	McHenry County Sheriff Dispatch
DuPage County EOC	incident response coordination	McHenry County Sheriff Dispatch
DuPage County EOC	incident report	Municipal EMCs
DuPage County EOC	incident response coordination	Municipal EMCs

Source	Flow Name	Destination
DuPage County EOC	incident report	Municipal Public Safety Dispatch
DuPage County EOC	incident response coordination	Municipal Public Safety Dispatch
DuPage County EOC	incident report	Other County 911 Centers
DuPage County EOC	incident response coordination	Other County 911 Centers
DuPage County EOC	incident report	Other County EOCs
DuPage County EOC	incident response coordination	Other County EOCs
DuPage County EOC	incident information	Satellite TMC OHare Airport
DuPage County EOC	incident report	Will County EOC
DuPage County EOC	incident response coordination	Will County EOC
DuPage County EOC	incident report	Will County Sheriff Communications Center
DuPage County EOC	incident response coordination	Will County Sheriff Communications Center
DuPage County EOC	incident report	Wisconsin Municipal Public Safety
DuPage County EOC	incident response coordination	Wisconsin Municipal Public Safety
DuPage County Maintenance	maint and constr resource coordination	Cook County Highway Department Maintenance Bureau
DuPage County Maintenance	incident information	DuPage County EOC
DuPage County Maintenance	maint and constr resource response	DuPage County EOC
DuPage County Maintenance	maint and constr resource response	DuPage County TMC
DuPage County Maintenance	maint and constr resource coordination	IDOT District 1 Bureau of Construction
DuPage County Maintenance	maint and constr resource coordination	IDOT District 1 Bureau of Traffic- Expressway Operations Unit
DuPage County Maintenance	incident information	IDOT District 1 ComCenter
DuPage County Maintenance	maint and constr resource coordination	IDOT District 1 ComCenter
DuPage County Maintenance	maint and constr resource coordination	IDOT District 1 Maintenance Management
DuPage County Maintenance	maint and constr resource response	IDOT District 1 Traffic Systems Center (TSC)
DuPage County Maintenance	incident information	IDOT District 1 Traffic Systems Center (TSC)
DuPage County Maintenance	incident information	Illinois Gateway
DuPage County Maintenance	maint and constr resource response	Illinois State Police Dispatch (Districts 2, 5 and Chicago)
DuPage County Maintenance	maint and constr resource coordination	ISTHA Maintenance and Construction
DuPage County Maintenance	maint and constr resource response	Kane County EOC
DuPage County Maintenance	maint and constr resource coordination	Kane County Maintenance
DuPage County Maintenance	maint and constr resource response	Kane County TMC
DuPage County Maintenance	maint and constr resource response	Municipal TMCs
DuPage County Maintenance	incident information	Municipal TMCs
DuPage County Maintenance	maint and constr resource coordination	Municipal/ Township Maintenance
DuPage County Maintenance	maint and constr resource coordination	Private Sector Maintenance Contractor
DuPage County Maintenance	maint and constr resource coordination	Will County Maintenance
DuPage County Maintenance	incident information	Will County TMC
DuPage County Sheriff Communications Center	incident report	Cook County Sheriff Communications Center
DuPage County Sheriff Communications Center	incident response coordination	Cook County Sheriff Communications Center
DuPage County Sheriff Communications Center	incident report	DuPage County EOC
DuPage County Sheriff Communications Center	incident response coordination	DuPage County EOC
DuPage County Sheriff Communications Center	incident information	IDOT District 1 ComCenter

Source	Flow Name	Destination
DuPage County Sheriff Communications Center	incident report	IDOT District 1 ComCenter
DuPage County Sheriff Communications Center	incident response coordination	IDOT District 1 ComCenter
DuPage County Sheriff Communications Center	incident response status	IDOT District 1 ComCenter
DuPage County Sheriff Communications Center	resource request	IDOT District 1 ComCenter
DuPage County Sheriff Communications Center	incident information	IDOT District 1 Maintenance Management
DuPage County Sheriff Communications Center	incident response status	IDOT District 1 Maintenance Management
DuPage County Sheriff Communications Center	maint and constr resource request	IDOT District 1 Maintenance Management
DuPage County Sheriff Communications Center	resource request	Illinois Gateway
DuPage County Sheriff Communications Center	incident report	Illinois State Police Dispatch (Districts 2, 5 and Chicago)
DuPage County Sheriff Communications Center	incident response coordination	Illinois State Police Dispatch (Districts 2, 5 and Chicago)
DuPage County Sheriff Communications Center	incident report	Kane County 911 Center
DuPage County Sheriff Communications Center	incident response coordination	Kane County 911 Center
DuPage County Sheriff Communications Center	incident report	Municipal Public Safety Dispatch
DuPage County Sheriff Communications Center	incident report	Will County Sheriff Communications Center
DuPage County Sheriff Communications Center	incident response coordination	Will County Sheriff Communications Center
DuPage County TMC	incident information	Cook County Sheriff Communications Center
DuPage County TMC	traffic information coordination	DuPage Area TMC
DuPage County TMC	road network conditions	DuPage County EOC
DuPage County TMC	incident information	DuPage County EOC
DuPage County TMC	resource deployment status	DuPage County EOC
DuPage County TMC	maint and constr resource request	DuPage County Maintenance
DuPage County TMC	road network conditions	DuPage County Sheriff Communications Center
DuPage County TMC	incident information	IDOT District 1 ComCenter
DuPage County TMC	maint and constr resource request	IDOT District 1 ComCenter
DuPage County TMC	resource deployment status	IDOT District 1 ComCenter
DuPage County TMC	maint and constr resource request	IDOT District 1 Maintenance Management
DuPage County TMC	incident information	IDOT District 1 Maintenance Management
DuPage County TMC	incident information	Illinois State Police Dispatch (Districts 2, 5 and Chicago)
DuPage County TMC	resource deployment status	Illinois State Police Dispatch (Districts 2, 5 and Chicago)
DuPage County TMC	road network conditions	Illinois State Police District 15 Operations Desk
DuPage County TMC	incident information	Illinois State Police District 15 Operations Desk
DuPage County TMC	resource deployment status	Illinois State Police District 15 Operations Desk
DuPage County TMC	incident information	Kane County 911 Center
DuPage County TMC	resource deployment status	Kane County 911 Center
DuPage County TMC	road network conditions	Kane County EOC
DuPage County TMC	incident information	Kane County EOC
DuPage County TMC	road network conditions	Municipal EMCs
DuPage County TMC	incident information	Municipal EMCs
DuPage County TMC	incident information	Municipal Public Safety Dispatch
DuPage County TMC	resource deployment status	Municipal Public Safety Dispatch
DuPage County TMC	maint and constr resource request	Municipal/ Township Maintenance

Source	Flow Name	Destination
DuPage County TMC	maint and constr resource request	Private Sector Maintenance Contractor
DuPage County TMC	maint and constr resource request	Utility Company Dispatch
DuPage County TMC	incident information	Will County Maintenance
DuPage County TMC	road network conditions	Will County Sheriff Communications Center
DuPage County TMC	incident information	Will County Sheriff Communications Center
Gateway Central	request for road network conditions	Indiana Gateway
Gateway Central	road network conditions	Indiana Gateway
Gateway Central	road network conditions	Private ISPs - Travel Information Services
Gateway Central	request for road network conditions	Wisconsin Gateway
Gateway Central	road network conditions	Wisconsin Gateway
Great Lakes Training Center	event plans	Lake County Communications Center
Great Lakes Training Center	incident report	Lake County Communications Center
Great Lakes Training Center	incident response coordination	Lake County Communications Center
Great Lakes Training Center	incident report	Lake County EOC
Great Lakes Training Center	incident response coordination	Lake County EOC
Highway Emergency Lane Patrol Vehicles	incident status	ISTHA Dispatch Center
IDOT District 1 Bureau of Construction	maint and constr resource coordination	City of Chicago DOT BOS Roadway Maintenance
IDOT District 1 Bureau of Construction	maint and constr resource coordination	City of Chicago DSS BOE Signal Maintenance
IDOT District 1 Bureau of Construction	maint and constr resource coordination	Cook County Highway Department Construction Bureau
IDOT District 1 Bureau of Construction	maint and constr resource coordination	Cook County Highway Department Maintenance Bureau
IDOT District 1 Bureau of Construction	maint and constr resource coordination	DuPage County Maintenance
IDOT District 1 Bureau of Construction	incident information	IDOT District 1 Bureau of Traffic Signal Unit
IDOT District 1 Bureau of Construction	incident information	IDOT District 1 ComCenter
IDOT District 1 Bureau of Construction	maint and constr resource coordination	IDOT District 1 ComCenter
IDOT District 1 Bureau of Construction	maint and constr resource coordination	IDOT District 1 Maintenance Management
IDOT District 1 Bureau of Construction	incident information	IDOT District 1 Traffic Systems Center (TSC)
IDOT District 1 Bureau of Construction	incident information	Illinois Gateway
IDOT District 1 Bureau of Construction	maint and constr resource response	ISTHA TMC (TIMS)
IDOT District 1 Bureau of Construction	incident information	ISTHA TMC (TIMS)
IDOT District 1 Bureau of Construction	maint and constr resource coordination	Lake County Highway Construction
IDOT District 1 Bureau of Construction	maint and constr resource response	Will County TMC
IDOT District 1 Bureau of Construction	incident information	Will County TMC
IDOT District 1 Bureau of Traffic- Expressway Operations	maint and constr resource coordination	City of Chicago DOT BOS Roadway Maintenance
IDOT District 1 Bureau of Traffic- Expressway Operations	incident information	IDOT District 1 Bureau of Traffic Signal Unit
IDOT District 1 Bureau of Traffic- Expressway Operations	maint and constr resource coordination	IDOT District 1 ComCenter
IDOT District 1 Bureau of Traffic- Expressway Operations	maint and constr resource coordination	IDOT District 1 Maintenance Management
IDOT District 1 Bureau of Traffic- Expressway Operations	incident information	IDOT District 1 Traffic Systems Center (TSC)
IDOT District 1 Bureau of Traffic- Expressway Operations	incident information	Illinois Gateway
IDOT District 1 Bureau of Traffic- Expressway Operations	incident information	ISTHA TMC (TIMS)
IDOT District 1 Bureau of Traffic- Expressway Operations	maint and constr resource coordination	Will County Maintenance
IDOT District 1 Bureau of Traffic- Expressway Operations	incident information	Will County TMC

ATMS08

Source	Flow Name	Destination
IDOT District 1 Bureau of Traffic Signal Unit	maint and constr resource request	City of Chicago DOT BOS Roadway Maintenance
IDOT District 1 Bureau of Traffic Signal Unit	incident information	City of Chicago DSS BOE Signal Maintenance
IDOT District 1 Bureau of Traffic Signal Unit	maint and constr resource request	City of Chicago DSS BOE Signal Maintenance
IDOT District 1 Bureau of Traffic Signal Unit	incident information	Cook County Highway Department Construction Bureau
IDOT District 1 Bureau of Traffic Signal Unit	maint and constr resource request	Cook County Highway Department Construction Bureau
IDOT District 1 Bureau of Traffic Signal Unit	maint and constr resource request	Cook County Highway Department Maintenance Bureau
IDOT District 1 Bureau of Traffic Signal Unit	incident information	Cook County Highway Department Maintenance Bureau
IDOT District 1 Bureau of Traffic Signal Unit	incident information	Cook County Sheriff Communications Center
IDOT District 1 Bureau of Traffic Signal Unit	road network conditions	Cook County Sheriff Communications Center
IDOT District 1 Bureau of Traffic Signal Unit	traffic information coordination	DuPage Area TMC
IDOT District 1 Bureau of Traffic Signal Unit	incident information	IDOT District 1 Bureau of Construction
IDOT District 1 Bureau of Traffic Signal Unit	incident information	IDOT District 1 Bureau of Traffic- Expressway Operations Unit
IDOT District 1 Bureau of Traffic Signal Unit	road network conditions	IDOT District 1 ComCenter
IDOT District 1 Bureau of Traffic Signal Unit	incident information	IDOT District 1 Maintenance Management
IDOT District 1 Bureau of Traffic Signal Unit	maint and constr resource request	ISTHA Maintenance and Construction
IDOT District 1 Bureau of Traffic Signal Unit	incident information	ISTHA Maintenance and Construction
IDOT District 1 Bureau of Traffic Signal Unit	incident information	Kane County 911 Center
IDOT District 1 Bureau of Traffic Signal Unit	maint and constr resource request	Kane County Maintenance
IDOT District 1 Bureau of Traffic Signal Unit	incident information	Kane County Maintenance
IDOT District 1 Bureau of Traffic Signal Unit	incident information	Lake County Communications Center
IDOT District 1 Bureau of Traffic Signal Unit	maint and constr resource request	Lake County Highway Maintenance
IDOT District 1 Bureau of Traffic Signal Unit	incident information	Lake County Highway Maintenance
IDOT District 1 Bureau of Traffic Signal Unit	maint and constr resource request	McHenry County Maintenance
IDOT District 1 Bureau of Traffic Signal Unit	incident information	McHenry County Maintenance
IDOT District 1 Bureau of Traffic Signal Unit	incident information	McHenry County Sheriff Dispatch
IDOT District 1 Bureau of Traffic Signal Unit	incident information	Municipal/ Township Maintenance
IDOT District 1 Bureau of Traffic Signal Unit	maint and constr resource request	Municipal/ Township Maintenance
IDOT District 1 Bureau of Traffic Signal Unit	maint and constr resource request	Private Sector Maintenance Contractor
IDOT District 1 Bureau of Traffic Signal Unit	traffic information coordination	South Suburban Airport TMC
IDOT District 1 Bureau of Traffic Signal Unit	maint and constr resource request	Will County Maintenance
IDOT District 1 Bureau of Traffic Signal Unit	incident information	Will County Maintenance
IDOT District 1 Bureau of Traffic Signal Unit	incident information	Will County Sheriff Communications Center
IDOT District 1 ComCenter	incident information	Borman Traffic Management Center
IDOT District 1 ComCenter	resource request	Borman Traffic Management Center
IDOT District 1 ComCenter	traffic information coordination	Borman Traffic Management Center
IDOT District 1 ComCenter	road network conditions	City of Chicago 911 Emergency Communications Center
IDOT District 1 ComCenter	resource deployment status	City of Chicago 911 Emergency Communications Center
IDOT District 1 ComCenter	maint and constr resource coordination	City of Chicago Bureau of Street Operations Dispatch
IDOT District 1 ComCenter	incident information	City of Chicago DOT BOS Roadway Maintenance
IDOT District 1 ComCenter	maint and constr resource coordination	City of Chicago DOT BOS Roadway Maintenance
IDOT District 1 ComCenter	maint and constr resource response	City of Chicago DOT TMC

ATMS08

Source	Flow Name	Destination
IDOT District 1 ComCenter	resource request	City of Chicago DOT TMC
IDOT District 1 ComCenter	incident information	City of Chicago DSS BOE Signal Maintenance
IDOT District 1 ComCenter	maint and constr resource coordination	City of Chicago DSS BOE Signal Maintenance
IDOT District 1 ComCenter	maint and constr resource coordination	City of Chicago DSS Traffic Services Dispatch
IDOT District 1 ComCenter	incident report	City of Chicago Emergency Operations Center
IDOT District 1 ComCenter	incident response coordination	City of Chicago Emergency Operations Center
IDOT District 1 ComCenter	incident information	City of Chicago Skyway Operations
IDOT District 1 ComCenter	incident response status	City of Chicago Skyway Operations
IDOT District 1 ComCenter	maint and constr resource response	City of Chicago Skyway Operations
IDOT District 1 ComCenter	resource request	City of Chicago Skyway Operations
IDOT District 1 ComCenter	incident information	Coast Guard Dispatch
IDOT District 1 ComCenter	incident report	Coast Guard Dispatch
IDOT District 1 ComCenter	incident response coordination	Coast Guard Dispatch
IDOT District 1 ComCenter	incident information	Cook County EOC
IDOT District 1 ComCenter	incident report	Cook County EOC
IDOT District 1 ComCenter	incident response coordination	Cook County EOC
IDOT District 1 ComCenter	maint and constr resource coordination	Cook County Highway Department Construction Bureau
IDOT District 1 ComCenter	incident information	Cook County Highway Department Maintenance Bureau
IDOT District 1 ComCenter	maint and constr resource coordination	Cook County Highway Department Maintenance Bureau
IDOT District 1 ComCenter	incident information	Cook County Sheriff Communications Center
IDOT District 1 ComCenter	incident report	Cook County Sheriff Communications Center
IDOT District 1 ComCenter	incident response coordination	Cook County Sheriff Communications Center
IDOT District 1 ComCenter	resource deployment status	Cook County Sheriff Communications Center
IDOT District 1 ComCenter	traffic information coordination	DuPage Area TMC
IDOT District 1 ComCenter	incident information	DuPage County EOC
IDOT District 1 ComCenter	incident information	DuPage County Maintenance
IDOT District 1 ComCenter	maint and constr resource coordination	DuPage County Maintenance
IDOT District 1 ComCenter	incident information	DuPage County Sheriff Communications Center
IDOT District 1 ComCenter	incident report	DuPage County Sheriff Communications Center
IDOT District 1 ComCenter	incident response coordination	DuPage County Sheriff Communications Center
IDOT District 1 ComCenter	resource deployment status	DuPage County Sheriff Communications Center
IDOT District 1 ComCenter	road network conditions	DuPage County Sheriff Communications Center
IDOT District 1 ComCenter	incident information	DuPage County TMC
IDOT District 1 ComCenter	maint and constr resource response	DuPage County TMC
IDOT District 1 ComCenter	incident information	IDOT District 1 Bureau of Construction
IDOT District 1 ComCenter	maint and constr resource coordination	IDOT District 1 Bureau of Construction
IDOT District 1 ComCenter	maint and constr resource coordination	IDOT District 1 Bureau of Traffic- Expressway Operations Unit
IDOT District 1 ComCenter	remote surveillance control	IDOT District 1 Bureau of Traffic Signal Unit
IDOT District 1 ComCenter	incident information	IDOT District 1 Maintenance Management
IDOT District 1 ComCenter	maint and constr resource coordination	IDOT District 1 Maintenance Management
IDOT District 1 ComCenter	road network conditions	Illinois DOT Info

Source	Flow Name	Destination
IDOT District 1 ComCenter	road network conditions	Illinois Gateway
IDOT District 1 ComCenter	incident information	Illinois State Operations Center
IDOT District 1 ComCenter	incident report	Illinois State Operations Center
IDOT District 1 ComCenter	incident response coordination	Illinois State Operations Center
IDOT District 1 ComCenter	incident information	Illinois State Police District 15 Operations Desk
IDOT District 1 ComCenter	maint and constr resource response	Illinois State Police District 15 Operations Desk
IDOT District 1 ComCenter	incident report	Indiana County/ Municipal Public Safety Dispatch
IDOT District 1 ComCenter	incident response coordination	Indiana County/ Municipal Public Safety Dispatch
IDOT District 1 ComCenter	incident report	Indiana State Police Dispatch
IDOT District 1 ComCenter	incident response coordination	Indiana State Police Dispatch
IDOT District 1 ComCenter	incident information	ISTHA Dispatch Center
IDOT District 1 ComCenter	incident information	ISTHA Maintenance and Construction
IDOT District 1 ComCenter	maint and constr resource coordination	ISTHA Maintenance and Construction
IDOT District 1 ComCenter	request for road network conditions	ISTHA TMC (TIMS)
IDOT District 1 ComCenter	resource request	ISTHA TMC (TIMS)
IDOT District 1 ComCenter	road network conditions	ISTHA TMC (TIMS)
IDOT District 1 ComCenter	maint and constr resource response	ISTHA TMC (TIMS)
IDOT District 1 ComCenter	incident information	Kane County 911 Center
IDOT District 1 ComCenter	incident report	Kane County 911 Center
IDOT District 1 ComCenter	incident response coordination	Kane County 911 Center
IDOT District 1 ComCenter	resource deployment status	Kane County 911 Center
IDOT District 1 ComCenter	incident information	Kane County EOC
IDOT District 1 ComCenter	incident information	Kane County Maintenance
IDOT District 1 ComCenter	maint and constr resource coordination	Kane County Maintenance
IDOT District 1 ComCenter	incident information	Lake County Communications Center
IDOT District 1 ComCenter	incident report	Lake County Communications Center
IDOT District 1 ComCenter	incident response coordination	Lake County Communications Center
IDOT District 1 ComCenter	resource deployment status	Lake County Communications Center
IDOT District 1 ComCenter	incident information	Lake County EOC
IDOT District 1 ComCenter	incident report	Lake County EOC
IDOT District 1 ComCenter	incident response coordination	Lake County EOC
IDOT District 1 ComCenter	maint and constr resource coordination	Lake County Highway Construction
IDOT District 1 ComCenter	incident information	Lake County Highway Maintenance
IDOT District 1 ComCenter	maint and constr resource coordination	Lake County Highway Maintenance
IDOT District 1 ComCenter	incident information	Lake County TMC
IDOT District 1 ComCenter	resource request	Lake County TMC
IDOT District 1 ComCenter	incident information	McHenry County EOC
IDOT District 1 ComCenter	incident information	McHenry County Maintenance
IDOT District 1 ComCenter	maint and constr resource coordination	McHenry County Maintenance
IDOT District 1 ComCenter	incident information	McHenry County Sheriff Dispatch
IDOT District 1 ComCenter	incident report	McHenry County Sheriff Dispatch



Source	Flow Name	Destination
IDOT District 1 ComCenter	incident response coordination	McHenry County Sheriff Dispatch
IDOT District 1 ComCenter	resource deployment status	McHenry County Sheriff Dispatch
IDOT District 1 ComCenter	incident information	Municipal EMCs
IDOT District 1 ComCenter	incident information	Municipal Public Safety Dispatch
IDOT District 1 ComCenter	resource deployment status	Municipal Public Safety Dispatch
IDOT District 1 ComCenter	incident information	Municipal/ Township Maintenance
IDOT District 1 ComCenter	maint and constr resource coordination	Municipal/ Township Maintenance
IDOT District 1 ComCenter	incident information	Private ISPs - Travel Information Services
IDOT District 1 ComCenter	maint and constr resource coordination	Private Sector Maintenance Contractor
IDOT District 1 ComCenter	incident information	Satellite TMC Midway Airport
IDOT District 1 ComCenter	incident response status	Satellite TMC Midway Airport
IDOT District 1 ComCenter	incident information	South Suburban Airport TMC
IDOT District 1 ComCenter	traffic information coordination	South Suburban Airport TMC
IDOT District 1 ComCenter	maint and constr resource coordination	Utility Company Dispatch
IDOT District 1 ComCenter	incident information	Will County EOC
IDOT District 1 ComCenter	incident information	Will County Maintenance
IDOT District 1 ComCenter	maint and constr resource coordination	Will County Maintenance
IDOT District 1 ComCenter	incident information	Will County Sheriff Communications Center
IDOT District 1 ComCenter	resource deployment status	Will County Sheriff Communications Center
IDOT District 1 ComCenter	incident information	WsDOT District 2 Traffic Operations Center
IDOT District 1 ComCenter	traffic information coordination	WsDOT District 2 Traffic Operations Center
IDOT District 1 Maintenance Management	maint and constr resource coordination	City of Chicago Bureau of Street Operations Dispatch
IDOT District 1 Maintenance Management	maint and constr resource coordination	City of Chicago DOT BOS Roadway Maintenance
IDOT District 1 Maintenance Management	maint and constr resource response	City of Chicago DOT TMC
IDOT District 1 Maintenance Management	maint and constr resource coordination	City of Chicago DSS BOE Signal Maintenance
IDOT District 1 Maintenance Management	maint and constr resource coordination	Cook County Highway Department Maintenance Bureau
IDOT District 1 Maintenance Management	incident information	Cook County Sheriff Communications Center
IDOT District 1 Maintenance Management	maint and constr resource response	Cook County Sheriff Communications Center
IDOT District 1 Maintenance Management	maint and constr resource response	Cook County TMC
IDOT District 1 Maintenance Management	incident information	Cook County TMC
IDOT District 1 Maintenance Management	maint and constr resource coordination	DuPage County Maintenance
IDOT District 1 Maintenance Management	incident information	DuPage County Sheriff Communications Center
IDOT District 1 Maintenance Management	maint and constr resource response	DuPage County Sheriff Communications Center
IDOT District 1 Maintenance Management	maint and constr resource response	DuPage County TMC
IDOT District 1 Maintenance Management	incident information	DuPage County TMC
IDOT District 1 Maintenance Management	maint and constr resource coordination	IDOT District 1 Bureau of Construction
IDOT District 1 Maintenance Management	maint and constr resource coordination	IDOT District 1 Bureau of Traffic- Expressway Operations Unit
IDOT District 1 Maintenance Management	incident information	IDOT District 1 Bureau of Traffic Signal Unit
IDOT District 1 Maintenance Management	incident information	IDOT District 1 ComCenter
IDOT District 1 Maintenance Management	maint and constr resource coordination	IDOT District 1 ComCenter
IDOT District 1 Maintenance Management	incident information	IDOT District 1 Traffic Systems Center (TSC)

Source	Flow Name	Destination
IDOT District 1 Maintenance Management	incident information	Illinois State Police Dispatch (Districts 2, 5 and Chicago)
IDOT District 1 Maintenance Management	maint and constr resource response	Illinois State Police Dispatch (Districts 2, 5 and Chicago)
IDOT District 1 Maintenance Management	maint and constr resource response	Illinois State Police District 15 Operations Desk
IDOT District 1 Maintenance Management	maint and constr resource coordination	ISTHA Maintenance and Construction
IDOT District 1 Maintenance Management	maint and constr resource response	ISTHA TMC (TIMS)
IDOT District 1 Maintenance Management	incident information	ISTHA TMC (TIMS)
IDOT District 1 Maintenance Management	incident information	Kane County 911 Center
IDOT District 1 Maintenance Management	maint and constr resource coordination	Kane County Maintenance
IDOT District 1 Maintenance Management	incident information	Lake County Communications Center
IDOT District 1 Maintenance Management	maint and constr resource coordination	Lake County Highway Maintenance
IDOT District 1 Maintenance Management	maint and constr resource response	Lake County TMC
IDOT District 1 Maintenance Management	incident information	Lake County TMC
IDOT District 1 Maintenance Management	maint and constr resource coordination	McHenry County Maintenance
IDOT District 1 Maintenance Management	incident information	Municipal Public Safety Dispatch
IDOT District 1 Maintenance Management	maint and constr resource response	Municipal Public Safety Dispatch
IDOT District 1 Maintenance Management	maint and constr resource coordination	Private Sector Maintenance Contractor
IDOT District 1 Maintenance Management	maint and constr resource coordination	Will County Maintenance
IDOT District 1 Maintenance Management	incident information	Will County Sheriff Communications Center
IDOT District 1 Maintenance Management	maint and constr resource response	Will County TMC
IDOT District 1 Maintenance Management	incident information	Will County TMC
IDOT District 1 Traffic Systems Center (TSC)	incident information request	*999 Cellular Express Line
IDOT District 1 Traffic Systems Center (TSC)	road network conditions	City of Chicago 911 Emergency Communications Center
IDOT District 1 Traffic Systems Center (TSC)	incident information	City of Chicago 911 Emergency Communications Center
IDOT District 1 Traffic Systems Center (TSC)	incident information request	City of Chicago 911 Emergency Communications Center
IDOT District 1 Traffic Systems Center (TSC)	resource deployment status	City of Chicago 911 Emergency Communications Center
IDOT District 1 Traffic Systems Center (TSC)	request for road network conditions	City of Chicago DOT TMC
IDOT District 1 Traffic Systems Center (TSC)	road network conditions	City of Chicago DOT Transportation Website
IDOT District 1 Traffic Systems Center (TSC)	maint and constr resource request	Cook County Highway Department Maintenance Bureau
IDOT District 1 Traffic Systems Center (TSC)	incident information	Cook County Highway Department Maintenance Bureau
IDOT District 1 Traffic Systems Center (TSC)	maint and constr resource request	DuPage County Maintenance
IDOT District 1 Traffic Systems Center (TSC)	incident information	DuPage County Maintenance
IDOT District 1 Traffic Systems Center (TSC)	incident information	IDOT District 1 Bureau of Traffic- Expressway Operations Unit
IDOT District 1 Traffic Systems Center (TSC)	incident information	IDOT District 1 Maintenance Management
IDOT District 1 Traffic Systems Center (TSC)	road network conditions	Illinois DOT Info
IDOT District 1 Traffic Systems Center (TSC)	road network conditions	ISTHA Dispatch Center
IDOT District 1 Traffic Systems Center (TSC)	incident information	ISTHA Dispatch Center
IDOT District 1 Traffic Systems Center (TSC)	incident information request	ISTHA Dispatch Center
IDOT District 1 Traffic Systems Center (TSC)	resource deployment status	ISTHA Dispatch Center
IDOT District 1 Traffic Systems Center (TSC)	maint and constr resource request	ISTHA Maintenance and Construction
IDOT District 1 Traffic Systems Center (TSC)	incident information	ISTHA Maintenance and Construction
IDOT District 1 Traffic Systems Center (TSC)	traffic information coordination	Lake County TMC

Source	Flow Name	Destination
IDOT District 1 Traffic Systems Center (TSC)	road network conditions	Private ISPs - Travel Information Services
IDOT District 1 Traffic Systems Center (TSC)	traffic information coordination	Satellite TMC Midway Airport
IDOT District 1 Traffic Systems Center (TSC)	traffic information coordination	WsDOT District 2 Traffic Operations Center
IDOT Emergency Traffic Patrol (ETP)	incident report	City of Chicago 911 Emergency Communications Center
IDOT Emergency Traffic Patrol (ETP)	incident response coordination	City of Chicago 911 Emergency Communications Center
IDOT Emergency Traffic Patrol (ETP)	remote surveillance control	IDOT District 1 ComCenter
IDOT Emergency Traffic Patrol (ETP)	resource request	Illinois Gateway
Illinois DOT Info	request for road network conditions	IDOT District 1 ComCenter
Illinois DOT Info	request for road network conditions	IDOT District 1 Traffic Systems Center (TSC)
Illinois Gateway	incident information	City of Chicago DOT BOS Roadway Maintenance
Illinois Gateway	request for road network conditions	City of Chicago DOT TMC
Illinois Gateway	incident information	City of Chicago DSS BOE Signal Maintenance
Illinois Gateway	incident information	City of Chicago Emergency Operations Center
Illinois Gateway	resource deployment status	City of Chicago Emergency Operations Center
Illinois Gateway	traffic information coordination	City of Chicago Skyway Operations
Illinois Gateway	request for road network conditions	City of Chicago Skyway Operations
Illinois Gateway	incident information	Coast Guard Dispatch
Illinois Gateway	incident information	Cook County EOC
Illinois Gateway	incident information	Cook County Highway Department Construction Bureau
Illinois Gateway	incident information	Cook County Highway Department Maintenance Bureau
Illinois Gateway	resource deployment status	Cook County Sheriff Communications Center
Illinois Gateway	road network conditions	Cook County Sheriff Communications Center
Illinois Gateway	traffic information coordination	DuPage Area TMC
Illinois Gateway	road network conditions	DuPage County EOC
Illinois Gateway	incident information	DuPage County EOC
Illinois Gateway	incident information request	DuPage County EOC
Illinois Gateway	resource deployment status	DuPage County EOC
Illinois Gateway	incident information	DuPage County Maintenance
Illinois Gateway	resource deployment status	DuPage County Sheriff Communications Center
Illinois Gateway	incident information	IDOT District 1 Bureau of Construction
Illinois Gateway	incident information	IDOT District 1 Bureau of Traffic- Expressway Operations Unit
Illinois Gateway	resource deployment status	IDOT District 1 ComCenter
Illinois Gateway	request for road network conditions	IDOT District 1 ComCenter
Illinois Gateway	incident information	IDOT District 1 Maintenance Management
Illinois Gateway	road network conditions	IDOT Emergency Traffic Patrol (ETP)
Illinois Gateway	resource deployment status	IDOT Emergency Traffic Patrol (ETP)
Illinois Gateway	incident information	Illinois State Operations Center
Illinois Gateway	resource deployment status	Illinois State Operations Center
Illinois Gateway	incident information	ISTHA Dispatch Center
Illinois Gateway	resource deployment status	ISTHA Dispatch Center
Illinois Gateway	incident information	ISTHA Maintenance and Construction

Source	Flow Name	Destination
Illinois Gateway	incident information	Kane County 911 Center
Illinois Gateway	resource deployment status	Kane County 911 Center
Illinois Gateway	incident information	Kane County EOC
Illinois Gateway	incident information request	Kane County EOC
Illinois Gateway	resource deployment status	Kane County EOC
Illinois Gateway	incident information	Kane County Maintenance
Illinois Gateway	incident information	Lake County Communications Center
Illinois Gateway	resource deployment status	Lake County Communications Center
Illinois Gateway	incident information	Lake County EOC
Illinois Gateway	incident information	Lake County Highway Maintenance
Illinois Gateway	road network conditions	McHenry County EOC
Illinois Gateway	incident information	McHenry County EOC
Illinois Gateway	incident information request	McHenry County EOC
Illinois Gateway	incident information	McHenry County Maintenance
Illinois Gateway	incident information	McHenry County Sheriff Dispatch
Illinois Gateway	resource deployment status	McHenry County Sheriff Dispatch
Illinois Gateway	road network conditions	Municipal EMCs
Illinois Gateway	incident information	Municipal EMCs
Illinois Gateway	incident information request	Municipal EMCs
Illinois Gateway	resource deployment status	Municipal EMCs
Illinois Gateway	road network conditions	Municipal Public Safety Dispatch
Illinois Gateway	incident information	Municipal Public Safety Dispatch
Illinois Gateway	traffic information coordination	Municipal TMCs
Illinois Gateway	incident information	Municipal/ Township Maintenance
Illinois Gateway	traffic information coordination	Satellite TMC Midway Airport
Illinois Gateway	traffic information coordination	South Suburban Airport TMC
Illinois Gateway	road network conditions	Will County EOC
Illinois Gateway	incident information	Will County EOC
Illinois Gateway	incident information request	Will County EOC
Illinois Gateway	resource deployment status	Will County EOC
Illinois Gateway	incident information	Will County Maintenance
Illinois Gateway	road network conditions	Will County Sheriff Communications Center
Illinois Gateway	incident information	Will County Sheriff Communications Center
Illinois Gateway	incident information request	Will County Sheriff Communications Center
Illinois Gateway	resource deployment status	Will County Sheriff Communications Center
Illinois State Operations Center	incident report	City of Chicago Emergency Operations Center
Illinois State Operations Center	incident response coordination	City of Chicago Emergency Operations Center
Illinois State Operations Center	incident report	DuPage County EOC
Illinois State Operations Center	incident response coordination	DuPage County EOC
Illinois State Operations Center	incident information	IDOT District 1 ComCenter
Illinois State Operations Center	incident report	IDOT District 1 ComCenter

Source	Flow Name	Destination
Illinois State Operations Center	incident response coordination	IDOT District 1 ComCenter
Illinois State Operations Center	resource request	IDOT District 1 ComCenter
Illinois State Operations Center	incident information	Illinois Gateway
Illinois State Operations Center	resource request	Illinois Gateway
Illinois State Operations Center	incident report	Illinois State Police Dispatch (Districts 2, 5 and Chicago)
Illinois State Operations Center	incident response coordination	Illinois State Police Dispatch (Districts 2, 5 and Chicago)
Illinois State Operations Center	incident report	Illinois State Police District 15 Operations Desk
Illinois State Operations Center	incident response coordination	Illinois State Police District 15 Operations Desk
Illinois State Operations Center	incident report	Kane County EOC
Illinois State Operations Center	incident response coordination	Kane County EOC
Illinois State Police Dispatch (Districts 2, 5 and Chicago)	incident report	*999 Cellular Express Line
Illinois State Police Dispatch (Districts 2, 5 and Chicago)	incident response coordination	*999 Cellular Express Line
Illinois State Police Dispatch (Districts 2, 5 and Chicago)	incident report	Coast Guard Dispatch
Illinois State Police Dispatch (Districts 2, 5 and Chicago)	incident response coordination	Coast Guard Dispatch
Illinois State Police Dispatch (Districts 2, 5 and Chicago)	maint and constr resource request	Cook County Highway Department Maintenance Bureau
Illinois State Police Dispatch (Districts 2, 5 and Chicago)	incident report	Cook County Sheriff Communications Center
Illinois State Police Dispatch (Districts 2, 5 and Chicago)	incident response coordination	Cook County Sheriff Communications Center
Illinois State Police Dispatch (Districts 2, 5 and Chicago)	maint and constr resource request	DuPage County Maintenance
Illinois State Police Dispatch (Districts 2, 5 and Chicago)	incident report	DuPage County Sheriff Communications Center
Illinois State Police Dispatch (Districts 2, 5 and Chicago)	incident response coordination	DuPage County Sheriff Communications Center
Illinois State Police Dispatch (Districts 2, 5 and Chicago)	remote surveillance control	IDOT District 1 ComCenter
Illinois State Police Dispatch (Districts 2, 5 and Chicago)	incident information	IDOT District 1 Maintenance Management
Illinois State Police Dispatch (Districts 2, 5 and Chicago)	incident response status	IDOT District 1 Maintenance Management
Illinois State Police Dispatch (Districts 2, 5 and Chicago)	maint and constr resource request	IDOT District 1 Maintenance Management
Illinois State Police Dispatch (Districts 2, 5 and Chicago)	remote surveillance control	IDOT District 1 Traffic Systems Center (TSC)
Illinois State Police Dispatch (Districts 2, 5 and Chicago)	incident report	Illinois State Operations Center
Illinois State Police Dispatch (Districts 2, 5 and Chicago)	incident response coordination	Illinois State Operations Center
Illinois State Police Dispatch (Districts 2, 5 and Chicago)	incident command information	Illinois State Police Vehicles
Illinois State Police Dispatch (Districts 2, 5 and Chicago)	incident report	Indiana State Police Dispatch
Illinois State Police Dispatch (Districts 2, 5 and Chicago)	incident response coordination	Indiana State Police Dispatch
Illinois State Police Dispatch (Districts 2, 5 and Chicago)	incident report	Kane County 911 Center
Illinois State Police Dispatch (Districts 2, 5 and Chicago)	incident response coordination	Kane County 911 Center
Illinois State Police Dispatch (Districts 2, 5 and Chicago)	incident information	Kane County Maintenance
Illinois State Police Dispatch (Districts 2, 5 and Chicago)	incident response status	Kane County Maintenance
Illinois State Police Dispatch (Districts 2, 5 and Chicago)	maint and constr resource request	Kane County Maintenance
Illinois State Police Dispatch (Districts 2, 5 and Chicago)	incident report	Lake County Communications Center
Illinois State Police Dispatch (Districts 2, 5 and Chicago)	incident response coordination	Lake County Communications Center
Illinois State Police Dispatch (Districts 2, 5 and Chicago)	maint and constr resource request	Lake County Highway Maintenance
Illinois State Police Dispatch (Districts 2, 5 and Chicago)	incident information	Lake County TMC
Illinois State Police Dispatch (Districts 2, 5 and Chicago)	resource request	Lake County TMC
Illinois State Police Dispatch (Districts 2, 5 and Chicago)	maint and constr resource request	McHenry County Maintenance

Source	Flow Name	Destination
Illinois State Police Dispatch (Districts 2, 5 and Chicago)	incident report	McHenry County Sheriff Dispatch
Illinois State Police Dispatch (Districts 2, 5 and Chicago)	incident response coordination	McHenry County Sheriff Dispatch
Illinois State Police Dispatch (Districts 2, 5 and Chicago)	maint and constr resource request	Will County Maintenance
Illinois State Police Dispatch (Districts 2, 5 and Chicago)	incident report	Will County Sheriff Communications Center
Illinois State Police Dispatch (Districts 2, 5 and Chicago)	incident response coordination	Will County Sheriff Communications Center
Illinois State Police Dispatch (Districts 2, 5 and Chicago)	incident report	Wisconsin State Patrol District 2 Dispatch
Illinois State Police Dispatch (Districts 2, 5 and Chicago)	incident response coordination	Wisconsin State Patrol District 2 Dispatch
Illinois State Police District 15 Operations Desk	incident information	Borman Traffic Management Center
Illinois State Police District 15 Operations Desk	incident report	City of Chicago 911 Emergency Communications Center
Illinois State Police District 15 Operations Desk	incident response coordination	City of Chicago 911 Emergency Communications Center
Illinois State Police District 15 Operations Desk	incident report	DuPage County EOC
Illinois State Police District 15 Operations Desk	incident response coordination	DuPage County EOC
Illinois State Police District 15 Operations Desk	incident information	DuPage County TMC
Illinois State Police District 15 Operations Desk	resource request	DuPage County TMC
Illinois State Police District 15 Operations Desk	resource request	IDOT District 1 ComCenter
Illinois State Police District 15 Operations Desk	maint and constr resource request	IDOT District 1 ComCenter
Illinois State Police District 15 Operations Desk	maint and constr resource request	IDOT District 1 Maintenance Management
Illinois State Police District 15 Operations Desk	incident report	Illinois State Operations Center
Illinois State Police District 15 Operations Desk	incident response coordination	Illinois State Operations Center
Illinois State Police District 15 Operations Desk	incident command information	Illinois State Police Vehicles
Illinois State Police District 15 Operations Desk	incident report	Indiana State Police Dispatch
Illinois State Police District 15 Operations Desk	incident response coordination	Indiana State Police Dispatch
Illinois State Police District 15 Operations Desk	maint and constr resource request	ISTHA Maintenance and Construction
Illinois State Police District 15 Operations Desk	incident information	ISTHA TMC (TIMS)
Illinois State Police District 15 Operations Desk	incident response status	ISTHA TMC (TIMS)
Illinois State Police District 15 Operations Desk	resource request	ISTHA TMC (TIMS)
Illinois State Police District 15 Operations Desk	incident report	Kane County 911 Center
Illinois State Police District 15 Operations Desk	incident response coordination	Kane County 911 Center
Illinois State Police District 15 Operations Desk	incident report	Lake County Communications Center
Illinois State Police District 15 Operations Desk	incident response coordination	Lake County Communications Center
Illinois State Police District 15 Operations Desk	incident information	Lake County TMC
Illinois State Police District 15 Operations Desk	resource request	Lake County TMC
Illinois State Police District 15 Operations Desk	incident report	Will County Sheriff Communications Center
Illinois State Police District 15 Operations Desk	incident response coordination	Will County Sheriff Communications Center
Illinois State Police District 15 Operations Desk	incident report	Wisconsin State Patrol District 2 Dispatch
Illinois State Police District 15 Operations Desk	incident response coordination	Wisconsin State Patrol District 2 Dispatch
Illinois State Police Vehicles	incident status	Illinois State Police Dispatch (Districts 2, 5 and Chicago)
Illinois State Police Vehicles	incident status	Illinois State Police District 15 Operations Desk
Indiana County/ Municipal Public Safety Dispatch	incident report	IDOT District 1 ComCenter
Indiana County/ Municipal Public Safety Dispatch	incident response coordination	IDOT District 1 ComCenter
Indiana County/ Municipal Public Safety Dispatch	incident report	Municipal Public Safety Dispatch

Source	Flow Name	Destination
Indiana County/ Municipal Public Safety Dispatch	incident response coordination	Municipal Public Safety Dispatch
Indiana County/ Municipal Public Safety Dispatch	incident report	Will County Sheriff Communications Center
Indiana County/ Municipal Public Safety Dispatch	incident response coordination	Will County Sheriff Communications Center
Indiana County/ Municipal Public Safety Dispatch	incident information	Will County TMC
Indiana County/ Municipal Public Safety Dispatch	resource request	Will County TMC
Indiana DOT Arterial TMC	incident information	City of Chicago 911 Emergency Communications Center
Indiana DOT Arterial TMC	resource deployment status	City of Chicago 911 Emergency Communications Center
Indiana DOT Arterial TMC	traffic information coordination	City of Chicago DOT TMC
Indiana DOT Arterial TMC	incident information	Will County Sheriff Communications Center
Indiana Gateway	request for road network conditions	Gateway Central
Indiana Gateway	road network conditions	Gateway Central
Indiana State Police Dispatch	incident report	City of Chicago 911 Emergency Communications Center
Indiana State Police Dispatch	incident response coordination	City of Chicago 911 Emergency Communications Center
Indiana State Police Dispatch	incident report	IDOT District 1 ComCenter
Indiana State Police Dispatch	incident response coordination	IDOT District 1 ComCenter
Indiana State Police Dispatch	incident report	Illinois State Police Dispatch (Districts 2, 5 and Chicago)
Indiana State Police Dispatch	incident response coordination	Illinois State Police Dispatch (Districts 2, 5 and Chicago)
Indiana State Police Dispatch	incident report	Illinois State Police District 15 Operations Desk
Indiana State Police Dispatch	incident response coordination	Illinois State Police District 15 Operations Desk
Indiana State Police Dispatch	incident report	Will County Sheriff Communications Center
Indiana State Police Dispatch	incident response coordination	Will County Sheriff Communications Center
Indiana Toll Road Operations Center	incident information	City of Chicago 911 Emergency Communications Center
Indiana Toll Road Operations Center	resource deployment status	City of Chicago 911 Emergency Communications Center
Indiana Toll Road Operations Center	road network conditions	City of Chicago 911 Emergency Communications Center
Indiana Toll Road Operations Center	traffic information coordination	City of Chicago DOT TMC
Indiana Toll Road Operations Center	traffic information coordination	City of Chicago Skyway Operations
ISTHA Dispatch Center	incident report	DuPage County EOC
ISTHA Dispatch Center	incident response coordination	DuPage County EOC
ISTHA Dispatch Center	incident command information	Highway Emergency Lane Patrol Vehicles
ISTHA Dispatch Center	incident information	IDOT District 1 ComCenter
ISTHA Dispatch Center	incident response status	IDOT District 1 ComCenter
ISTHA Dispatch Center	resource request	IDOT District 1 ComCenter
ISTHA Dispatch Center	incident information	IDOT District 1 Traffic Systems Center (TSC)
ISTHA Dispatch Center	incident response status	IDOT District 1 Traffic Systems Center (TSC)
ISTHA Dispatch Center	remote surveillance control	IDOT District 1 Traffic Systems Center (TSC)
ISTHA Dispatch Center	resource request	IDOT District 1 Traffic Systems Center (TSC)
ISTHA Dispatch Center	incident information	Illinois Gateway
ISTHA Dispatch Center	resource request	Illinois Gateway
ISTHA Dispatch Center	incident information	ISTHA Maintenance and Construction
ISTHA Dispatch Center	incident response status	ISTHA Maintenance and Construction
ISTHA Dispatch Center	maint and constr resource request	ISTHA Maintenance and Construction

ATMS08

Source	Flow Name	Destination
ISTHA Dispatch Center	incident information	ISTHA TMC (TIMS)
ISTHA Dispatch Center	incident response status	ISTHA TMC (TIMS)
ISTHA Dispatch Center	remote surveillance control	ISTHA TMC (TIMS)
ISTHA Dispatch Center	resource request	ISTHA TMC (TIMS)
ISTHA Dispatch Center	incident report	Kenosha County Public Safety Dispatch
ISTHA Dispatch Center	incident response coordination	Kenosha County Public Safety Dispatch
ISTHA Dispatch Center	incident report	Lake County Communications Center
ISTHA Dispatch Center	incident response coordination	Lake County Communications Center
ISTHA Dispatch Center	incident report	Lake County EOC
ISTHA Dispatch Center	incident response coordination	Lake County EOC
ISTHA Dispatch Center	incident information	Lake County TMC
ISTHA Dispatch Center	incident response status	Lake County TMC
ISTHA Dispatch Center	resource request	Lake County TMC
ISTHA Dispatch Center	incident report	Will County Sheriff Communications Center
ISTHA Dispatch Center	incident response coordination	Will County Sheriff Communications Center
ISTHA Dispatch Center	incident report	Wisconsin State Patrol District 2 Dispatch
ISTHA Dispatch Center	incident response coordination	Wisconsin State Patrol District 2 Dispatch
ISTHA Maintenance and Construction	maint and constr resource coordination	City of Chicago Bureau of Street Operations Dispatch
ISTHA Maintenance and Construction	maint and constr resource coordination	DuPage County Maintenance
ISTHA Maintenance and Construction	maint and constr resource response	IDOT District 1 Bureau of Traffic Signal Unit
ISTHA Maintenance and Construction	incident information	IDOT District 1 Bureau of Traffic Signal Unit
ISTHA Maintenance and Construction	incident information	IDOT District 1 ComCenter
ISTHA Maintenance and Construction	maint and constr resource coordination	IDOT District 1 ComCenter
ISTHA Maintenance and Construction	maint and constr resource coordination	IDOT District 1 Maintenance Management
ISTHA Maintenance and Construction	maint and constr resource response	IDOT District 1 Traffic Systems Center (TSC)
ISTHA Maintenance and Construction	incident information	IDOT District 1 Traffic Systems Center (TSC)
ISTHA Maintenance and Construction	incident information	Illinois Gateway
ISTHA Maintenance and Construction	maint and constr resource response	Illinois State Police District 15 Operations Desk
ISTHA Maintenance and Construction	incident information	ISTHA Dispatch Center
ISTHA Maintenance and Construction	maint and constr resource response	ISTHA Dispatch Center
ISTHA Maintenance and Construction	maint and constr resource coordination	Kenosha County Highway Maintenance
ISTHA Maintenance and Construction	maint and constr resource coordination	Lake County Highway Maintenance
ISTHA Maintenance and Construction	maint and constr resource response	Lake County TMC
ISTHA Maintenance and Construction	incident information	Lake County TMC
ISTHA Maintenance and Construction	maint and constr resource coordination	McHenry County Maintenance
ISTHA Maintenance and Construction	incident information	Will County Sheriff Communications Center
ISTHA Maintenance and Construction	maint and constr resource response	Will County TMC
ISTHA Maintenance and Construction	incident information	Will County TMC
ISTHA TMC (TIMS)	road network conditions	*999 Cellular Express Line
ISTHA TMC (TIMS)	incident information request	*999 Cellular Express Line
ISTHA TMC (TIMS)	traffic information coordination	Borman Traffic Management Center



ATMS08

Source	Flow Name	Destination
ISTHA TMC (TIMS)	maint and constr resource request	IDOT District 1 Bureau of Construction
ISTHA TMC (TIMS)	incident information	IDOT District 1 Bureau of Construction
ISTHA TMC (TIMS)	incident information	IDOT District 1 Bureau of Traffic- Expressway Operations Unit
ISTHA TMC (TIMS)	incident information request	IDOT District 1 ComCenter
ISTHA TMC (TIMS)	resource deployment status	IDOT District 1 ComCenter
ISTHA TMC (TIMS)	maint and constr resource request	IDOT District 1 ComCenter
ISTHA TMC (TIMS)	maint and constr resource request	IDOT District 1 Maintenance Management
ISTHA TMC (TIMS)	incident information	IDOT District 1 Maintenance Management
ISTHA TMC (TIMS)	request for road network conditions	IDOT District 1 Traffic Systems Center (TSC)
ISTHA TMC (TIMS)	request for road network conditions	Illinois Gateway
ISTHA TMC (TIMS)	road network conditions	Illinois State Police District 15 Operations Desk
ISTHA TMC (TIMS)	incident information	Illinois State Police District 15 Operations Desk
ISTHA TMC (TIMS)	resource deployment status	Illinois State Police District 15 Operations Desk
ISTHA TMC (TIMS)	incident information	ISTHA Dispatch Center
ISTHA TMC (TIMS)	incident information request	ISTHA Dispatch Center
ISTHA TMC (TIMS)	resource deployment status	ISTHA Dispatch Center
ISTHA TMC (TIMS)	incident information	Will County Sheriff Communications Center
ISTHA TMC (TIMS)	traffic information coordination	WsDOT District 2 Traffic Operations Center
Kane County 911 Center	incident report	Cook County Sheriff Communications Center
Kane County 911 Center	incident response coordination	Cook County Sheriff Communications Center
Kane County 911 Center	incident report	DuPage County EOC
Kane County 911 Center	incident response coordination	DuPage County EOC
Kane County 911 Center	incident report	DuPage County Sheriff Communications Center
Kane County 911 Center	incident response coordination	DuPage County Sheriff Communications Center
Kane County 911 Center	incident information	DuPage County TMC
Kane County 911 Center	incident response status	DuPage County TMC
Kane County 911 Center	resource request	DuPage County TMC
Kane County 911 Center	incident information	IDOT District 1 Bureau of Traffic Signal Unit
Kane County 911 Center	incident response status	IDOT District 1 Bureau of Traffic Signal Unit
Kane County 911 Center	resource request	IDOT District 1 Bureau of Traffic Signal Unit
Kane County 911 Center	incident information	IDOT District 1 ComCenter
Kane County 911 Center	incident report	IDOT District 1 ComCenter
Kane County 911 Center	incident response coordination	IDOT District 1 ComCenter
Kane County 911 Center	incident response status	IDOT District 1 ComCenter
Kane County 911 Center	resource request	IDOT District 1 ComCenter
Kane County 911 Center	incident information	IDOT District 1 Maintenance Management
Kane County 911 Center	incident information	Illinois Gateway
Kane County 911 Center	resource request	Illinois Gateway
Kane County 911 Center	incident report	Illinois State Police Dispatch (Districts 2, 5 and Chicago)
Kane County 911 Center	incident response coordination	Illinois State Police Dispatch (Districts 2, 5 and Chicago)
Kane County 911 Center	incident report	Illinois State Police District 15 Operations Desk

ATMS08

Source	Flow Name	Destination
Kane County 911 Center	incident response coordination	Illinois State Police District 15 Operations Desk
Kane County 911 Center	incident report	Kane County EOC
Kane County 911 Center	incident response coordination	Kane County EOC
Kane County 911 Center	incident information	Kane County Maintenance
Kane County 911 Center	incident response status	Kane County Maintenance
Kane County 911 Center	incident report	McHenry County Sheriff Dispatch
Kane County 911 Center	incident response coordination	McHenry County Sheriff Dispatch
Kane County 911 Center	incident report	Municipal Public Safety Dispatch
Kane County 911 Center	incident response coordination	Municipal Public Safety Dispatch
Kane County 911 Center	incident report	Other County 911 Centers
Kane County 911 Center	incident response coordination	Other County 911 Centers
Kane County EOC	incident report	DuPage County EOC
Kane County EOC	incident response coordination	DuPage County EOC
Kane County EOC	incident information	DuPage County Maintenance
Kane County EOC	incident response status	DuPage County Maintenance
Kane County EOC	maint and constr resource request	DuPage County Maintenance
Kane County EOC	incident information	DuPage County TMC
Kane County EOC	incident response status	DuPage County TMC
Kane County EOC	incident information	IDOT District 1 ComCenter
Kane County EOC	incident information	Illinois Gateway
Kane County EOC	incident response status	Illinois Gateway
Kane County EOC	resource request	Illinois Gateway
Kane County EOC	incident report	Illinois State Operations Center
Kane County EOC	incident response coordination	Illinois State Operations Center
Kane County EOC	incident report	Illinois State Police Dispatch (Districts 2, 5 and Chicago)
Kane County EOC	incident response coordination	Illinois State Police Dispatch (Districts 2, 5 and Chicago)
Kane County EOC	incident report	Kane County 911 Center
Kane County EOC	incident response coordination	Kane County 911 Center
Kane County EOC	incident information	Kane County Maintenance
Kane County EOC	incident response status	Kane County Maintenance
Kane County EOC	maint and constr resource request	Kane County Maintenance
Kane County EOC	incident report	McHenry County EOC
Kane County EOC	incident response coordination	McHenry County EOC
Kane County EOC	incident information	McHenry County Maintenance
Kane County EOC	incident response status	McHenry County Maintenance
Kane County EOC	incident information	McHenry County TMC
Kane County EOC	incident response status	McHenry County TMC
Kane County EOC	incident report	Municipal EMCs
Kane County EOC	incident response coordination	Municipal EMCs
Kane County EOC	incident report	Municipal Public Safety Dispatch
Kane County EOC	incident response coordination	Municipal Public Safety Dispatch

ATMS08

Source	Flow Name	Destination
Kane County EOC	incident report	Other County EOCs
Kane County EOC	incident response coordination	Other County EOCs
Kane County Maintenance	maint and constr resource coordination	Cook County Highway Department Maintenance Bureau
Kane County Maintenance	maint and constr resource coordination	DuPage County Maintenance
Kane County Maintenance	maint and constr resource response	IDOT District 1 Bureau of Traffic Signal Unit
Kane County Maintenance	incident information	IDOT District 1 Bureau of Traffic Signal Unit
Kane County Maintenance	incident information	IDOT District 1 ComCenter
Kane County Maintenance	maint and constr resource coordination	IDOT District 1 ComCenter
Kane County Maintenance	maint and constr resource coordination	IDOT District 1 Maintenance Management
Kane County Maintenance	incident information	Illinois Gateway
Kane County Maintenance	incident information	Illinois State Police Dispatch (Districts 2, 5 and Chicago)
Kane County Maintenance	maint and constr resource response	Illinois State Police Dispatch (Districts 2, 5 and Chicago)
Kane County Maintenance	incident information	Kane County EOC
Kane County Maintenance	maint and constr resource response	Kane County EOC
Kane County Maintenance	maint and constr resource response	Kane County TMC
Kane County Maintenance	incident information	Kane County TMC
Kane County Maintenance	incident information	McHenry County EOC
Kane County Maintenance	maint and constr resource coordination	McHenry County Maintenance
Kane County Maintenance	maint and constr resource response	Municipal TMCs
Kane County Maintenance	incident information	Municipal TMCs
Kane County Maintenance	maint and constr resource coordination	Municipal/ Township Maintenance
Kane County Maintenance	maint and constr resource coordination	Private Sector Maintenance Contractor
Kane County TMC	maint and constr resource request	Cook County Highway Department Maintenance Bureau
Kane County TMC	incident information	Cook County Highway Department Maintenance Bureau
Kane County TMC	maint and constr resource request	DuPage County Maintenance
Kane County TMC	incident information	DuPage County Maintenance
Kane County TMC	maint and constr resource request	Kane County Maintenance
Kane County TMC	incident information	Kane County Maintenance
Kane County TMC	maint and constr resource request	McHenry County Maintenance
Kane County TMC	incident information	McHenry County Sheriff Dispatch
Kane County TMC	maint and constr resource request	Private Sector Maintenance Contractor
Kenosha County Highway Maintenance	maint and constr resource coordination	ISTHA Maintenance and Construction
Kenosha County Highway Maintenance	maint and constr resource coordination	Lake County Highway Maintenance
Kenosha County Public Safety Dispatch	incident report	ISTHA Dispatch Center
Kenosha County Public Safety Dispatch	incident response coordination	ISTHA Dispatch Center
Kenosha County Public Safety Dispatch	incident report	Lake County Communications Center
Kenosha County Public Safety Dispatch	incident response coordination	Lake County Communications Center
Kenosha County Public Safety Dispatch	incident report	Lake County EOC
Kenosha County Public Safety Dispatch	incident response coordination	Lake County EOC
Kenosha County Public Safety Dispatch	incident information	Lake County TMC
Kenosha County Public Safety Dispatch	incident response status	Lake County TMC

ATMS08

Source	Flow Name	Destination
Kenosha County Public Safety Dispatch	resource request	Lake County TMC
Kenosha County Public Safety Dispatch	incident report	McHenry County Sheriff Dispatch
Kenosha County Public Safety Dispatch	incident report	Municipal Public Safety Dispatch
Kenosha County Public Safety Dispatch	incident response coordination	Municipal Public Safety Dispatch
Lake County Communications Center	incident report	Coast Guard Dispatch
Lake County Communications Center	incident response coordination	Coast Guard Dispatch
Lake County Communications Center	incident report	Cook County Sheriff Communications Center
Lake County Communications Center	incident response coordination	Cook County Sheriff Communications Center
Lake County Communications Center	incident report	DuPage County EOC
Lake County Communications Center	incident response coordination	DuPage County EOC
Lake County Communications Center	event confirmation	Great Lakes Training Center
Lake County Communications Center	incident report	Great Lakes Training Center
Lake County Communications Center	incident response coordination	Great Lakes Training Center
Lake County Communications Center	incident information	IDOT District 1 Bureau of Traffic Signal Unit
Lake County Communications Center	incident information	IDOT District 1 ComCenter
Lake County Communications Center	incident report	IDOT District 1 ComCenter
Lake County Communications Center	incident response coordination	IDOT District 1 ComCenter
Lake County Communications Center	incident response status	IDOT District 1 ComCenter
Lake County Communications Center	resource request	IDOT District 1 ComCenter
Lake County Communications Center	incident information	IDOT District 1 Maintenance Management
Lake County Communications Center	resource request	Illinois Gateway
Lake County Communications Center	incident report	Illinois State Police Dispatch (Districts 2, 5 and Chicago)
Lake County Communications Center	incident response coordination	Illinois State Police Dispatch (Districts 2, 5 and Chicago)
Lake County Communications Center	incident report	Illinois State Police District 15 Operations Desk
Lake County Communications Center	incident response coordination	Illinois State Police District 15 Operations Desk
Lake County Communications Center	incident report	ISTHA Dispatch Center
Lake County Communications Center	incident response coordination	ISTHA Dispatch Center
Lake County Communications Center	incident report	Kenosha County Public Safety Dispatch
Lake County Communications Center	incident response coordination	Kenosha County Public Safety Dispatch
Lake County Communications Center	incident report	Lake County EOC
Lake County Communications Center	incident response coordination	Lake County EOC
Lake County Communications Center	incident information	Lake County Highway Construction
Lake County Communications Center	maint and constr resource request	Lake County Highway Construction
Lake County Communications Center	incident information	Lake County Highway Maintenance
Lake County Communications Center	maint and constr resource request	Lake County Highway Maintenance
Lake County Communications Center	incident report	McHenry County Sheriff Dispatch
Lake County Communications Center	incident response coordination	McHenry County Sheriff Dispatch
Lake County Communications Center	incident information	McHenry County TMC
Lake County Communications Center	incident report	Municipal Public Safety Dispatch
Lake County Communications Center	incident response coordination	Municipal Public Safety Dispatch
Lake County Communications Center	incident information	Municipal TMCs

Source	Flow Name	Destination
Lake County Communications Center	incident information	Municipal/ Township Maintenance
Lake County Communications Center	incident report	Wisconsin Municipal Public Safety
Lake County Communications Center	incident response coordination	Wisconsin Municipal Public Safety
Lake County Communications Center	incident report	Wisconsin State Patrol District 2 Dispatch
Lake County Communications Center	incident response coordination	Wisconsin State Patrol District 2 Dispatch
Lake County EOC	incident report	DuPage County EOC
Lake County EOC	incident response coordination	DuPage County EOC
Lake County EOC	incident report	Great Lakes Training Center
Lake County EOC	incident response coordination	Great Lakes Training Center
Lake County EOC	incident information	IDOT District 1 ComCenter
Lake County EOC	incident report	IDOT District 1 ComCenter
Lake County EOC	incident response coordination	IDOT District 1 ComCenter
Lake County EOC	incident information	Illinois Gateway
Lake County EOC	incident report	ISTHA Dispatch Center
Lake County EOC	incident response coordination	ISTHA Dispatch Center
Lake County EOC	incident report	Kenosha County Public Safety Dispatch
Lake County EOC	incident response coordination	Kenosha County Public Safety Dispatch
Lake County EOC	incident report	Lake County Communications Center
Lake County EOC	incident response coordination	Lake County Communications Center
Lake County EOC	incident report	McHenry County EOC
Lake County EOC	incident response coordination	McHenry County EOC
Lake County Highway Construction	maint and constr resource coordination	Cook County Highway Department Construction Bureau
Lake County Highway Construction	maint and constr resource coordination	IDOT District 1 Bureau of Construction
Lake County Highway Construction	maint and constr resource coordination	IDOT District 1 ComCenter
Lake County Highway Construction	maint and constr resource response	Lake County Communications Center
Lake County Highway Construction	maint and constr resource coordination	Lake County Highway Maintenance
Lake County Highway Construction	maint and constr resource response	Lake County TMC
Lake County Highway Construction	maint and constr resource response	Municipal Public Safety Dispatch
Lake County Highway Maintenance	maint and constr resource coordination	Cook County Highway Department Maintenance Bureau
Lake County Highway Maintenance	maint and constr resource response	IDOT District 1 Bureau of Traffic Signal Unit
Lake County Highway Maintenance	incident information	IDOT District 1 Bureau of Traffic Signal Unit
Lake County Highway Maintenance	incident information	IDOT District 1 ComCenter
Lake County Highway Maintenance	maint and constr resource coordination	IDOT District 1 ComCenter
Lake County Highway Maintenance	maint and constr resource coordination	IDOT District 1 Maintenance Management
Lake County Highway Maintenance	incident information	Illinois Gateway
Lake County Highway Maintenance	maint and constr resource response	Illinois State Police Dispatch (Districts 2, 5 and Chicago)
Lake County Highway Maintenance	maint and constr resource coordination	ISTHA Maintenance and Construction
Lake County Highway Maintenance	maint and constr resource coordination	Kenosha County Highway Maintenance
Lake County Highway Maintenance	incident information	Lake County Communications Center
Lake County Highway Maintenance	maint and constr resource response	Lake County Communications Center
Lake County Highway Maintenance	maint and constr resource coordination	Lake County Highway Construction

ATMS08

Source	Flow Name	Destination
Lake County Highway Maintenance	maint and constr resource response	Lake County TMC
Lake County Highway Maintenance	incident information	Lake County TMC
Lake County Highway Maintenance	maint and constr resource coordination	McHenry County Maintenance
Lake County Highway Maintenance	maint and constr resource response	McHenry County TMC
Lake County Highway Maintenance	incident information	McHenry County TMC
Lake County Highway Maintenance	incident information	Municipal Public Safety Dispatch
Lake County Highway Maintenance	maint and constr resource response	Municipal Public Safety Dispatch
Lake County Highway Maintenance	incident information	Municipal TMCs
Lake County Highway Maintenance	maint and constr resource coordination	Municipal/ Township Maintenance
Lake County Highway Maintenance	maint and constr resource coordination	Private Sector Maintenance Contractor
Lake County TMC	maint and constr resource request	Cook County Highway Department Maintenance Bureau
Lake County TMC	incident information	Cook County Highway Department Maintenance Bureau
Lake County TMC	incident information	Cook County Sheriff Communications Center
Lake County TMC	resource deployment status	Cook County Sheriff Communications Center
Lake County TMC	incident information	IDOT District 1 ComCenter
Lake County TMC	maint and constr resource request	IDOT District 1 ComCenter
Lake County TMC	resource deployment status	IDOT District 1 ComCenter
Lake County TMC	road network conditions	IDOT District 1 ComCenter
Lake County TMC	maint and constr resource request	IDOT District 1 Maintenance Management
Lake County TMC	incident information	IDOT District 1 Maintenance Management
Lake County TMC	traffic information coordination	IDOT District 1 Traffic Systems Center (TSC)
Lake County TMC	incident information	Illinois State Police Dispatch (Districts 2, 5 and Chicago)
Lake County TMC	resource deployment status	Illinois State Police Dispatch (Districts 2, 5 and Chicago)
Lake County TMC	incident information	Illinois State Police District 15 Operations Desk
Lake County TMC	resource deployment status	Illinois State Police District 15 Operations Desk
Lake County TMC	incident information	ISTHA Dispatch Center
Lake County TMC	resource deployment status	ISTHA Dispatch Center
Lake County TMC	maint and constr resource request	ISTHA Maintenance and Construction
Lake County TMC	incident information	ISTHA Maintenance and Construction
Lake County TMC	incident information	Kenosha County Public Safety Dispatch
Lake County TMC	resource deployment status	Kenosha County Public Safety Dispatch
Lake County TMC	road network conditions	Kenosha County Public Safety Dispatch
Lake County TMC	incident information	Lake County Highway Construction
Lake County TMC	maint and constr resource request	Lake County Highway Construction
Lake County TMC	maint and constr resource request	Lake County Highway Maintenance
Lake County TMC	incident information	Lake County Highway Maintenance
Lake County TMC	maint and constr resource request	McHenry County Maintenance
Lake County TMC	incident information	McHenry County Maintenance
Lake County TMC	incident information	McHenry County Sheriff Dispatch
Lake County TMC	maint and constr resource request	Private Sector Maintenance Contractor
Lake County TMC	incident information	Wisconsin State Patrol District 2 Dispatch

Source	Flow Name	Destination
Lake County TMC	resource deployment status	Wisconsin State Patrol District 2 Dispatch
Lake County TMC	traffic information coordination	WsDOT District 2 Traffic Operations Center
Mayors Office of Special Events	event plans	Cook County TMC
Mayors Office of Special Events	event plans	IDOT District 1 Bureau of Traffic Signal Unit
Mayors Office of Special Events	event plans	IDOT District 1 ComCenter
Mayors Office of Special Events	event plans	IDOT District 1 Traffic Systems Center (TSC)
Mayors Office of Special Events	event plans	Illinois Gateway
Mayors Office of Special Events	event plans	Illinois State Police Dispatch (Districts 2, 5 and Chicago)
Mayors Office of Special Events	event plans	Illinois State Police District 15 Operations Desk
Mayors Office of Special Events	event plans	ISTHA TMC (TIMS)
McHenry County EOC	incident report	DuPage County EOC
McHenry County EOC	incident response coordination	DuPage County EOC
McHenry County EOC	incident information	IDOT District 1 ComCenter
McHenry County EOC	resource request	IDOT District 1 ComCenter
McHenry County EOC	incident information	Illinois Gateway
McHenry County EOC	incident response status	Illinois Gateway
McHenry County EOC	incident report	Lake County EOC
McHenry County EOC	incident response coordination	Lake County EOC
McHenry County EOC	incident information	McHenry County Maintenance
McHenry County EOC	incident response status	McHenry County Maintenance
McHenry County EOC	maint and constr resource request	McHenry County Maintenance
McHenry County EOC	incident report	McHenry County Sheriff Dispatch
McHenry County EOC	incident report	Other County EOCs
McHenry County EOC	incident response coordination	Other County EOCs
McHenry County EOC	incident report	Wisconsin Municipal Public Safety
McHenry County EOC	incident response coordination	Wisconsin Municipal Public Safety
McHenry County Maintenance	maint and constr resource response	IDOT District 1 Bureau of Traffic Signal Unit
McHenry County Maintenance	incident information	IDOT District 1 Bureau of Traffic Signal Unit
McHenry County Maintenance	incident information	IDOT District 1 ComCenter
McHenry County Maintenance	maint and constr resource coordination	IDOT District 1 ComCenter
McHenry County Maintenance	maint and constr resource coordination	IDOT District 1 Maintenance Management
McHenry County Maintenance	incident information	Illinois Gateway
McHenry County Maintenance	maint and constr resource response	Illinois State Police Dispatch (Districts 2, 5 and Chicago)
McHenry County Maintenance	maint and constr resource coordination	Lake County Highway Maintenance
McHenry County Maintenance	maint and constr resource response	Lake County TMC
McHenry County Maintenance	incident information	Lake County TMC
McHenry County Maintenance	maint and constr resource response	McHenry County EOC
McHenry County Maintenance	maint and constr resource response	McHenry County TMC
McHenry County Maintenance	incident information	McHenry County TMC
McHenry County Maintenance	incident information	Municipal TMCs
McHenry County Sheriff Dispatch	incident report	DuPage County EOC

Source	Flow Name	Destination
McHenry County Sheriff Dispatch	incident response coordination	DuPage County EOC
McHenry County Sheriff Dispatch	incident information	IDOT District 1 ComCenter
McHenry County Sheriff Dispatch	incident report	IDOT District 1 ComCenter
McHenry County Sheriff Dispatch	incident response coordination	IDOT District 1 ComCenter
McHenry County Sheriff Dispatch	resource request	IDOT District 1 ComCenter
McHenry County Sheriff Dispatch	incident information	Illinois Gateway
McHenry County Sheriff Dispatch	resource request	Illinois Gateway
McHenry County Sheriff Dispatch	incident report	Illinois State Police Dispatch (Districts 2, 5 and Chicago)
McHenry County Sheriff Dispatch	incident response coordination	Illinois State Police Dispatch (Districts 2, 5 and Chicago)
McHenry County Sheriff Dispatch	incident report	Kane County 911 Center
McHenry County Sheriff Dispatch	incident response coordination	Kane County 911 Center
McHenry County Sheriff Dispatch	incident information	Kane County TMC
McHenry County Sheriff Dispatch	incident report	Kenosha County Public Safety Dispatch
McHenry County Sheriff Dispatch	incident report	Lake County Communications Center
McHenry County Sheriff Dispatch	incident response coordination	Lake County Communications Center
McHenry County Sheriff Dispatch	incident information	Lake County TMC
McHenry County Sheriff Dispatch	incident response status	Lake County TMC
McHenry County Sheriff Dispatch	resource request	Lake County TMC
McHenry County Sheriff Dispatch	incident report	McHenry County EOC
McHenry County Sheriff Dispatch	incident response coordination	McHenry County EOC
McHenry County Sheriff Dispatch	incident information	McHenry County Maintenance
McHenry County Sheriff Dispatch	incident report	Other County 911 Centers
McHenry County Sheriff Dispatch	incident response coordination	Other County 911 Centers
McHenry County TMC	incident information	Lake County Communications Center
McHenry County TMC	maint and constr resource request	Lake County Highway Maintenance
McHenry County TMC	maint and constr resource request	McHenry County Maintenance
McHenry County TMC	incident information	McHenry County Maintenance
McHenry County TMC	maint and constr resource request	Private Sector Maintenance Contractor
Media	external reports	City of Chicago DOT TMC
Metra Consolidated Control Facility	railroad advisories	City of Chicago DOT TMC
Metra Consolidated Control Facility	railroad schedules	City of Chicago DOT TMC
Metra Consolidated Control Facility	railroad advisories	IDOT District 1 Traffic Systems Center (TSC)
Metra Consolidated Control Facility	railroad schedules	IDOT District 1 Traffic Systems Center (TSC)
Municipal EMCs	incident report	City of Chicago Emergency Operations Center
Municipal EMCs	incident response coordination	City of Chicago Emergency Operations Center
Municipal EMCs	incident report	DuPage County EOC
Municipal EMCs	incident response coordination	DuPage County EOC
Municipal EMCs	incident information	IDOT District 1 ComCenter
Municipal EMCs	incident information	Illinois Gateway
Municipal EMCs	incident response status	Illinois Gateway
Municipal EMCs	resource request	Illinois Gateway



Source	Flow Name	Destination
Municipal EMCs	incident report	Illinois State Police Dispatch (Districts 2, 5 and Chicago)
Municipal EMCs	incident response coordination	Illinois State Police Dispatch (Districts 2, 5 and Chicago)
Municipal EMCs	incident report	Kane County EOC
Municipal EMCs	incident response coordination	Kane County EOC
Municipal EMCs	incident report	McHenry County EOC
Municipal EMCs	incident response coordination	McHenry County EOC
Municipal EMCs	incident information	Municipal TMCs
Municipal EMCs	incident response status	Municipal TMCs
Municipal EMCs	resource request	Municipal TMCs
Municipal Public Safety Dispatch	incident report	City of Chicago 911 Emergency Communications Center
Municipal Public Safety Dispatch	incident response coordination	City of Chicago 911 Emergency Communications Center
Municipal Public Safety Dispatch	incident report	Coast Guard Dispatch
Municipal Public Safety Dispatch	incident response coordination	Coast Guard Dispatch
Municipal Public Safety Dispatch	incident report	Cook County Sheriff Communications Center
Municipal Public Safety Dispatch	incident response coordination	Cook County Sheriff Communications Center
Municipal Public Safety Dispatch	incident information	DuPage Area TMC
Municipal Public Safety Dispatch	resource request	DuPage Area TMC
Municipal Public Safety Dispatch	incident report	DuPage County EOC
Municipal Public Safety Dispatch	incident response coordination	DuPage County EOC
Municipal Public Safety Dispatch	resource request	DuPage County TMC
Municipal Public Safety Dispatch	incident information	IDOT District 1 ComCenter
Municipal Public Safety Dispatch	resource request	IDOT District 1 ComCenter
Municipal Public Safety Dispatch	incident information	IDOT District 1 Maintenance Management
Municipal Public Safety Dispatch	incident response status	IDOT District 1 Maintenance Management
Municipal Public Safety Dispatch	maint and constr resource request	IDOT District 1 Maintenance Management
Municipal Public Safety Dispatch	incident information	Illinois Gateway
Municipal Public Safety Dispatch	incident response status	Illinois Gateway
Municipal Public Safety Dispatch	incident report	Illinois State Police Dispatch (Districts 2, 5 and Chicago)
Municipal Public Safety Dispatch	incident response coordination	Illinois State Police Dispatch (Districts 2, 5 and Chicago)
Municipal Public Safety Dispatch	incident report	Indiana County/ Municipal Public Safety Dispatch
Municipal Public Safety Dispatch	incident response coordination	Indiana County/ Municipal Public Safety Dispatch
Municipal Public Safety Dispatch	incident report	Kane County 911 Center
Municipal Public Safety Dispatch	incident response coordination	Kane County 911 Center
Municipal Public Safety Dispatch	incident report	Kane County EOC
Municipal Public Safety Dispatch	incident response coordination	Kane County EOC
Municipal Public Safety Dispatch	incident report	Kenosha County Public Safety Dispatch
Municipal Public Safety Dispatch	incident response coordination	Kenosha County Public Safety Dispatch
Municipal Public Safety Dispatch	incident report	Lake County Communications Center
Municipal Public Safety Dispatch	incident response coordination	Lake County Communications Center
Municipal Public Safety Dispatch	incident information	Lake County Highway Construction
Municipal Public Safety Dispatch	maint and constr resource request	Lake County Highway Construction

ATMS08

Source	Flow Name	Destination
Municipal Public Safety Dispatch	incident report	McHenry County EOC
Municipal Public Safety Dispatch	incident response coordination	McHenry County EOC
Municipal Public Safety Dispatch	incident information	Municipal TMCs
Municipal Public Safety Dispatch	incident response status	Municipal TMCs
Municipal Public Safety Dispatch	resource request	Municipal TMCs
Municipal Public Safety Dispatch	incident report	Will County EOC
Municipal Public Safety Dispatch	incident response coordination	Will County EOC
Municipal Public Safety Dispatch	incident report	Will County Sheriff Communications Center
Municipal Public Safety Dispatch	incident response coordination	Will County Sheriff Communications Center
Municipal Public Safety Dispatch	incident report	Wisconsin Municipal Public Safety
Municipal Public Safety Dispatch	incident response coordination	Wisconsin Municipal Public Safety
Municipal TMCs	incident information	Cook County Highway Department Maintenance Bureau
Municipal TMCs	maint and constr resource request	DuPage County Maintenance
Municipal TMCs	incident information	DuPage County Maintenance
Municipal TMCs	traffic information coordination	Illinois Gateway
Municipal TMCs	resource deployment status	Kane County 911 Center
Municipal TMCs	maint and constr resource request	Kane County Maintenance
Municipal TMCs	incident information	Kane County Maintenance
Municipal TMCs	incident information	Lake County Communications Center
Municipal TMCs	incident information	Lake County Highway Maintenance
Municipal TMCs	incident information	McHenry County Maintenance
Municipal TMCs	road network conditions	Municipal EMCs
Municipal TMCs	incident information	Municipal EMCs
Municipal TMCs	resource deployment status	Municipal EMCs
Municipal TMCs	road network conditions	Municipal Public Safety Dispatch
Municipal TMCs	incident information	Municipal Public Safety Dispatch
Municipal TMCs	resource deployment status	Municipal Public Safety Dispatch
Municipal TMCs	maint and constr resource request	Municipal/ Township Maintenance
Municipal TMCs	maint and constr resource request	Will County Maintenance
Municipal TMCs	incident information	Will County Maintenance
Municipal/ Township Maintenance	maint and constr resource coordination	City of Chicago Bureau of Street Operations Dispatch
Municipal/ Township Maintenance	maint and constr resource coordination	City of Chicago DSS BOE Signal Maintenance
Municipal/ Township Maintenance	incident information	DuPage Area TMC
Municipal/ Township Maintenance	maint and constr resource response	DuPage Area TMC
Municipal/ Township Maintenance	maint and constr resource coordination	DuPage County Maintenance
Municipal/ Township Maintenance	maint and constr resource response	DuPage County TMC
Municipal/ Township Maintenance	incident information	IDOT District 1 Bureau of Traffic Signal Unit
Municipal/ Township Maintenance	maint and constr resource response	IDOT District 1 Bureau of Traffic Signal Unit
Municipal/ Township Maintenance	incident information	IDOT District 1 ComCenter
Municipal/ Township Maintenance	maint and constr resource coordination	IDOT District 1 ComCenter
Municipal/ Township Maintenance	incident information	Illinois Gateway

Source	Flow Name	Destination
Municipal/ Township Maintenance	maint and constr resource coordination	Kane County Maintenance
Municipal/ Township Maintenance	incident information	Lake County Communications Center
Municipal/ Township Maintenance	maint and constr resource coordination	Lake County Highway Maintenance
Municipal/ Township Maintenance	maint and constr resource response	Municipal TMCs
Municipal/ Township Maintenance	maint and constr resource coordination	Will County Maintenance
Municipal/ Township Maintenance	incident information	Will County TMC
Municipal/ Township Maintenance	maint and constr resource response	Will County TMC
Other County 911 Centers	incident report	DuPage County EOC
Other County 911 Centers	incident response coordination	DuPage County EOC
Other County 911 Centers	incident report	Kane County 911 Center
Other County 911 Centers	incident response coordination	Kane County 911 Center
Other County 911 Centers	incident report	McHenry County Sheriff Dispatch
Other County 911 Centers	incident response coordination	McHenry County Sheriff Dispatch
Other County 911 Centers	incident report	Will County Sheriff Communications Center
Other County 911 Centers	incident response coordination	Will County Sheriff Communications Center
Other County EOCs	incident report	DuPage County EOC
Other County EOCs	incident response coordination	DuPage County EOC
Other County EOCs	incident response coordination	Kane County EOC
Other County EOCs	incident response coordination	McHenry County EOC
Other County EOCs	incident report	Will County EOC
Other County EOCs	incident response coordination	Will County EOC
Private ISPs - Travel Information Services	request for road network conditions	City of Chicago DOT TMC
Private ISPs - Travel Information Services	request for road network conditions	Gateway Central
Private ISPs - Travel Information Services	request for road network conditions	IDOT District 1 Traffic Systems Center (TSC)
Private Sector Maintenance Contractor	maint and constr resource coordination	City of Chicago DSS BOE Signal Maintenance
Private Sector Maintenance Contractor	maint and constr resource response	Cook County TMC
Private Sector Maintenance Contractor	maint and constr resource response	DuPage County TMC
Private Sector Maintenance Contractor	maint and constr resource response	IDOT District 1 Bureau of Traffic Signal Unit
Private Sector Maintenance Contractor	maint and constr resource coordination	IDOT District 1 ComCenter
Private Sector Maintenance Contractor	maint and constr resource coordination	IDOT District 1 Maintenance Management
Private Sector Maintenance Contractor	maint and constr resource response	Kane County TMC
Private Sector Maintenance Contractor	maint and constr resource coordination	Lake County Highway Maintenance
Private Sector Maintenance Contractor	maint and constr resource response	Lake County TMC
Private Sector Maintenance Contractor	maint and constr resource response	McHenry County TMC
Private Sector Maintenance Contractor	maint and constr resource coordination	Will County Maintenance
Private Sector Maintenance Contractor	maint and constr resource response	Will County TMC
Private Tow and Recovery Operations	incident response status	City of Chicago DSS Traffic Services Dispatch
Private Tow and Recovery Operations	incident report	Cook County Sheriff Communications Center
Private Tow and Recovery Operations	incident response coordination	Cook County Sheriff Communications Center
Rail Freight Operations	railroad advisories	IDOT District 1 Bureau of Traffic Signal Unit
Rail Freight Operations	railroad schedules	IDOT District 1 Bureau of Traffic Signal Unit

Source	Flow Name	Destination
Rail Freight Operations	railroad advisories	IDOT District 1 ComCenter
Rail Freight Operations	railroad schedules	IDOT District 1 ComCenter
Regional Event Facilities	event plans	City of Chicago DOT TMC
Regional Event Facilities	event plans	Cook County TMC
Regional Event Facilities	event plans	DuPage County TMC
Regional Event Facilities	event plans	IDOT District 1 ComCenter
Regional Event Facilities	event plans	Illinois Gateway
Regional Event Facilities	event plans	Illinois State Police Dispatch (Districts 2, 5 and Chicago)
Regional Event Facilities	event plans	Kane County TMC
Regional Event Facilities	event plans	Lake County TMC
Regional Event Facilities	event plans	McHenry County TMC
Regional Event Facilities	event plans	Will County TMC
Satellite TMC Midway Airport	incident information request	City of Chicago 911 Emergency Communications Center
Satellite TMC Midway Airport	incident information	Cook County Sheriff Communications Center
Satellite TMC Midway Airport	resource deployment status	Cook County Sheriff Communications Center
Satellite TMC Midway Airport	incident information	IDOT District 1 ComCenter
Satellite TMC Midway Airport	incident information request	IDOT District 1 ComCenter
Satellite TMC Midway Airport	traffic information coordination	IDOT District 1 Traffic Systems Center (TSC)
Satellite TMC Midway Airport	traffic information coordination	South Suburban Airport TMC
Satellite TMC OHare Airport	road network conditions	City of Chicago 911 Emergency Communications Center
Satellite TMC OHare Airport	incident information	City of Chicago 911 Emergency Communications Center
Satellite TMC OHare Airport	resource deployment status	City of Chicago 911 Emergency Communications Center
Satellite TMC OHare Airport	maint and constr resource request	Cook County Highway Department Maintenance Bureau
Satellite TMC OHare Airport	incident information	Cook County Highway Department Maintenance Bureau
Satellite TMC OHare Airport	incident information	Cook County Sheriff Communications Center
Satellite TMC OHare Airport	road network conditions	Cook County Sheriff Communications Center
Satellite TMC OHare Airport	traffic information coordination	DuPage Area TMC
South Suburban Airport TMC	traffic information coordination	IDOT District 1 Bureau of Traffic Signal Unit
South Suburban Airport TMC	traffic information coordination	Illinois Gateway
South Suburban Airport TMC	incident information	Municipal Public Safety Dispatch
South Suburban Airport TMC	traffic information coordination	Satellite TMC Midway Airport
South Suburban Airport TMC	incident information	Will County Sheriff Communications Center
South Suburban Airport TMC	resource deployment status	Will County Sheriff Communications Center
South Suburban Airport TMC	road network conditions	Will County Sheriff Communications Center
Utility Company Dispatch	maint and constr resource response	City of Chicago 911 Emergency Communications Center
Utility Company Dispatch	maint and constr resource response	DuPage County TMC
Utility Company Dispatch	maint and constr resource coordination	IDOT District 1 ComCenter
Will County EOC	incident report	DuPage County EOC
Will County EOC	incident response coordination	DuPage County EOC
Will County EOC	incident information	IDOT District 1 ComCenter
Will County EOC	incident information	Illinois Gateway

Source	Flow Name	Destination
Will County EOC	incident response status	Illinois Gateway
Will County EOC	resource request	Illinois Gateway
Will County EOC	incident report	Other County EOCs
Will County EOC	incident response coordination	Other County EOCs
Will County Maintenance	maint and constr resource coordination	Cook County Highway Department Maintenance Bureau
Will County Maintenance	maint and constr resource coordination	DuPage County Maintenance
Will County Maintenance	maint and constr resource coordination	IDOT District 1 Bureau of Traffic- Expressway Operations Unit
Will County Maintenance	maint and constr resource response	IDOT District 1 Bureau of Traffic Signal Unit
Will County Maintenance	incident information	IDOT District 1 Bureau of Traffic Signal Unit
Will County Maintenance	incident information	IDOT District 1 ComCenter
Will County Maintenance	maint and constr resource coordination	IDOT District 1 ComCenter
Will County Maintenance	maint and constr resource coordination	IDOT District 1 Maintenance Management
Will County Maintenance	incident information	Illinois Gateway
Will County Maintenance	maint and constr resource response	Illinois State Police Dispatch (Districts 2, 5 and Chicago)
Will County Maintenance	maint and constr resource response	Municipal TMCs
Will County Maintenance	incident information	Municipal TMCs
Will County Maintenance	maint and constr resource coordination	Municipal/ Township Maintenance
Will County Maintenance	maint and constr resource coordination	Private Sector Maintenance Contractor
Will County Maintenance	incident information	Will County Sheriff Communications Center
Will County Maintenance	maint and constr resource response	Will County TMC
Will County Maintenance	incident information	Will County TMC
Will County Sheriff Communications Center	incident report	Coast Guard Dispatch
Will County Sheriff Communications Center	incident response coordination	Coast Guard Dispatch
Will County Sheriff Communications Center	incident information	Cook County Highway Department Maintenance Bureau
Will County Sheriff Communications Center	incident report	Cook County Sheriff Communications Center
Will County Sheriff Communications Center	incident response coordination	Cook County Sheriff Communications Center
Will County Sheriff Communications Center	incident information	Cook County TMC
Will County Sheriff Communications Center	incident report	DuPage County EOC
Will County Sheriff Communications Center	incident response coordination	DuPage County EOC
Will County Sheriff Communications Center	incident report	DuPage County Sheriff Communications Center
Will County Sheriff Communications Center	incident response coordination	DuPage County Sheriff Communications Center
Will County Sheriff Communications Center	incident information	DuPage County TMC
Will County Sheriff Communications Center	incident response status	DuPage County TMC
Will County Sheriff Communications Center	incident information	IDOT District 1 Bureau of Traffic Signal Unit
Will County Sheriff Communications Center	incident information	IDOT District 1 ComCenter
Will County Sheriff Communications Center	resource request	IDOT District 1 ComCenter
Will County Sheriff Communications Center	incident information	IDOT District 1 Maintenance Management
Will County Sheriff Communications Center	incident response status	Illinois Gateway
Will County Sheriff Communications Center	resource request	Illinois Gateway
Will County Sheriff Communications Center	incident report	Illinois State Police Dispatch (Districts 2, 5 and Chicago)
Will County Sheriff Communications Center	incident response coordination	Illinois State Police Dispatch (Districts 2, 5 and Chicago)

Source	Flow Name	Destination
Will County Sheriff Communications Center	incident report	Illinois State Police District 15 Operations Desk
Will County Sheriff Communications Center	incident response coordination	Illinois State Police District 15 Operations Desk
Will County Sheriff Communications Center	incident report	Indiana County/ Municipal Public Safety Dispatch
Will County Sheriff Communications Center	incident response coordination	Indiana County/ Municipal Public Safety Dispatch
Will County Sheriff Communications Center	incident information	Indiana DOT Arterial TMC
Will County Sheriff Communications Center	incident report	Indiana State Police Dispatch
Will County Sheriff Communications Center	incident response coordination	Indiana State Police Dispatch
Will County Sheriff Communications Center	incident report	ISTHA Dispatch Center
Will County Sheriff Communications Center	incident response coordination	ISTHA Dispatch Center
Will County Sheriff Communications Center	incident report	Municipal Public Safety Dispatch
Will County Sheriff Communications Center	incident report	Other County 911 Centers
Will County Sheriff Communications Center	incident response coordination	Other County 911 Centers
Will County Sheriff Communications Center	incident information	South Suburban Airport TMC
Will County Sheriff Communications Center	incident response status	South Suburban Airport TMC
Will County Sheriff Communications Center	resource request	South Suburban Airport TMC
Will County TMC	maint and constr resource request	IDOT District 1 Bureau of Construction
Will County TMC	incident information	IDOT District 1 Bureau of Construction
Will County TMC	incident information	IDOT District 1 Bureau of Traffic- Expressway Operations Unit
Will County TMC	maint and constr resource request	IDOT District 1 Maintenance Management
Will County TMC	incident information	IDOT District 1 Maintenance Management
Will County TMC	incident information	Indiana County/ Municipal Public Safety Dispatch
Will County TMC	resource deployment status	Indiana County/ Municipal Public Safety Dispatch
Will County TMC	road network conditions	Indiana County/ Municipal Public Safety Dispatch
Will County TMC	maint and constr resource request	ISTHA Maintenance and Construction
Will County TMC	incident information	ISTHA Maintenance and Construction
Will County TMC	incident information	Municipal/ Township Maintenance
Will County TMC	maint and constr resource request	Municipal/ Township Maintenance
Will County TMC	maint and constr resource request	Private Sector Maintenance Contractor
Will County TMC	maint and constr resource request	Will County Maintenance
Will County TMC	incident information	Will County Maintenance
Wisconsin Gateway	request for road network conditions	Gateway Central
Wisconsin Gateway	road network conditions	Gateway Central
Wisconsin Municipal Public Safety	incident report	DuPage County EOC
Wisconsin Municipal Public Safety	incident response coordination	DuPage County EOC
Wisconsin Municipal Public Safety	incident report	Lake County Communications Center
Wisconsin Municipal Public Safety	incident response coordination	Lake County Communications Center
Wisconsin Municipal Public Safety	incident report	McHenry County EOC
Wisconsin Municipal Public Safety	incident response coordination	McHenry County EOC
Wisconsin Municipal Public Safety	incident report	McHenry County Sheriff Dispatch
Wisconsin Municipal Public Safety	incident response coordination	McHenry County Sheriff Dispatch
Wisconsin Municipal Public Safety	incident report	Municipal Public Safety Dispatch

ATMS08

Source	Flow Name	Destination
Wisconsin Municipal Public Safety	incident response coordination	Municipal Public Safety Dispatch
Wisconsin State Patrol District 2 Dispatch	incident report	Illinois State Police Dispatch (Districts 2, 5 and Chicago)
Wisconsin State Patrol District 2 Dispatch	incident response coordination	Illinois State Police Dispatch (Districts 2, 5 and Chicago)
Wisconsin State Patrol District 2 Dispatch	incident report	Illinois State Police District 15 Operations Desk
Wisconsin State Patrol District 2 Dispatch	incident response coordination	Illinois State Police District 15 Operations Desk
Wisconsin State Patrol District 2 Dispatch	incident report	ISTHA Dispatch Center
Wisconsin State Patrol District 2 Dispatch	incident response coordination	ISTHA Dispatch Center
Wisconsin State Patrol District 2 Dispatch	incident report	Lake County Communications Center
Wisconsin State Patrol District 2 Dispatch	incident response coordination	Lake County Communications Center
Wisconsin State Patrol District 2 Dispatch	incident information	Lake County TMC
Wisconsin State Patrol District 2 Dispatch	resource request	Lake County TMC
Wisconsin State Patrol District 2 Dispatch	incident report	McHenry County Sheriff Dispatch
Wisconsin State Patrol District 2 Dispatch	incident response coordination	McHenry County Sheriff Dispatch
WsDOT District 2 Traffic Operations Center	incident information	IDOT District 1 ComCenter
WsDOT District 2 Traffic Operations Center	road network conditions	IDOT District 1 ComCenter
WsDOT District 2 Traffic Operations Center	traffic information coordination	IDOT District 1 ComCenter
WsDOT District 2 Traffic Operations Center	traffic information coordination	IDOT District 1 Traffic Systems Center (TSC)
WsDOT District 2 Traffic Operations Center	road network conditions	ISTHA TMC (TIMS)
WsDOT District 2 Traffic Operations Center	traffic information coordination	ISTHA TMC (TIMS)
WsDOT District 2 Traffic Operations Center	traffic information coordination	Lake County TMC

Source	Flow Name	Destination
*999 Cellular Express Line	incident report	Illinois State Police Dispatch (Districts 2, 5 and Chicago)
*999 Cellular Express Line	incident response coordination	Illinois State Police Dispatch (Districts 2, 5 and Chicago)
Borman Traffic Management Center	resource deployment status	IDOT District 1 ComCenter
Borman Traffic Management Center	road network conditions	IDOT District 1 ComCenter
Borman Traffic Management Center	road network conditions	Illinois State Police District 15 Operations Desk
Chicago Transit Authority Control Center	transit emergency data	IDOT District 1 ComCenter
Chicago Transit Authority Paratransit Dispatch	transit emergency data	IDOT District 1 ComCenter
City of Chicago 311 Center	incident report	City of Chicago 911 Emergency Communications Center
City of Chicago 911 Emergency Communications Center	incident report	City of Chicago 311 Center
City of Chicago 911 Emergency Communications Center	incident report	City of Chicago Emergency Operations Center
City of Chicago 911 Emergency Communications Center	incident response coordination	City of Chicago Emergency Operations Center
City of Chicago 911 Emergency Communications Center	remote surveillance control	City of Chicago Skyway Operations
City of Chicago 911 Emergency Communications Center	resource request	City of Chicago Skyway Operations
City of Chicago 911 Emergency Communications Center	incident report	Coast Guard Dispatch
City of Chicago 911 Emergency Communications Center	incident response coordination	Coast Guard Dispatch
City of Chicago 911 Emergency Communications Center	incident response coordination	Cook County Sheriff Communications Center
City of Chicago 911 Emergency Communications Center	incident report	DuPage County EOC
City of Chicago 911 Emergency Communications Center	incident response coordination	DuPage County EOC
City of Chicago 911 Emergency Communications Center	remote surveillance control	IDOT District 1 ComCenter
City of Chicago 911 Emergency Communications Center	resource request	IDOT District 1 ComCenter
City of Chicago 911 Emergency Communications Center	remote surveillance control	IDOT District 1 Traffic Systems Center (TSC)
City of Chicago 911 Emergency Communications Center	resource request	IDOT District 1 Traffic Systems Center (TSC)
City of Chicago 911 Emergency Communications Center	incident report	IDOT Emergency Traffic Patrol (ETP)
City of Chicago 911 Emergency Communications Center	incident response coordination	IDOT Emergency Traffic Patrol (ETP)
City of Chicago 911 Emergency Communications Center	incident report	Illinois State Police District 15 Operations Desk
City of Chicago 911 Emergency Communications Center	incident response coordination	Illinois State Police District 15 Operations Desk
City of Chicago 911 Emergency Communications Center	transit emergency coordination	Independent School District Dispatch
City of Chicago 911 Emergency Communications Center	resource request	Indiana DOT Arterial TMC
City of Chicago 911 Emergency Communications Center	incident report	Indiana State Police Dispatch
City of Chicago 911 Emergency Communications Center	incident response coordination	Indiana State Police Dispatch
City of Chicago 911 Emergency Communications Center	resource request	Indiana Toll Road Operations Center
City of Chicago 911 Emergency Communications Center	incident information for media	Media
City of Chicago 911 Emergency Communications Center	remote surveillance control	Satellite TMC OHare Airport
City of Chicago 911 Emergency Communications Center	resource request	Satellite TMC OHare Airport
City of Chicago DOT TMC	resource deployment status	IDOT District 1 ComCenter
City of Chicago Emergency Operations Center	incident report	City of Chicago 911 Emergency Communications Center
City of Chicago Emergency Operations Center	incident response coordination	City of Chicago 911 Emergency Communications Center
City of Chicago Emergency Operations Center	incident report	Cook County EOC
City of Chicago Emergency Operations Center	incident response coordination	Cook County EOC



Source	Flow Name	Destination
City of Chicago Emergency Operations Center	incident report	DuPage County EOC
City of Chicago Emergency Operations Center	incident response coordination	DuPage County EOC
City of Chicago Emergency Operations Center	incident report	IDOT District 1 ComCenter
City of Chicago Emergency Operations Center	incident response coordination	IDOT District 1 ComCenter
City of Chicago Emergency Operations Center	incident report	Illinois State Operations Center
City of Chicago Emergency Operations Center	incident response coordination	Illinois State Operations Center
City of Chicago Emergency Operations Center	incident information for media	Media
City of Chicago Emergency Operations Center	incident report	Municipal EMCs
City of Chicago Emergency Operations Center	incident response coordination	Municipal EMCs
City of Chicago Skyway Operations	road network conditions	City of Chicago 911 Emergency Communications Center
City of Chicago Skyway Operations	resource deployment status	City of Chicago 911 Emergency Communications Center
City of Chicago Skyway Operations	resource deployment status	IDOT District 1 ComCenter
City of Chicago Skyway Operations	road network conditions	IDOT District 1 ComCenter
Coast Guard Dispatch	incident report	City of Chicago 911 Emergency Communications Center
Coast Guard Dispatch	incident response coordination	City of Chicago 911 Emergency Communications Center
Coast Guard Dispatch	incident report	Cook County Sheriff Communications Center
Coast Guard Dispatch	incident response coordination	Cook County Sheriff Communications Center
Coast Guard Dispatch	incident report	IDOT District 1 ComCenter
Coast Guard Dispatch	incident response coordination	IDOT District 1 ComCenter
Coast Guard Dispatch	incident report	Illinois State Police Dispatch (Districts 2, 5 and Chicago)
Coast Guard Dispatch	incident response coordination	Illinois State Police Dispatch (Districts 2, 5 and Chicago)
Coast Guard Dispatch	incident report	Lake County Communications Center
Coast Guard Dispatch	incident response coordination	Lake County Communications Center
Coast Guard Dispatch	incident report	Municipal Public Safety Dispatch
Coast Guard Dispatch	incident response coordination	Municipal Public Safety Dispatch
Coast Guard Dispatch	incident report	Will County Sheriff Communications Center
Coast Guard Dispatch	incident response coordination	Will County Sheriff Communications Center
Cook County EOC	incident report	City of Chicago Emergency Operations Center
Cook County EOC	incident response coordination	City of Chicago Emergency Operations Center
Cook County EOC	incident response coordination	Cook County Sheriff Communications Center
Cook County EOC	incident report	DuPage County EOC
Cook County EOC	incident response coordination	DuPage County EOC
Cook County EOC	incident report	IDOT District 1 ComCenter
Cook County EOC	incident response coordination	IDOT District 1 ComCenter
Cook County EOC	incident information for media	Media
Cook County Highway Department Construction Bureau	work zone information	Cook County Sheriff Communications Center
Cook County Highway Department Maintenance Bureau	work zone information	Cook County Sheriff Communications Center
Cook County Highway Department Maintenance Bureau	roadway maintenance status	Cook County Sheriff Communications Center
Cook County Highway Department Maintenance Bureau	work zone information	IDOT District 1 ComCenter

## EM1

Source	Flow Name	Destination
Cook County Highway Department Maintenance Bureau	roadway maintenance status	IDOT District 1 ComCenter
Cook County Sheriff Communications Center	incident response coordination	City of Chicago 911 Emergency Communications Center
Cook County Sheriff Communications Center	incident report	Coast Guard Dispatch
Cook County Sheriff Communications Center	incident response coordination	Coast Guard Dispatch
Cook County Sheriff Communications Center	incident report	Cook County EOC
Cook County Sheriff Communications Center	incident response coordination	Cook County EOC
Cook County Sheriff Communications Center	incident report	DuPage County EOC
Cook County Sheriff Communications Center	incident response coordination	DuPage County EOC
Cook County Sheriff Communications Center	incident report	DuPage County Sheriff Communications Center
Cook County Sheriff Communications Center	incident response coordination	DuPage County Sheriff Communications Center
Cook County Sheriff Communications Center	incident report	IDOT District 1 ComCenter
Cook County Sheriff Communications Center	incident response coordination	IDOT District 1 ComCenter
Cook County Sheriff Communications Center	resource request	IDOT District 1 ComCenter
Cook County Sheriff Communications Center	resource request	Illinois Gateway
Cook County Sheriff Communications Center	incident report	Illinois State Police Dispatch (Districts 2, 5 and Chicago)
Cook County Sheriff Communications Center	incident response coordination	Illinois State Police Dispatch (Districts 2, 5 and Chicago)
Cook County Sheriff Communications Center	transit emergency coordination	Independent School District Dispatch
Cook County Sheriff Communications Center	incident report	Kane County 911 Center
Cook County Sheriff Communications Center	incident response coordination	Kane County 911 Center
Cook County Sheriff Communications Center	incident report	Lake County Communications Center
Cook County Sheriff Communications Center	incident response coordination	Lake County Communications Center
Cook County Sheriff Communications Center	resource request	Lake County TMC
Cook County Sheriff Communications Center	incident information for media	Media
Cook County Sheriff Communications Center	incident report	Municipal Public Safety Dispatch
Cook County Sheriff Communications Center	incident response coordination	Municipal Public Safety Dispatch
Cook County Sheriff Communications Center	incident response coordination	Private Tow and Recovery Operations
Cook County Sheriff Communications Center	resource request	Satellite TMC Midway Airport
Cook County Sheriff Communications Center	incident report	Will County Sheriff Communications Center
Cook County Sheriff Communications Center	incident response coordination	Will County Sheriff Communications Center
DuPage Area TMC	resource deployment status	Municipal Public Safety Dispatch
DuPage Area TMC	road network conditions	Municipal Public Safety Dispatch
DuPage Centralized Paratransit Dispatch	transit emergency data	DuPage County EOC
DuPage Centralized Paratransit Dispatch	transit emergency data	IDOT District 1 ComCenter
DuPage Centralized Paratransit Dispatch	transit emergency data	Illinois State Police Dispatch (Districts 2, 5 and Chicago)
DuPage Centralized Paratransit Dispatch	transit emergency data	Illinois State Police District 15 Operations Desk
DuPage Centralized Paratransit Dispatch	transit emergency data	Will County Sheriff Communications Center
DuPage County EOC	incident report	City of Chicago 911 Emergency Communications Center
DuPage County EOC	incident response coordination	City of Chicago 911 Emergency Communications Center
DuPage County EOC	incident report	City of Chicago Emergency Operations Center

## EM1

Source	Flow Name	Destination
DuPage County EOC	incident response coordination	City of Chicago Emergency Operations Center
DuPage County EOC	incident report	Cook County EOC
DuPage County EOC	incident response coordination	Cook County EOC
DuPage County EOC	incident report	Cook County Sheriff Communications Center
DuPage County EOC	incident response coordination	Cook County Sheriff Communications Center
DuPage County EOC	transit emergency coordination	DuPage Centralized Paratransit Dispatch
DuPage County EOC	incident report	DuPage County Sheriff Communications Center
DuPage County EOC	incident response coordination	DuPage County Sheriff Communications Center
DuPage County EOC	resource request	DuPage County TMC
DuPage County EOC	resource request	Illinois Gateway
DuPage County EOC	incident report	Illinois State Operations Center
DuPage County EOC	incident response coordination	Illinois State Operations Center
DuPage County EOC	incident response coordination	Illinois State Police Dispatch (Districts 2, 5 and Chicago)
DuPage County EOC	incident report	Illinois State Police District 15 Operations Desk
DuPage County EOC	incident response coordination	Illinois State Police District 15 Operations Desk
DuPage County EOC	incident report	ISTHA Dispatch Center
DuPage County EOC	incident response coordination	ISTHA Dispatch Center
DuPage County EOC	incident report	Kane County 911 Center
DuPage County EOC	incident response coordination	Kane County 911 Center
DuPage County EOC	incident report	Kane County EOC
DuPage County EOC	incident response coordination	Kane County EOC
DuPage County EOC	incident report	Lake County Communications Center
DuPage County EOC	incident response coordination	Lake County Communications Center
DuPage County EOC	incident report	Lake County EOC
DuPage County EOC	incident response coordination	Lake County EOC
DuPage County EOC	incident report	McHenry County EOC
DuPage County EOC	incident response coordination	McHenry County EOC
DuPage County EOC	incident report	McHenry County Sheriff Dispatch
DuPage County EOC	incident response coordination	McHenry County Sheriff Dispatch
DuPage County EOC	incident information for media	Media
DuPage County EOC	transit emergency coordination	Metra Consolidated Control Facility
DuPage County EOC	incident report	Municipal EMCs
DuPage County EOC	incident response coordination	Municipal EMCs
DuPage County EOC	incident report	Municipal Public Safety Dispatch
DuPage County EOC	incident response coordination	Municipal Public Safety Dispatch
DuPage County EOC	incident report	Other County 911 Centers
DuPage County EOC	incident response coordination	Other County 911 Centers
DuPage County EOC	incident report	Other County EOCs
DuPage County EOC	incident response coordination	Other County EOCs

Source	Flow Name	Destination
DuPage County EOC	incident report	Will County EOC
DuPage County EOC	incident response coordination	Will County EOC
DuPage County EOC	incident report	Will County Sheriff Communications Center
DuPage County EOC	incident response coordination	Will County Sheriff Communications Center
DuPage County EOC	incident report	Wisconsin Municipal Public Safety
DuPage County EOC	incident response coordination	Wisconsin Municipal Public Safety
DuPage County Maintenance	work zone information	DuPage County Sheriff Communications Center
DuPage County Maintenance	roadway maintenance status	DuPage County Sheriff Communications Center
DuPage County Maintenance	work zone information	IDOT District 1 ComCenter
DuPage County Maintenance	work zone information	Illinois State Police Dispatch (Districts 2, 5 and Chicago)
DuPage County Maintenance	roadway maintenance status	Illinois State Police Dispatch (Districts 2, 5 and Chicago)
DuPage County Maintenance	work zone information	Municipal Public Safety Dispatch
DuPage County Maintenance	roadway maintenance status	Municipal Public Safety Dispatch
DuPage County Sheriff Communications Center	incident report	Cook County Sheriff Communications Center
DuPage County Sheriff Communications Center	incident response coordination	Cook County Sheriff Communications Center
DuPage County Sheriff Communications Center	incident report	DuPage County EOC
DuPage County Sheriff Communications Center	incident response coordination	DuPage County EOC
DuPage County Sheriff Communications Center	incident report	IDOT District 1 ComCenter
DuPage County Sheriff Communications Center	incident response coordination	IDOT District 1 ComCenter
DuPage County Sheriff Communications Center	resource request	IDOT District 1 ComCenter
DuPage County Sheriff Communications Center	resource request	Illinois Gateway
DuPage County Sheriff Communications Center	incident report	Illinois State Police Dispatch (Districts 2, 5 and Chicago)
DuPage County Sheriff Communications Center	incident response coordination	Illinois State Police Dispatch (Districts 2, 5 and Chicago)
DuPage County Sheriff Communications Center	transit emergency coordination	Independent School District Dispatch
DuPage County Sheriff Communications Center	incident report	Kane County 911 Center
DuPage County Sheriff Communications Center	incident response coordination	Kane County 911 Center
DuPage County Sheriff Communications Center	incident information for media	Media
DuPage County Sheriff Communications Center	incident report	Municipal Public Safety Dispatch
DuPage County Sheriff Communications Center	incident report	Will County Sheriff Communications Center
DuPage County Sheriff Communications Center	incident response coordination	Will County Sheriff Communications Center
DuPage County TMC	road network conditions	DuPage County EOC
DuPage County TMC	resource deployment status	DuPage County EOC
DuPage County TMC	road network conditions	DuPage County Sheriff Communications Center
DuPage County TMC	resource deployment status	IDOT District 1 ComCenter
DuPage County TMC	resource deployment status	Illinois State Police Dispatch (Districts 2, 5 and Chicago)
DuPage County TMC	road network conditions	Illinois State Police District 15 Operations Desk
DuPage County TMC	resource deployment status	Illinois State Police District 15 Operations Desk
DuPage County TMC	resource deployment status	Kane County 911 Center
DuPage County TMC	road network conditions	Kane County EOC

Source	Flow Name	Destination
DuPage County TMC	road network conditions	Municipal EMCs
DuPage County TMC	resource deployment status	Municipal Public Safety Dispatch
DuPage County TMC	road network conditions	Will County Sheriff Communications Center
Great Lakes Training Center	incident report	Lake County Communications Center
Great Lakes Training Center	incident response coordination	Lake County Communications Center
Great Lakes Training Center	incident report	Lake County EOC
Great Lakes Training Center	incident response coordination	Lake County EOC
Highway Emergency Lane Patrol Vehicles	incident command request	ISTHA Dispatch Center
Highway Emergency Lane Patrol Vehicles	incident status	ISTHA Dispatch Center
IDOT District 1 Bureau of Traffic- Expressway Operations	work zone information	Illinois State Police District 15 Operations Desk
IDOT District 1 Bureau of Traffic Signal Unit	road network conditions	Cook County Sheriff Communications Center
IDOT District 1 Bureau of Traffic Signal Unit	road network conditions	IDOT District 1 ComCenter
IDOT District 1 ComCenter	resource request	Borman Traffic Management Center
IDOT District 1 ComCenter	transit emergency coordination	Chicago Transit Authority Control Center
IDOT District 1 ComCenter	transit emergency coordination	Chicago Transit Authority Paratransit Dispatch
IDOT District 1 ComCenter	road network conditions	City of Chicago 911 Emergency Communications Center
IDOT District 1 ComCenter	resource deployment status	City of Chicago 911 Emergency Communications Center
IDOT District 1 ComCenter	resource request	City of Chicago DOT TMC
IDOT District 1 ComCenter	incident report	City of Chicago Emergency Operations Center
IDOT District 1 ComCenter	incident response coordination	City of Chicago Emergency Operations Center
IDOT District 1 ComCenter	resource request	City of Chicago Skyway Operations
IDOT District 1 ComCenter	incident report	Coast Guard Dispatch
IDOT District 1 ComCenter	incident response coordination	Coast Guard Dispatch
IDOT District 1 ComCenter	incident report	Cook County EOC
IDOT District 1 ComCenter	incident response coordination	Cook County EOC
IDOT District 1 ComCenter	incident report	Cook County Sheriff Communications Center
IDOT District 1 ComCenter	incident response coordination	Cook County Sheriff Communications Center
IDOT District 1 ComCenter	resource deployment status	Cook County Sheriff Communications Center
IDOT District 1 ComCenter	transit emergency coordination	DuPage Centralized Paratransit Dispatch
IDOT District 1 ComCenter	incident report	DuPage County Sheriff Communications Center
IDOT District 1 ComCenter	incident response coordination	DuPage County Sheriff Communications Center
IDOT District 1 ComCenter	resource deployment status	DuPage County Sheriff Communications Center
IDOT District 1 ComCenter	road network conditions	DuPage County Sheriff Communications Center
IDOT District 1 ComCenter	remote surveillance control	IDOT District 1 Bureau of Traffic Signal Unit
IDOT District 1 ComCenter	incident report	Illinois State Operations Center
IDOT District 1 ComCenter	incident response coordination	Illinois State Operations Center
IDOT District 1 ComCenter	transit emergency coordination	Independent School District Dispatch
IDOT District 1 ComCenter	incident report	Indiana County/ Municipal Public Safety Dispatch
IDOT District 1 ComCenter	incident response coordination	Indiana County/ Municipal Public Safety Dispatch

Source	Flow Name	Destination
IDOT District 1 ComCenter	incident report	Indiana State Police Dispatch
IDOT District 1 ComCenter	incident response coordination	Indiana State Police Dispatch
IDOT District 1 ComCenter	resource request	ISTHA TMC (TIMS)
IDOT District 1 ComCenter	incident report	Kane County 911 Center
IDOT District 1 ComCenter	incident response coordination	Kane County 911 Center
IDOT District 1 ComCenter	resource deployment status	Kane County 911 Center
IDOT District 1 ComCenter	incident report	Lake County Communications Center
IDOT District 1 ComCenter	incident response coordination	Lake County Communications Center
IDOT District 1 ComCenter	resource deployment status	Lake County Communications Center
IDOT District 1 ComCenter	incident report	Lake County EOC
IDOT District 1 ComCenter	incident response coordination	Lake County EOC
IDOT District 1 ComCenter	resource request	Lake County TMC
IDOT District 1 ComCenter	incident report	McHenry County Sheriff Dispatch
IDOT District 1 ComCenter	incident response coordination	McHenry County Sheriff Dispatch
IDOT District 1 ComCenter	resource deployment status	McHenry County Sheriff Dispatch
IDOT District 1 ComCenter	resource deployment status	Municipal Public Safety Dispatch
IDOT District 1 ComCenter	transit emergency coordination	Pace Paratransit Dispatch
IDOT District 1 ComCenter	resource deployment status	Will County Sheriff Communications Center
IDOT District 1 Maintenance Management	roadway maintenance status	IDOT District 1 ComCenter
IDOT District 1 Maintenance Management	work zone information	Illinois State Police Dispatch (Districts 2, 5 and Chicago)
IDOT District 1 Maintenance Management	roadway maintenance status	Illinois State Police Dispatch (Districts 2, 5 and Chicago)
IDOT District 1 Traffic Systems Center (TSC)	road network conditions	City of Chicago 911 Emergency Communications Center
IDOT District 1 Traffic Systems Center (TSC)	resource deployment status	City of Chicago 911 Emergency Communications Center
IDOT District 1 Traffic Systems Center (TSC)	road network conditions	ISTHA Dispatch Center
IDOT District 1 Traffic Systems Center (TSC)	resource deployment status	ISTHA Dispatch Center
IDOT Emergency Traffic Patrol (ETP)	incident report	City of Chicago 911 Emergency Communications Center
IDOT Emergency Traffic Patrol (ETP)	incident response coordination	City of Chicago 911 Emergency Communications Center
IDOT Emergency Traffic Patrol (ETP)	remote surveillance control	IDOT District 1 ComCenter
IDOT Emergency Traffic Patrol (ETP)	resource request	Illinois Gateway
IDOT Emergency Traffic Patrol Vehicles	incident command request	IDOT Emergency Traffic Patrol (ETP)
Illinois Gateway	resource deployment status	City of Chicago Emergency Operations Center
Illinois Gateway	resource deployment status	Cook County Sheriff Communications Center
Illinois Gateway	road network conditions	Cook County Sheriff Communications Center
Illinois Gateway	road network conditions	DuPage County EOC
Illinois Gateway	resource deployment status	DuPage County EOC
Illinois Gateway	resource deployment status	DuPage County Sheriff Communications Center
Illinois Gateway	resource deployment status	IDOT District 1 ComCenter
Illinois Gateway	road network conditions	IDOT Emergency Traffic Patrol (ETP)
Illinois Gateway	resource deployment status	IDOT Emergency Traffic Patrol (ETP)

Source	Flow Name	Destination
Illinois Gateway	resource deployment status	Illinois State Operations Center
Illinois Gateway	resource deployment status	ISTHA Dispatch Center
Illinois Gateway	resource deployment status	Kane County 911 Center
Illinois Gateway	resource deployment status	Kane County EOC
Illinois Gateway	resource deployment status	Lake County Communications Center
Illinois Gateway	road network conditions	McHenry County EOC
Illinois Gateway	resource deployment status	McHenry County Sheriff Dispatch
Illinois Gateway	road network conditions	Municipal EMCs
Illinois Gateway	resource deployment status	Municipal EMCs
Illinois Gateway	road network conditions	Municipal Public Safety Dispatch
Illinois Gateway	road network conditions	Will County EOC
Illinois Gateway	resource deployment status	Will County EOC
Illinois Gateway	road network conditions	Will County Sheriff Communications Center
Illinois Gateway	resource deployment status	Will County Sheriff Communications Center
Illinois State Operations Center	incident report	City of Chicago Emergency Operations Center
Illinois State Operations Center	incident response coordination	City of Chicago Emergency Operations Center
Illinois State Operations Center	incident report	DuPage County EOC
Illinois State Operations Center	incident response coordination	DuPage County EOC
Illinois State Operations Center	incident report	IDOT District 1 ComCenter
Illinois State Operations Center	incident response coordination	IDOT District 1 ComCenter
Illinois State Operations Center	resource request	IDOT District 1 ComCenter
Illinois State Operations Center	resource request	Illinois Gateway
Illinois State Operations Center	incident report	Illinois State Police Dispatch (Districts 2, 5 and Chicago)
Illinois State Operations Center	incident response coordination	Illinois State Police Dispatch (Districts 2, 5 and Chicago)
Illinois State Operations Center	incident report	Illinois State Police District 15 Operations Desk
Illinois State Operations Center	incident response coordination	Illinois State Police District 15 Operations Desk
Illinois State Operations Center	incident report	Kane County EOC
Illinois State Operations Center	incident response coordination	Kane County EOC
Illinois State Police Dispatch (Districts 2, 5 and Chicago)	incident report	*999 Cellular Express Line
Illinois State Police Dispatch (Districts 2, 5 and Chicago)	incident response coordination	*999 Cellular Express Line
Illinois State Police Dispatch (Districts 2, 5 and Chicago)	incident report	Coast Guard Dispatch
Illinois State Police Dispatch (Districts 2, 5 and Chicago)	incident response coordination	Coast Guard Dispatch
Illinois State Police Dispatch (Districts 2, 5 and Chicago)	incident report	Cook County Sheriff Communications Center
Illinois State Police Dispatch (Districts 2, 5 and Chicago)	incident response coordination	Cook County Sheriff Communications Center
Illinois State Police Dispatch (Districts 2, 5 and Chicago)	incident report	DuPage County Sheriff Communications Center
Illinois State Police Dispatch (Districts 2, 5 and Chicago)	incident response coordination	DuPage County Sheriff Communications Center
Illinois State Police Dispatch (Districts 2, 5 and Chicago)	remote surveillance control	IDOT District 1 ComCenter
Illinois State Police Dispatch (Districts 2, 5 and Chicago)	remote surveillance control	IDOT District 1 Traffic Systems Center (TSC)
Illinois State Police Dispatch (Districts 2, 5 and Chicago)	incident report	Illinois State Operations Center

Source	Flow Name	Destination
Illinois State Police Dispatch (Districts 2, 5 and Chicago)	incident response coordination	Illinois State Operations Center
Illinois State Police Dispatch (Districts 2, 5 and Chicago)	emergency dispatch requests	Illinois State Police Vehicles
Illinois State Police Dispatch (Districts 2, 5 and Chicago)	incident command information	Illinois State Police Vehicles
Illinois State Police Dispatch (Districts 2, 5 and Chicago)	transit emergency coordination	Independent School District Dispatch
Illinois State Police Dispatch (Districts 2, 5 and Chicago)	incident report	Indiana State Police Dispatch
Illinois State Police Dispatch (Districts 2, 5 and Chicago)	incident response coordination	Indiana State Police Dispatch
Illinois State Police Dispatch (Districts 2, 5 and Chicago)	incident report	Kane County 911 Center
Illinois State Police Dispatch (Districts 2, 5 and Chicago)	incident response coordination	Kane County 911 Center
Illinois State Police Dispatch (Districts 2, 5 and Chicago)	incident report	Lake County Communications Center
Illinois State Police Dispatch (Districts 2, 5 and Chicago)	incident response coordination	Lake County Communications Center
Illinois State Police Dispatch (Districts 2, 5 and Chicago)	resource request	Lake County TMC
Illinois State Police Dispatch (Districts 2, 5 and Chicago)	incident report	McHenry County Sheriff Dispatch
Illinois State Police Dispatch (Districts 2, 5 and Chicago)	incident response coordination	McHenry County Sheriff Dispatch
Illinois State Police Dispatch (Districts 2, 5 and Chicago)	incident information for media	Media
Illinois State Police Dispatch (Districts 2, 5 and Chicago)	incident report	Will County Sheriff Communications Center
Illinois State Police Dispatch (Districts 2, 5 and Chicago)	incident response coordination	Will County Sheriff Communications Center
Illinois State Police Dispatch (Districts 2, 5 and Chicago)	incident report	Wisconsin State Patrol District 2 Dispatch
Illinois State Police Dispatch (Districts 2, 5 and Chicago)	incident response coordination	Wisconsin State Patrol District 2 Dispatch
Illinois State Police District 15 Operations Desk	incident report	City of Chicago 911 Emergency Communications Center
Illinois State Police District 15 Operations Desk	incident response coordination	City of Chicago 911 Emergency Communications Center
Illinois State Police District 15 Operations Desk	incident report	DuPage County EOC
Illinois State Police District 15 Operations Desk	incident response coordination	DuPage County EOC
Illinois State Police District 15 Operations Desk	resource request	DuPage County TMC
Illinois State Police District 15 Operations Desk	resource request	IDOT District 1 ComCenter
Illinois State Police District 15 Operations Desk	incident report	Illinois State Operations Center
Illinois State Police District 15 Operations Desk	incident response coordination	Illinois State Operations Center
Illinois State Police District 15 Operations Desk	emergency dispatch requests	Illinois State Police Vehicles
Illinois State Police District 15 Operations Desk	incident command information	Illinois State Police Vehicles
Illinois State Police District 15 Operations Desk	incident report	Indiana State Police Dispatch
Illinois State Police District 15 Operations Desk	incident response coordination	Indiana State Police Dispatch
Illinois State Police District 15 Operations Desk	resource request	ISTHA TMC (TIMS)
Illinois State Police District 15 Operations Desk	incident report	Kane County 911 Center
Illinois State Police District 15 Operations Desk	incident response coordination	Kane County 911 Center
Illinois State Police District 15 Operations Desk	incident report	Lake County Communications Center
Illinois State Police District 15 Operations Desk	incident response coordination	Lake County Communications Center
Illinois State Police District 15 Operations Desk	resource request	Lake County TMC
Illinois State Police District 15 Operations Desk	incident information for media	Media
Illinois State Police District 15 Operations Desk	incident report	Will County Sheriff Communications Center
Illinois State Police District 15 Operations Desk	incident response coordination	Will County Sheriff Communications Center



Source	Flow Name	Destination
Illinois State Police District 15 Operations Desk	incident report	Wisconsin State Patrol District 2 Dispatch
Illinois State Police District 15 Operations Desk	incident response coordination	Wisconsin State Patrol District 2 Dispatch
Illinois State Police Vehicles	incident command request	Illinois State Police Dispatch (Districts 2, 5 and Chicago)
Illinois State Police Vehicles	incident status	Illinois State Police Dispatch (Districts 2, 5 and Chicago)
Illinois State Police Vehicles	incident command request	Illinois State Police District 15 Operations Desk
Illinois State Police Vehicles	incident status	Illinois State Police District 15 Operations Desk
Independent School District Dispatch	transit emergency data	City of Chicago 911 Emergency Communications Center
Independent School District Dispatch	transit emergency data	Cook County Sheriff Communications Center
Independent School District Dispatch	transit emergency data	DuPage County Sheriff Communications Center
Independent School District Dispatch	transit emergency data	IDOT District 1 ComCenter
Independent School District Dispatch	transit emergency data	Kane County 911 Center
Independent School District Dispatch	transit emergency data	Lake County Communications Center
Independent School District Dispatch	transit emergency data	McHenry County Sheriff Dispatch
Independent School District Dispatch	transit emergency data	Municipal Public Safety Dispatch
Independent School District Dispatch	transit emergency data	Will County Sheriff Communications Center
Indiana County/ Municipal Public Safety Dispatch	incident report	IDOT District 1 ComCenter
Indiana County/ Municipal Public Safety Dispatch	incident response coordination	IDOT District 1 ComCenter
Indiana County/ Municipal Public Safety Dispatch	incident report	Municipal Public Safety Dispatch
Indiana County/ Municipal Public Safety Dispatch	incident response coordination	Municipal Public Safety Dispatch
Indiana County/ Municipal Public Safety Dispatch	incident report	Will County Sheriff Communications Center
Indiana County/ Municipal Public Safety Dispatch	incident response coordination	Will County Sheriff Communications Center
Indiana County/ Municipal Public Safety Dispatch	resource request	Will County TMC
Indiana DOT Arterial TMC	resource deployment status	City of Chicago 911 Emergency Communications Center
Indiana State Police Dispatch	incident report	City of Chicago 911 Emergency Communications Center
Indiana State Police Dispatch	incident response coordination	City of Chicago 911 Emergency Communications Center
Indiana State Police Dispatch	incident report	IDOT District 1 ComCenter
Indiana State Police Dispatch	incident response coordination	IDOT District 1 ComCenter
Indiana State Police Dispatch	incident report	Illinois State Police Dispatch (Districts 2, 5 and Chicago)
Indiana State Police Dispatch	incident response coordination	Illinois State Police Dispatch (Districts 2, 5 and Chicago)
Indiana State Police Dispatch	incident report	Illinois State Police District 15 Operations Desk
Indiana State Police Dispatch	incident response coordination	Illinois State Police District 15 Operations Desk
Indiana State Police Dispatch	incident report	Will County Sheriff Communications Center
Indiana State Police Dispatch	incident response coordination	Will County Sheriff Communications Center
Indiana Toll Road Operations Center	resource deployment status	City of Chicago 911 Emergency Communications Center
Indiana Toll Road Operations Center	road network conditions	City of Chicago 911 Emergency Communications Center
ISTHA Dispatch Center	transit emergency coordination	Chicago Transit Authority Control Center
ISTHA Dispatch Center	incident report	DuPage County EOC
ISTHA Dispatch Center	incident response coordination	DuPage County EOC
ISTHA Dispatch Center	emergency dispatch requests	Highway Emergency Lane Patrol Vehicles

Source	Flow Name	Destination
ISTHA Dispatch Center	incident command information	Highway Emergency Lane Patrol Vehicles
ISTHA Dispatch Center	resource request	IDOT District 1 ComCenter
ISTHA Dispatch Center	remote surveillance control	IDOT District 1 Traffic Systems Center (TSC)
ISTHA Dispatch Center	resource request	IDOT District 1 Traffic Systems Center (TSC)
ISTHA Dispatch Center	resource request	Illinois Gateway
ISTHA Dispatch Center	remote surveillance control	ISTHA TMC (TIMS)
ISTHA Dispatch Center	resource request	ISTHA TMC (TIMS)
ISTHA Dispatch Center	incident report	Kenosha County Public Safety Dispatch
ISTHA Dispatch Center	incident response coordination	Kenosha County Public Safety Dispatch
ISTHA Dispatch Center	incident report	Lake County Communications Center
ISTHA Dispatch Center	incident response coordination	Lake County Communications Center
ISTHA Dispatch Center	incident report	Lake County EOC
ISTHA Dispatch Center	incident response coordination	Lake County EOC
ISTHA Dispatch Center	resource request	Lake County TMC
ISTHA Dispatch Center	incident information for media	Media
ISTHA Dispatch Center	incident report	Will County Sheriff Communications Center
ISTHA Dispatch Center	incident response coordination	Will County Sheriff Communications Center
ISTHA Dispatch Center	incident report	Wisconsin State Patrol District 2 Dispatch
ISTHA Dispatch Center	incident response coordination	Wisconsin State Patrol District 2 Dispatch
ISTHA Maintenance and Construction	work zone information	Illinois State Police District 15 Operations Desk
ISTHA Maintenance and Construction	roadway maintenance status	Illinois State Police District 15 Operations Desk
ISTHA Maintenance and Construction	roadway maintenance status	ISTHA Dispatch Center
ISTHA TMC (TIMS)	road network conditions	*999 Cellular Express Line
ISTHA TMC (TIMS)	resource deployment status	IDOT District 1 ComCenter
ISTHA TMC (TIMS)	road network conditions	Illinois State Police District 15 Operations Desk
ISTHA TMC (TIMS)	resource deployment status	Illinois State Police District 15 Operations Desk
ISTHA TMC (TIMS)	resource deployment status	ISTHA Dispatch Center
Kane County 911 Center	incident report	Cook County Sheriff Communications Center
Kane County 911 Center	incident response coordination	Cook County Sheriff Communications Center
Kane County 911 Center	incident report	DuPage County EOC
Kane County 911 Center	incident response coordination	DuPage County EOC
Kane County 911 Center	incident report	DuPage County Sheriff Communications Center
Kane County 911 Center	incident response coordination	DuPage County Sheriff Communications Center
Kane County 911 Center	resource request	DuPage County TMC
Kane County 911 Center	resource request	IDOT District 1 Bureau of Traffic Signal Unit
Kane County 911 Center	incident report	IDOT District 1 ComCenter
Kane County 911 Center	incident response coordination	IDOT District 1 ComCenter
Kane County 911 Center	resource request	IDOT District 1 ComCenter
Kane County 911 Center	resource request	Illinois Gateway

Source	Flow Name	Destination
Kane County 911 Center	incident report	Illinois State Police Dispatch (Districts 2, 5 and Chicago)
Kane County 911 Center	incident response coordination	Illinois State Police Dispatch (Districts 2, 5 and Chicago)
Kane County 911 Center	incident report	Illinois State Police District 15 Operations Desk
Kane County 911 Center	incident response coordination	Illinois State Police District 15 Operations Desk
Kane County 911 Center	transit emergency coordination	Independent School District Dispatch
Kane County 911 Center	incident report	Kane County EOC
Kane County 911 Center	incident response coordination	Kane County EOC
Kane County 911 Center	incident report	McHenry County Sheriff Dispatch
Kane County 911 Center	incident response coordination	McHenry County Sheriff Dispatch
Kane County 911 Center	incident information for media	Media
Kane County 911 Center	incident report	Municipal Public Safety Dispatch
Kane County 911 Center	incident response coordination	Municipal Public Safety Dispatch
Kane County 911 Center	incident report	Other County 911 Centers
Kane County 911 Center	incident response coordination	Other County 911 Centers
Kane County EOC	incident report	DuPage County EOC
Kane County EOC	incident response coordination	DuPage County EOC
Kane County EOC	resource request	Illinois Gateway
Kane County EOC	incident report	Illinois State Operations Center
Kane County EOC	incident response coordination	Illinois State Operations Center
Kane County EOC	incident report	Illinois State Police Dispatch (Districts 2, 5 and Chicago)
Kane County EOC	incident response coordination	Illinois State Police Dispatch (Districts 2, 5 and Chicago)
Kane County EOC	incident report	Kane County 911 Center
Kane County EOC	incident response coordination	Kane County 911 Center
Kane County EOC	incident report	McHenry County EOC
Kane County EOC	incident response coordination	McHenry County EOC
Kane County EOC	incident information for media	Media
Kane County EOC	incident report	Municipal EMCs
Kane County EOC	incident response coordination	Municipal EMCs
Kane County EOC	incident report	Municipal Public Safety Dispatch
Kane County EOC	incident response coordination	Municipal Public Safety Dispatch
Kane County EOC	incident report	Other County EOCs
Kane County EOC	incident response coordination	Other County EOCs
Kane County Maintenance	work zone information	IDOT District 1 ComCenter
Kane County Maintenance	work zone information	Illinois State Police Dispatch (Districts 2, 5 and Chicago)
Kane County Maintenance	roadway maintenance status	Illinois State Police Dispatch (Districts 2, 5 and Chicago)
Kane County Maintenance	work zone information	Kane County 911 Center
Kane County Maintenance	roadway maintenance status	Kane County 911 Center
Kane County Maintenance	work zone information	Kane County EOC
Kane County Maintenance	roadway maintenance status	Kane County EOC

Source	Flow Name	Destination
Kenosha County Public Safety Dispatch	incident report	ISTHA Dispatch Center
Kenosha County Public Safety Dispatch	incident response coordination	ISTHA Dispatch Center
Kenosha County Public Safety Dispatch	incident report	Lake County Communications Center
Kenosha County Public Safety Dispatch	incident response coordination	Lake County Communications Center
Kenosha County Public Safety Dispatch	incident report	Lake County EOC
Kenosha County Public Safety Dispatch	incident response coordination	Lake County EOC
Kenosha County Public Safety Dispatch	resource request	Lake County TMC
Kenosha County Public Safety Dispatch	incident report	McHenry County Sheriff Dispatch
Kenosha County Public Safety Dispatch	incident report	Municipal Public Safety Dispatch
Kenosha County Public Safety Dispatch	incident response coordination	Municipal Public Safety Dispatch
Lake County Communications Center	incident report	Coast Guard Dispatch
Lake County Communications Center	incident response coordination	Coast Guard Dispatch
Lake County Communications Center	incident report	Cook County Sheriff Communications Center
Lake County Communications Center	incident response coordination	Cook County Sheriff Communications Center
Lake County Communications Center	incident report	DuPage County EOC
Lake County Communications Center	incident response coordination	DuPage County EOC
Lake County Communications Center	incident report	Great Lakes Training Center
Lake County Communications Center	incident response coordination	Great Lakes Training Center
Lake County Communications Center	incident report	IDOT District 1 ComCenter
Lake County Communications Center	incident response coordination	IDOT District 1 ComCenter
Lake County Communications Center	resource request	IDOT District 1 ComCenter
Lake County Communications Center	resource request	Illinois Gateway
Lake County Communications Center	incident report	Illinois State Police Dispatch (Districts 2, 5 and Chicago)
Lake County Communications Center	incident response coordination	Illinois State Police Dispatch (Districts 2, 5 and Chicago)
Lake County Communications Center	incident report	Illinois State Police District 15 Operations Desk
Lake County Communications Center	incident response coordination	Illinois State Police District 15 Operations Desk
Lake County Communications Center	transit emergency coordination	Independent School District Dispatch
Lake County Communications Center	incident report	ISTHA Dispatch Center
Lake County Communications Center	incident response coordination	ISTHA Dispatch Center
Lake County Communications Center	incident report	Kenosha County Public Safety Dispatch
Lake County Communications Center	incident response coordination	Kenosha County Public Safety Dispatch
Lake County Communications Center	incident report	Lake County EOC
Lake County Communications Center	incident response coordination	Lake County EOC
Lake County Communications Center	incident report	McHenry County Sheriff Dispatch
Lake County Communications Center	incident response coordination	McHenry County Sheriff Dispatch
Lake County Communications Center	incident information for media	Media
Lake County Communications Center	incident report	Municipal Public Safety Dispatch
Lake County Communications Center	incident response coordination	Municipal Public Safety Dispatch
Lake County Communications Center	incident report	Wisconsin Municipal Public Safety

Source	Flow Name	Destination
Lake County Communications Center	incident response coordination	Wisconsin Municipal Public Safety
Lake County Communications Center	incident report	Wisconsin State Patrol District 2 Dispatch
Lake County Communications Center	incident response coordination	Wisconsin State Patrol District 2 Dispatch
Lake County EOC	incident report	DuPage County EOC
Lake County EOC	incident response coordination	DuPage County EOC
Lake County EOC	incident report	Great Lakes Training Center
Lake County EOC	incident response coordination	Great Lakes Training Center
Lake County EOC	incident report	IDOT District 1 ComCenter
Lake County EOC	incident response coordination	IDOT District 1 ComCenter
Lake County EOC	incident report	ISTHA Dispatch Center
Lake County EOC	incident response coordination	ISTHA Dispatch Center
Lake County EOC	incident report	Kenosha County Public Safety Dispatch
Lake County EOC	incident response coordination	Kenosha County Public Safety Dispatch
Lake County EOC	incident report	Lake County Communications Center
Lake County EOC	incident response coordination	Lake County Communications Center
Lake County EOC	incident report	McHenry County EOC
Lake County EOC	incident response coordination	McHenry County EOC
Lake County EOC	incident information for media	Media
Lake County Highway Construction	work zone information	IDOT District 1 ComCenter
Lake County Highway Construction	work zone information	Illinois State Police Dispatch (Districts 2, 5 and Chicago)
Lake County Highway Construction	roadway maintenance status	Illinois State Police Dispatch (Districts 2, 5 and Chicago)
Lake County Highway Construction	work zone information	Lake County Communications Center
Lake County Highway Construction	work zone information	Municipal Public Safety Dispatch
Lake County Highway Maintenance	work zone information	Lake County Communications Center
Lake County Highway Maintenance	roadway maintenance status	Lake County Communications Center
Lake County Highway Maintenance	work zone information	Municipal Public Safety Dispatch
Lake County TMC	resource deployment status	Cook County Sheriff Communications Center
Lake County TMC	resource deployment status	IDOT District 1 ComCenter
Lake County TMC	road network conditions	IDOT District 1 ComCenter
Lake County TMC	resource deployment status	Illinois State Police Dispatch (Districts 2, 5 and Chicago)
Lake County TMC	resource deployment status	Illinois State Police District 15 Operations Desk
Lake County TMC	resource deployment status	ISTHA Dispatch Center
Lake County TMC	resource deployment status	Kenosha County Public Safety Dispatch
Lake County TMC	road network conditions	Kenosha County Public Safety Dispatch
Lake County TMC	resource deployment status	Wisconsin State Patrol District 2 Dispatch
McHenry County EOC	incident report	DuPage County EOC
McHenry County EOC	incident response coordination	DuPage County EOC
McHenry County EOC	resource request	IDOT District 1 ComCenter
McHenry County EOC	incident report	Lake County EOC

Source	Flow Name	Destination
McHenry County EOC	incident response coordination	Lake County EOC
McHenry County EOC	incident report	McHenry County Sheriff Dispatch
McHenry County EOC	incident information for media	Media
McHenry County EOC	incident report	Other County EOCs
McHenry County EOC	incident response coordination	Other County EOCs
McHenry County EOC	incident report	Wisconsin Municipal Public Safety
McHenry County EOC	incident response coordination	Wisconsin Municipal Public Safety
McHenry County Maintenance	work zone information	Illinois State Police Dispatch (Districts 2, 5 and Chicago)
McHenry County Maintenance	roadway maintenance status	Illinois State Police Dispatch (Districts 2, 5 and Chicago)
McHenry County Maintenance	work zone information	McHenry County EOC
McHenry County Maintenance	work zone information	McHenry County Sheriff Dispatch
McHenry County Maintenance	roadway maintenance status	McHenry County Sheriff Dispatch
McHenry County Sheriff Dispatch	incident report	DuPage County EOC
McHenry County Sheriff Dispatch	incident response coordination	DuPage County EOC
McHenry County Sheriff Dispatch	incident report	IDOT District 1 ComCenter
McHenry County Sheriff Dispatch	incident response coordination	IDOT District 1 ComCenter
McHenry County Sheriff Dispatch	resource request	IDOT District 1 ComCenter
McHenry County Sheriff Dispatch	resource request	Illinois Gateway
McHenry County Sheriff Dispatch	incident report	Illinois State Police Dispatch (Districts 2, 5 and Chicago)
McHenry County Sheriff Dispatch	incident response coordination	Illinois State Police Dispatch (Districts 2, 5 and Chicago)
McHenry County Sheriff Dispatch	transit emergency coordination	Independent School District Dispatch
McHenry County Sheriff Dispatch	incident report	Kane County 911 Center
McHenry County Sheriff Dispatch	incident response coordination	Kane County 911 Center
McHenry County Sheriff Dispatch	incident report	Kenosha County Public Safety Dispatch
McHenry County Sheriff Dispatch	incident report	Lake County Communications Center
McHenry County Sheriff Dispatch	incident response coordination	Lake County Communications Center
McHenry County Sheriff Dispatch	resource request	Lake County TMC
McHenry County Sheriff Dispatch	incident report	McHenry County EOC
McHenry County Sheriff Dispatch	incident response coordination	McHenry County EOC
McHenry County Sheriff Dispatch	incident information for media	Media
McHenry County Sheriff Dispatch	incident report	Other County 911 Centers
McHenry County Sheriff Dispatch	incident response coordination	Other County 911 Centers
Media	media information request	City of Chicago 911 Emergency Communications Center
Media	media information request	City of Chicago Emergency Operations Center
Media	media information request	Cook County EOC
Media	media information request	Cook County Sheriff Communications Center
Media	media information request	DuPage County EOC
Media	media information request	DuPage County Sheriff Communications Center
Media	media information request	Illinois State Police Dispatch (Districts 2, 5 and Chicago)

Source	Flow Name	Destination
Media	media information request	Illinois State Police District 15 Operations Desk
Media	media information request	ISTHA Dispatch Center
Media	media information request	Kane County 911 Center
Media	media information request	Kane County EOC
Media	media information request	Lake County Communications Center
Media	media information request	Lake County EOC
Media	media information request	McHenry County EOC
Media	media information request	McHenry County Sheriff Dispatch
Media	media information request	Municipal EMCs
Media	media information request	Municipal Public Safety Dispatch
Media	media information request	Will County EOC
Media	media information request	Will County Sheriff Communications Center
Metra Consolidated Control Facility	transit emergency data	City of Chicago 911 Emergency Communications Center
Metra Consolidated Control Facility	transit emergency data	Illinois State Police Dispatch (Districts 2, 5 and Chicago)
Metra Consolidated Control Facility	transit emergency data	Municipal Public Safety Dispatch
Municipal EMCs	incident report	City of Chicago Emergency Operations Center
Municipal EMCs	incident response coordination	City of Chicago Emergency Operations Center
Municipal EMCs	incident report	DuPage County EOC
Municipal EMCs	incident response coordination	DuPage County EOC
Municipal EMCs	resource request	Illinois Gateway
Municipal EMCs	incident report	Illinois State Police Dispatch (Districts 2, 5 and Chicago)
Municipal EMCs	incident response coordination	Illinois State Police Dispatch (Districts 2, 5 and Chicago)
Municipal EMCs	incident report	Kane County EOC
Municipal EMCs	incident response coordination	Kane County EOC
Municipal EMCs	incident report	McHenry County EOC
Municipal EMCs	incident response coordination	McHenry County EOC
Municipal EMCs	incident information for media	Media
Municipal EMCs	resource request	Municipal TMCs
Municipal Public Safety Dispatch	incident report	City of Chicago 911 Emergency Communications Center
Municipal Public Safety Dispatch	incident response coordination	City of Chicago 911 Emergency Communications Center
Municipal Public Safety Dispatch	incident report	Coast Guard Dispatch
Municipal Public Safety Dispatch	incident response coordination	Coast Guard Dispatch
Municipal Public Safety Dispatch	incident report	Cook County Sheriff Communications Center
Municipal Public Safety Dispatch	incident response coordination	Cook County Sheriff Communications Center
Municipal Public Safety Dispatch	resource request	DuPage Area TMC
Municipal Public Safety Dispatch	incident report	DuPage County EOC
Municipal Public Safety Dispatch	incident response coordination	DuPage County EOC
Municipal Public Safety Dispatch	resource request	DuPage County TMC
Municipal Public Safety Dispatch	resource request	IDOT District 1 ComCenter

<b>Source</b>	<b>Flow Name</b>	<b>Destination</b>
Municipal Public Safety Dispatch	incident report	Illinois State Police Dispatch (Districts 2, 5 and Chicago)
Municipal Public Safety Dispatch	incident response coordination	Illinois State Police Dispatch (Districts 2, 5 and Chicago)
Municipal Public Safety Dispatch	transit emergency coordination	Independent School District Dispatch
Municipal Public Safety Dispatch	incident report	Indiana County/ Municipal Public Safety Dispatch
Municipal Public Safety Dispatch	incident response coordination	Indiana County/ Municipal Public Safety Dispatch
Municipal Public Safety Dispatch	incident report	Kane County 911 Center
Municipal Public Safety Dispatch	incident response coordination	Kane County 911 Center
Municipal Public Safety Dispatch	incident report	Kane County EOC
Municipal Public Safety Dispatch	incident response coordination	Kane County EOC
Municipal Public Safety Dispatch	incident report	Kenosha County Public Safety Dispatch
Municipal Public Safety Dispatch	incident response coordination	Kenosha County Public Safety Dispatch
Municipal Public Safety Dispatch	incident report	Lake County Communications Center
Municipal Public Safety Dispatch	incident response coordination	Lake County Communications Center
Municipal Public Safety Dispatch	incident report	McHenry County EOC
Municipal Public Safety Dispatch	incident response coordination	McHenry County EOC
Municipal Public Safety Dispatch	incident information for media	Media
Municipal Public Safety Dispatch	transit emergency coordination	Metra Consolidated Control Facility
Municipal Public Safety Dispatch	resource request	Municipal TMCs
Municipal Public Safety Dispatch	incident report	Will County EOC
Municipal Public Safety Dispatch	incident response coordination	Will County EOC
Municipal Public Safety Dispatch	incident report	Will County Sheriff Communications Center
Municipal Public Safety Dispatch	incident response coordination	Will County Sheriff Communications Center
Municipal Public Safety Dispatch	incident report	Wisconsin Municipal Public Safety
Municipal Public Safety Dispatch	incident response coordination	Wisconsin Municipal Public Safety
Municipal TMCs	resource deployment status	Kane County 911 Center
Municipal TMCs	road network conditions	Municipal EMCs
Municipal TMCs	resource deployment status	Municipal EMCs
Municipal TMCs	road network conditions	Municipal Public Safety Dispatch
Municipal TMCs	resource deployment status	Municipal Public Safety Dispatch
Other County 911 Centers	incident report	DuPage County EOC
Other County 911 Centers	incident response coordination	DuPage County EOC
Other County 911 Centers	incident report	Kane County 911 Center
Other County 911 Centers	incident response coordination	Kane County 911 Center
Other County 911 Centers	incident report	McHenry County Sheriff Dispatch
Other County 911 Centers	incident response coordination	McHenry County Sheriff Dispatch
Other County 911 Centers	incident report	Will County Sheriff Communications Center
Other County 911 Centers	incident response coordination	Will County Sheriff Communications Center
Other County EOCs	incident report	DuPage County EOC
Other County EOCs	incident response coordination	DuPage County EOC



## EM1

Source	Flow Name	Destination
Other County EOCs	incident response coordination	Kane County EOC
Other County EOCs	incident response coordination	McHenry County EOC
Other County EOCs	incident report	Will County EOC
Other County EOCs	incident response coordination	Will County EOC
Private Tow and Recovery Operations	incident report	Cook County Sheriff Communications Center
Private Tow and Recovery Operations	incident response coordination	Cook County Sheriff Communications Center
Satellite TMC Midway Airport	resource deployment status	Cook County Sheriff Communications Center
Satellite TMC OHare Airport	road network conditions	City of Chicago 911 Emergency Communications Center
Satellite TMC OHare Airport	resource deployment status	City of Chicago 911 Emergency Communications Center
Satellite TMC OHare Airport	road network conditions	Cook County Sheriff Communications Center
South Suburban Airport TMC	resource deployment status	Will County Sheriff Communications Center
South Suburban Airport TMC	road network conditions	Will County Sheriff Communications Center
Utility Company Dispatch	work zone information	City of Chicago 911 Emergency Communications Center
Will County EOC	incident report	DuPage County EOC
Will County EOC	incident response coordination	DuPage County EOC
Will County EOC	resource request	Illinois Gateway
Will County EOC	incident information for media	Media
Will County EOC	incident report	Other County EOCs
Will County EOC	incident response coordination	Other County EOCs
Will County Maintenance	work zone information	Illinois State Police Dispatch (Districts 2, 5 and Chicago)
Will County Maintenance	roadway maintenance status	Illinois State Police Dispatch (Districts 2, 5 and Chicago)
Will County Sheriff Communications Center	incident report	Coast Guard Dispatch
Will County Sheriff Communications Center	incident response coordination	Coast Guard Dispatch
Will County Sheriff Communications Center	incident report	Cook County Sheriff Communications Center
Will County Sheriff Communications Center	incident response coordination	Cook County Sheriff Communications Center
Will County Sheriff Communications Center	incident report	DuPage County EOC
Will County Sheriff Communications Center	incident response coordination	DuPage County EOC
Will County Sheriff Communications Center	incident report	DuPage County Sheriff Communications Center
Will County Sheriff Communications Center	incident response coordination	DuPage County Sheriff Communications Center
Will County Sheriff Communications Center	resource request	IDOT District 1 ComCenter
Will County Sheriff Communications Center	resource request	Illinois Gateway
Will County Sheriff Communications Center	incident report	Illinois State Police Dispatch (Districts 2, 5 and Chicago)
Will County Sheriff Communications Center	incident response coordination	Illinois State Police Dispatch (Districts 2, 5 and Chicago)
Will County Sheriff Communications Center	incident report	Illinois State Police District 15 Operations Desk
Will County Sheriff Communications Center	incident response coordination	Illinois State Police District 15 Operations Desk
Will County Sheriff Communications Center	transit emergency coordination	Independent School District Dispatch
Will County Sheriff Communications Center	incident report	Indiana County/ Municipal Public Safety Dispatch
Will County Sheriff Communications Center	incident response coordination	Indiana County/ Municipal Public Safety Dispatch
Will County Sheriff Communications Center	incident report	Indiana State Police Dispatch

Source	Flow Name	Destination
Will County Sheriff Communications Center	incident response coordination	Indiana State Police Dispatch
Will County Sheriff Communications Center	incident report	ISTHA Dispatch Center
Will County Sheriff Communications Center	incident response coordination	ISTHA Dispatch Center
Will County Sheriff Communications Center	incident information for media	Media
Will County Sheriff Communications Center	incident report	Municipal Public Safety Dispatch
Will County Sheriff Communications Center	incident report	Other County 911 Centers
Will County Sheriff Communications Center	incident response coordination	Other County 911 Centers
Will County Sheriff Communications Center	resource request	South Suburban Airport TMC
Will County TMC	resource deployment status	Indiana County/ Municipal Public Safety Dispatch
Will County TMC	road network conditions	Indiana County/ Municipal Public Safety Dispatch
Wisconsin Municipal Public Safety	incident report	DuPage County EOC
Wisconsin Municipal Public Safety	incident response coordination	DuPage County EOC
Wisconsin Municipal Public Safety	incident report	Lake County Communications Center
Wisconsin Municipal Public Safety	incident response coordination	Lake County Communications Center
Wisconsin Municipal Public Safety	incident report	McHenry County EOC
Wisconsin Municipal Public Safety	incident response coordination	McHenry County EOC
Wisconsin Municipal Public Safety	incident report	McHenry County Sheriff Dispatch
Wisconsin Municipal Public Safety	incident response coordination	McHenry County Sheriff Dispatch
Wisconsin Municipal Public Safety	incident report	Municipal Public Safety Dispatch
Wisconsin Municipal Public Safety	incident response coordination	Municipal Public Safety Dispatch
Wisconsin State Patrol District 2 Dispatch	incident report	Illinois State Police Dispatch (Districts 2, 5 and Chicago)
Wisconsin State Patrol District 2 Dispatch	incident response coordination	Illinois State Police Dispatch (Districts 2, 5 and Chicago)
Wisconsin State Patrol District 2 Dispatch	incident report	Illinois State Police District 15 Operations Desk
Wisconsin State Patrol District 2 Dispatch	incident response coordination	Illinois State Police District 15 Operations Desk
Wisconsin State Patrol District 2 Dispatch	incident report	ISTHA Dispatch Center
Wisconsin State Patrol District 2 Dispatch	incident response coordination	ISTHA Dispatch Center
Wisconsin State Patrol District 2 Dispatch	incident report	Lake County Communications Center
Wisconsin State Patrol District 2 Dispatch	incident response coordination	Lake County Communications Center
Wisconsin State Patrol District 2 Dispatch	resource request	Lake County TMC
Wisconsin State Patrol District 2 Dispatch	incident report	McHenry County Sheriff Dispatch
Wisconsin State Patrol District 2 Dispatch	incident response coordination	McHenry County Sheriff Dispatch
WSDOT District 2 Traffic Operations Center	road network conditions	IDOT District 1 ComCenter

Source	Flow Name	Destination
Borman Traffic Management Center	road network conditions	IDOT District 1 ComCenter
City of Chicago 911 Emergency Communications Center	maint and constr resource request	City of Chicago DSS BOE Signal Maintenance
City of Chicago 911 Emergency Communications Center	maint and constr resource request	Utility Company Dispatch
City of Chicago Bureau of Street Operations Dispatch	maint and constr resource response	City of Chicago 911 Emergency Communications Center
City of Chicago DOT BOS Roadway Maintenance	roadway maintenance status	City of Chicago DSS BOE Signal Maintenance
City of Chicago DOT BOS Roadway Maintenance	roadway maintenance status	Cook County Highway Department Construction Bureau
City of Chicago DOT BOS Roadway Maintenance	roadway maintenance status	Cook County Highway Department Maintenance Bureau
City of Chicago DOT BOS Roadway Maintenance	maint and constr resource response	IDOT District 1 Bureau of Traffic Signal Unit
City of Chicago DOT BOS Roadway Maintenance	roadway maintenance status	Independent School District Dispatch
City of Chicago DOT TMC	maint and constr resource request	City of Chicago DSS Traffic Services Dispatch
City of Chicago DOT TMC	maint and constr resource request	IDOT District 1 ComCenter
City of Chicago DOT TMC	maint and constr resource request	IDOT District 1 Maintenance Management
City of Chicago DSS BOE Signal Maintenance	maint and constr resource response	City of Chicago 911 Emergency Communications Center
City of Chicago DSS BOE Signal Maintenance	maint and constr resource response	City of Chicago DOT TMC
City of Chicago DSS BOE Signal Maintenance	maint and constr resource response	IDOT District 1 Bureau of Traffic Signal Unit
City of Chicago DSS Traffic Services Dispatch	maint and constr resource response	City of Chicago DOT TMC
City of Chicago DSS Traffic Services Dispatch	maint and constr resource response	City of Chicago Skyway Operations
City of Chicago DSS Traffic Services Dispatch	maint and constr resource response	Private Tow and Recovery Operations
City of Chicago Skyway Operations	maint and constr resource request	City of Chicago DSS Traffic Services Dispatch
City of Chicago Skyway Operations	maint and constr resource request	IDOT District 1 ComCenter
City of Chicago Skyway Operations	road network conditions	IDOT District 1 ComCenter
Cook County Highway Department Construction Bureau	maint and constr resource response	City of Chicago DOT TMC
Cook County Highway Department Construction Bureau	maint and constr resource response	IDOT District 1 Bureau of Traffic Signal Unit
Cook County Highway Department Maintenance Bureau	roadway maintenance status	City of Chicago DOT BOS Roadway Maintenance
Cook County Highway Department Maintenance Bureau	maint and constr resource response	City of Chicago DOT TMC
Cook County Highway Department Maintenance Bureau	roadway maintenance status	Cook County Sheriff Communications Center
Cook County Highway Department Maintenance Bureau	maint and constr resource response	Cook County TMC
Cook County Highway Department Maintenance Bureau	roadway maintenance status	DuPage County Maintenance
Cook County Highway Department Maintenance Bureau	roadway maintenance status	IDOT District 1 ComCenter
Cook County Highway Department Maintenance Bureau	roadway maintenance status	IDOT District 1 Maintenance Management
Cook County Highway Department Maintenance Bureau	maint and constr resource response	IDOT District 1 Traffic Systems Center (TSC)
Cook County Highway Department Maintenance Bureau	maint and constr resource response	Illinois State Police Dispatch (Districts 2, 5 and Chicago)
Cook County Highway Department Maintenance Bureau	roadway maintenance status	Independent School District Dispatch
Cook County Highway Department Maintenance Bureau	roadway maintenance status	Kane County Maintenance
Cook County Highway Department Maintenance Bureau	maint and constr resource response	Kane County TMC
Cook County Highway Department Maintenance Bureau	roadway maintenance status	Kane County TMC
Cook County Highway Department Maintenance Bureau	maint and constr resource response	Lake County TMC
Cook County Highway Department Maintenance Bureau	maint and constr resource response	Satellite TMC OHare Airport
Cook County Sheriff Communications Center	maint and constr resource request	IDOT District 1 Maintenance Management
Cook County TMC	maint and constr resource request	Cook County Highway Department Maintenance Bureau

Source	Flow Name	Destination
Cook County TMC	maint and constr resource request	IDOT District 1 Maintenance Management
Cook County TMC	maint and constr resource request	Kane County Maintenance
Cook County TMC	maint and constr resource request	Lake County Highway Maintenance
Cook County TMC	maint and constr resource request	Private Sector Maintenance Contractor
DuPage Area TMC	maint and constr resource request	Municipal/ Township Maintenance
DuPage Area TMC	road network conditions	Municipal/ Township Maintenance
DuPage County EOC	maint and constr resource request	DuPage County Maintenance
DuPage County Maintenance	roadway maintenance status	Cook County Highway Department Maintenance Bureau
DuPage County Maintenance	maint and constr resource response	DuPage County EOC
DuPage County Maintenance	roadway maintenance status	DuPage County Sheriff Communications Center
DuPage County Maintenance	maint and constr resource response	DuPage County TMC
DuPage County Maintenance	roadway maintenance status	DuPage County TMC
DuPage County Maintenance	roadway maintenance status	IDOT District 1 Maintenance Management
DuPage County Maintenance	maint and constr resource response	IDOT District 1 Traffic Systems Center (TSC)
DuPage County Maintenance	maint and constr resource response	Illinois State Police Dispatch (Districts 2, 5 and Chicago)
DuPage County Maintenance	roadway maintenance status	Illinois State Police Dispatch (Districts 2, 5 and Chicago)
DuPage County Maintenance	roadway maintenance status	Independent School District Dispatch
DuPage County Maintenance	roadway maintenance status	ISTHA Maintenance and Construction
DuPage County Maintenance	maint and constr resource response	Kane County EOC
DuPage County Maintenance	roadway maintenance status	Kane County Maintenance
DuPage County Maintenance	maint and constr resource response	Kane County TMC
DuPage County Maintenance	roadway maintenance status	Kane County TMC
DuPage County Maintenance	roadway maintenance status	Municipal Public Safety Dispatch
DuPage County Maintenance	maint and constr resource response	Municipal TMCs
DuPage County Maintenance	roadway maintenance status	Will County Maintenance
DuPage County Sheriff Communications Center	maint and constr resource request	IDOT District 1 Maintenance Management
DuPage County TMC	maint and constr resource request	DuPage County Maintenance
DuPage County TMC	maint and constr resource request	IDOT District 1 ComCenter
DuPage County TMC	maint and constr resource request	IDOT District 1 Maintenance Management
DuPage County TMC	maint and constr resource request	Municipal/ Township Maintenance
DuPage County TMC	maint and constr resource request	Private Sector Maintenance Contractor
DuPage County TMC	maint and constr resource request	Utility Company Dispatch
DuPage County TMC	road network conditions	Will County Maintenance
IDOT District 1 Bureau of Construction	roadway maintenance status	City of Chicago DOT BOS Roadway Maintenance
IDOT District 1 Bureau of Construction	storage facility request	IDOT District 1 Maintenance Yards
IDOT District 1 Bureau of Construction	maint and constr resource response	ISTHA TMC (TIMS)
IDOT District 1 Bureau of Construction	maint and constr resource response	Will County TMC
IDOT District 1 Bureau of Traffic Signal Unit	maint and constr resource request	City of Chicago DOT BOS Roadway Maintenance
IDOT District 1 Bureau of Traffic Signal Unit	maint and constr resource request	City of Chicago DSS BOE Signal Maintenance
IDOT District 1 Bureau of Traffic Signal Unit	maint and constr resource request	Cook County Highway Department Construction Bureau

Source	Flow Name	Destination
IDOT District 1 Bureau of Traffic Signal Unit	maint and constr resource request	Cook County Highway Department Maintenance Bureau
IDOT District 1 Bureau of Traffic Signal Unit	road network conditions	IDOT District 1 ComCenter
IDOT District 1 Bureau of Traffic Signal Unit	maint and constr resource request	ISTHA Maintenance and Construction
IDOT District 1 Bureau of Traffic Signal Unit	maint and constr resource request	Kane County Maintenance
IDOT District 1 Bureau of Traffic Signal Unit	maint and constr resource request	Lake County Highway Maintenance
IDOT District 1 Bureau of Traffic Signal Unit	maint and constr resource request	McHenry County Maintenance
IDOT District 1 Bureau of Traffic Signal Unit	maint and constr resource request	Municipal/ Township Maintenance
IDOT District 1 Bureau of Traffic Signal Unit	maint and constr resource request	Private Sector Maintenance Contractor
IDOT District 1 Bureau of Traffic Signal Unit	maint and constr resource request	Will County Maintenance
IDOT District 1 ComCenter	roadway maintenance status	Chicago Transit Authority Control Center
IDOT District 1 ComCenter	maint and constr resource response	City of Chicago DOT TMC
IDOT District 1 ComCenter	maint and constr resource response	City of Chicago Skyway Operations
IDOT District 1 ComCenter	maint and constr resource response	DuPage County TMC
IDOT District 1 ComCenter	storage facility request	IDOT District 1 Maintenance Yards
IDOT District 1 ComCenter	maint and constr dispatch information	IDOT Maintenance Vehicles
IDOT District 1 ComCenter	maint and constr vehicle system	IDOT Maintenance Vehicles
IDOT District 1 ComCenter	maint and constr resource response	Illinois State Police District 15 Operations Desk
IDOT District 1 ComCenter	roadway maintenance status	Independent School District Dispatch
IDOT District 1 ComCenter	maint and constr resource response	ISTHA TMC (TIMS)
IDOT District 1 Maintenance Management	roadway maintenance status	City of Chicago DOT BOS Roadway Maintenance
IDOT District 1 Maintenance Management	maint and constr resource response	City of Chicago DOT TMC
IDOT District 1 Maintenance Management	maint and constr resource response	Cook County Sheriff Communications Center
IDOT District 1 Maintenance Management	maint and constr resource response	Cook County TMC
IDOT District 1 Maintenance Management	roadway maintenance status	Cook County TMC
IDOT District 1 Maintenance Management	roadway maintenance status	DuPage County Maintenance
IDOT District 1 Maintenance Management	maint and constr resource response	DuPage County Sheriff Communications Center
IDOT District 1 Maintenance Management	maint and constr resource response	DuPage County TMC
IDOT District 1 Maintenance Management	roadway maintenance status	DuPage County TMC
IDOT District 1 Maintenance Management	roadway maintenance status	IDOT District 1 Bureau of Construction
IDOT District 1 Maintenance Management	roadway maintenance status	IDOT District 1 Bureau of Traffic Signal Unit
IDOT District 1 Maintenance Management	roadway maintenance status	IDOT District 1 ComCenter
IDOT District 1 Maintenance Management	storage facility request	IDOT District 1 Maintenance Yards
IDOT District 1 Maintenance Management	roadway maintenance status	IDOT District 1 Traffic Systems Center (TSC)
IDOT District 1 Maintenance Management	maint and constr dispatch information	IDOT Maintenance Vehicles
IDOT District 1 Maintenance Management	roadway maintenance status	Illinois Gateway
IDOT District 1 Maintenance Management	maint and constr resource response	Illinois State Police Dispatch (Districts 2, 5 and Chicago)
IDOT District 1 Maintenance Management	roadway maintenance status	Illinois State Police Dispatch (Districts 2, 5 and Chicago)
IDOT District 1 Maintenance Management	maint and constr resource response	Illinois State Police District 15 Operations Desk
IDOT District 1 Maintenance Management	maint and constr resource response	ISTHA TMC (TIMS)
IDOT District 1 Maintenance Management	roadway maintenance status	Kane County Maintenance

Source	Flow Name	Destination
IDOT District 1 Maintenance Management	roadway maintenance status	Lake County Highway Maintenance
IDOT District 1 Maintenance Management	maint and constr resource response	Lake County TMC
IDOT District 1 Maintenance Management	roadway maintenance status	McHenry County Maintenance
IDOT District 1 Maintenance Management	maint and constr resource response	Municipal Public Safety Dispatch
IDOT District 1 Maintenance Management	roadway maintenance status	Will County Maintenance
IDOT District 1 Maintenance Management	maint and constr resource response	Will County TMC
IDOT District 1 Maintenance Yards	equipment availability	IDOT District 1 Bureau of Construction
IDOT District 1 Maintenance Yards	equipment availability	IDOT District 1 ComCenter
IDOT District 1 Maintenance Yards	maintenance materials storage status	IDOT District 1 ComCenter
IDOT District 1 Maintenance Yards	equipment availability	IDOT District 1 Maintenance Management
IDOT District 1 Maintenance Yards	maintenance materials storage status	IDOT District 1 Maintenance Management
IDOT District 1 Maintenance Yards	equipment availability	Lake County Highway Maintenance
IDOT District 1 Maintenance Yards	maintenance materials storage status	Lake County Highway Maintenance
IDOT District 1 Traffic Systems Center (TSC)	maint and constr resource request	Cook County Highway Department Maintenance Bureau
IDOT District 1 Traffic Systems Center (TSC)	maint and constr resource request	DuPage County Maintenance
IDOT District 1 Traffic Systems Center (TSC)	maint and constr resource request	ISTHA Maintenance and Construction
IDOT Maintenance Vehicles	maint and constr dispatch status	IDOT District 1 ComCenter
IDOT Maintenance Vehicles	maint and constr vehicle operational	IDOT District 1 ComCenter
IDOT Maintenance Vehicles	maint and constr dispatch status	IDOT District 1 Maintenance Management
IDOT Maintenance Vehicles	maint and constr vehicle operational	IDOT District 1 Maintenance Management
Illinois State Police Dispatch (Districts 2, 5 and Chicago)	maint and constr resource request	Cook County Highway Department Maintenance Bureau
Illinois State Police Dispatch (Districts 2, 5 and Chicago)	maint and constr resource request	DuPage County Maintenance
Illinois State Police Dispatch (Districts 2, 5 and Chicago)	maint and constr resource request	IDOT District 1 Maintenance Management
Illinois State Police Dispatch (Districts 2, 5 and Chicago)	maint and constr resource request	Kane County Maintenance
Illinois State Police Dispatch (Districts 2, 5 and Chicago)	maint and constr resource request	Lake County Highway Maintenance
Illinois State Police Dispatch (Districts 2, 5 and Chicago)	maint and constr resource request	McHenry County Maintenance
Illinois State Police Dispatch (Districts 2, 5 and Chicago)	maint and constr resource request	Will County Maintenance
Illinois State Police District 15 Operations Desk	maint and constr resource request	IDOT District 1 ComCenter
Illinois State Police District 15 Operations Desk	maint and constr resource request	IDOT District 1 Maintenance Management
Illinois State Police District 15 Operations Desk	maint and constr resource request	ISTHA Maintenance and Construction
ISTHA Dispatch Center	maint and constr resource request	ISTHA Maintenance and Construction
ISTHA Maintenance and Construction	roadway maintenance status	DuPage County Maintenance
ISTHA Maintenance and Construction	maint and constr resource response	IDOT District 1 Bureau of Traffic Signal Unit
ISTHA Maintenance and Construction	maint and constr resource response	IDOT District 1 Traffic Systems Center (TSC)
ISTHA Maintenance and Construction	maint and constr resource response	Illinois State Police District 15 Operations Desk
ISTHA Maintenance and Construction	roadway maintenance status	Illinois State Police District 15 Operations Desk
ISTHA Maintenance and Construction	maint and constr resource response	ISTHA Dispatch Center
ISTHA Maintenance and Construction	roadway maintenance status	ISTHA Dispatch Center
ISTHA Maintenance and Construction	roadway maintenance status	Kenosha County Highway Maintenance
ISTHA Maintenance and Construction	roadway maintenance status	Lake County Highway Maintenance

Source	Flow Name	Destination
ISTHA Maintenance and Construction	maint and constr resource response	Lake County TMC
ISTHA Maintenance and Construction	maint and constr resource response	Will County TMC
ISTHA TMC (TIMS)	maint and constr resource request	IDOT District 1 Bureau of Construction
ISTHA TMC (TIMS)	maint and constr resource request	IDOT District 1 ComCenter
ISTHA TMC (TIMS)	maint and constr resource request	IDOT District 1 Maintenance Management
Kane County EOC	maint and constr resource request	DuPage County Maintenance
Kane County EOC	maint and constr resource request	Kane County Maintenance
Kane County Maintenance	roadway maintenance status	Cook County Highway Department Maintenance Bureau
Kane County Maintenance	roadway maintenance status	DuPage County Maintenance
Kane County Maintenance	maint and constr resource response	IDOT District 1 Bureau of Traffic Signal Unit
Kane County Maintenance	roadway maintenance status	IDOT District 1 Maintenance Management
Kane County Maintenance	maint and constr resource response	Illinois State Police Dispatch (Districts 2, 5 and Chicago)
Kane County Maintenance	roadway maintenance status	Illinois State Police Dispatch (Districts 2, 5 and Chicago)
Kane County Maintenance	roadway maintenance status	Kane County 911 Center
Kane County Maintenance	maint and constr resource response	Kane County EOC
Kane County Maintenance	roadway maintenance status	Kane County EOC
Kane County Maintenance	maint and constr resource response	Kane County TMC
Kane County Maintenance	roadway maintenance status	Kane County TMC
Kane County Maintenance	roadway maintenance status	McHenry County Maintenance
Kane County Maintenance	maint and constr resource response	Municipal TMCs
Kane County Maintenance	roadway maintenance status	Municipal/ Township Maintenance
Kane County TMC	maint and constr resource request	Cook County Highway Department Maintenance Bureau
Kane County TMC	road network conditions	Cook County Highway Department Maintenance Bureau
Kane County TMC	maint and constr resource request	DuPage County Maintenance
Kane County TMC	road network conditions	DuPage County Maintenance
Kane County TMC	maint and constr resource request	Kane County Maintenance
Kane County TMC	road network conditions	Kane County Maintenance
Kane County TMC	maint and constr resource request	McHenry County Maintenance
Kane County TMC	maint and constr resource request	Private Sector Maintenance Contractor
Kenosha County Highway Maintenance	roadway maintenance status	ISTHA Maintenance and Construction
Kenosha County Highway Maintenance	roadway maintenance status	Lake County Highway Maintenance
Lake County Communications Center	maint and constr resource request	Lake County Highway Construction
Lake County Communications Center	maint and constr resource request	Lake County Highway Maintenance
Lake County Highway Construction	roadway maintenance status	Illinois State Police Dispatch (Districts 2, 5 and Chicago)
Lake County Highway Construction	maint and constr resource response	Lake County Communications Center
Lake County Highway Construction	maint and constr resource response	Lake County TMC
Lake County Highway Construction	maint and constr resource response	Municipal Public Safety Dispatch
Lake County Highway Maintenance	maint and constr resource response	IDOT District 1 Bureau of Traffic Signal Unit
Lake County Highway Maintenance	roadway maintenance status	IDOT District 1 Maintenance Management
Lake County Highway Maintenance	storage facility request	IDOT District 1 Maintenance Yards

Source	Flow Name	Destination
Lake County Highway Maintenance	maint and constr resource response	Illinois State Police Dispatch (Districts 2, 5 and Chicago)
Lake County Highway Maintenance	roadway maintenance status	ISTHA Maintenance and Construction
Lake County Highway Maintenance	roadway maintenance status	Kenosha County Highway Maintenance
Lake County Highway Maintenance	maint and constr resource response	Lake County Communications Center
Lake County Highway Maintenance	roadway maintenance status	Lake County Communications Center
Lake County Highway Maintenance	roadway maintenance status	Lake County Highway Construction
Lake County Highway Maintenance	maint and constr resource response	Lake County TMC
Lake County Highway Maintenance	roadway maintenance status	Lake County TMC
Lake County Highway Maintenance	maint and constr resource response	McHenry County TMC
Lake County Highway Maintenance	roadway maintenance status	McHenry County TMC
Lake County Highway Maintenance	maint and constr resource response	Municipal Public Safety Dispatch
Lake County Highway Maintenance	roadway maintenance status	Municipal/ Township Maintenance
Lake County Highway Maintenance	roadway maintenance status	Private Sector Maintenance Contractor
Lake County TMC	maint and constr resource request	Cook County Highway Department Maintenance Bureau
Lake County TMC	road network conditions	Cook County Highway Department Maintenance Bureau
Lake County TMC	maint and constr resource request	IDOT District 1 ComCenter
Lake County TMC	road network conditions	IDOT District 1 ComCenter
Lake County TMC	maint and constr resource request	IDOT District 1 Maintenance Management
Lake County TMC	maint and constr resource request	ISTHA Maintenance and Construction
Lake County TMC	maint and constr resource request	Lake County Highway Construction
Lake County TMC	maint and constr resource request	Lake County Highway Maintenance
Lake County TMC	road network conditions	Lake County Highway Maintenance
Lake County TMC	maint and constr resource request	McHenry County Maintenance
Lake County TMC	maint and constr resource request	Private Sector Maintenance Contractor
McHenry County EOC	maint and constr resource request	McHenry County Maintenance
McHenry County Maintenance	maint and constr resource response	IDOT District 1 Bureau of Traffic Signal Unit
McHenry County Maintenance	maint and constr resource response	Illinois State Police Dispatch (Districts 2, 5 and Chicago)
McHenry County Maintenance	roadway maintenance status	Illinois State Police Dispatch (Districts 2, 5 and Chicago)
McHenry County Maintenance	maint and constr resource response	Lake County TMC
McHenry County Maintenance	maint and constr resource response	McHenry County EOC
McHenry County Maintenance	roadway maintenance status	McHenry County Sheriff Dispatch
McHenry County Maintenance	maint and constr resource response	McHenry County TMC
McHenry County Maintenance	roadway maintenance status	McHenry County TMC
McHenry County TMC	maint and constr resource request	Lake County Highway Maintenance
McHenry County TMC	maint and constr resource request	McHenry County Maintenance
McHenry County TMC	maint and constr resource request	Private Sector Maintenance Contractor
Municipal Public Safety Dispatch	maint and constr resource request	IDOT District 1 Maintenance Management
Municipal Public Safety Dispatch	maint and constr resource request	Lake County Highway Construction
Municipal TMCs	maint and constr resource request	DuPage County Maintenance
Municipal TMCs	maint and constr resource request	Kane County Maintenance



Source	Flow Name	Destination
Municipal TMCs	maint and constr resource request	Municipal/ Township Maintenance
Municipal TMCs	maint and constr resource request	Will County Maintenance
Municipal/ Township Maintenance	maint and constr resource response	DuPage Area TMC
Municipal/ Township Maintenance	maint and constr resource response	DuPage County TMC
Municipal/ Township Maintenance	maint and constr resource response	IDOT District 1 Bureau of Traffic Signal Unit
Municipal/ Township Maintenance	roadway maintenance status	Kane County Maintenance
Municipal/ Township Maintenance	roadway maintenance status	Lake County Highway Maintenance
Municipal/ Township Maintenance	maint and constr resource response	Municipal TMCs
Municipal/ Township Maintenance	maint and constr resource response	Will County TMC
Private Sector Maintenance Contractor	maint and constr resource response	Cook County TMC
Private Sector Maintenance Contractor	maint and constr resource response	DuPage County TMC
Private Sector Maintenance Contractor	maint and constr resource response	IDOT District 1 Bureau of Traffic Signal Unit
Private Sector Maintenance Contractor	roadway maintenance status	IDOT District 1 Maintenance Management
Private Sector Maintenance Contractor	maint and constr resource response	Kane County TMC
Private Sector Maintenance Contractor	roadway maintenance status	Lake County Highway Maintenance
Private Sector Maintenance Contractor	maint and constr resource response	Lake County TMC
Private Sector Maintenance Contractor	maint and constr resource response	McHenry County TMC
Private Sector Maintenance Contractor	maint and constr resource response	Will County TMC
Satellite TMC OHare Airport	maint and constr resource request	Cook County Highway Department Maintenance Bureau
Utility Company Dispatch	maint and constr resource response	City of Chicago 911 Emergency Communications Center
Utility Company Dispatch	maint and constr resource response	DuPage County TMC
Weather Services	transportation weather information	City of Chicago Bureau of Street Operations Dispatch
Weather Services	transportation weather information	City of Chicago DOT BOS Roadway Maintenance
Weather Services	transportation weather information	City of Chicago DSS Traffic Services Dispatch
Weather Services	transportation weather information	Cook County Highway Department Maintenance Bureau
Weather Services	transportation weather information	DuPage County Maintenance
Weather Services	transportation weather information	IDOT District 1 Bureau of Construction
Weather Services	transportation weather information	IDOT District 1 ComCenter
Weather Services	transportation weather information	IDOT District 1 Maintenance Management
Weather Services	transportation weather information	ISTHA Maintenance and Construction
Weather Services	transportation weather information	Kane County Maintenance
Weather Services	transportation weather information	Lake County Highway Maintenance
Weather Services	transportation weather information	McHenry County Maintenance
Weather Services	transportation weather information	Municipal/ Township Maintenance
Weather Services	transportation weather information	Will County Maintenance
Will County Maintenance	maint and constr resource response	IDOT District 1 Bureau of Traffic Signal Unit
Will County Maintenance	roadway maintenance status	IDOT District 1 Maintenance Management
Will County Maintenance	maint and constr resource response	Illinois State Police Dispatch (Districts 2, 5 and Chicago)
Will County Maintenance	roadway maintenance status	Illinois State Police Dispatch (Districts 2, 5 and Chicago)
Will County Maintenance	maint and constr resource response	Municipal TMCs

Source	Flow Name	Destination
Will County Maintenance	maint and constr resource response	Will County TMC
Will County TMC	maint and constr resource request	IDOT District 1 Bureau of Construction
Will County TMC	maint and constr resource request	IDOT District 1 Maintenance Management
Will County TMC	maint and constr resource request	ISTHA Maintenance and Construction
Will County TMC	maint and constr resource request	Municipal/ Township Maintenance
Will County TMC	maint and constr resource request	Private Sector Maintenance Contractor
Will County TMC	maint and constr resource request	Will County Maintenance
WsDOT District 2 Traffic Operations Center	road network conditions	IDOT District 1 ComCenter

Source	Flow Name	Destination
Borman Traffic Management Center	road network conditions	IDOT District 1 ComCenter
City of Chicago 911 Emergency Communications Center	maint and constr resource request	City of Chicago DSS BOE Signal Maintenance
City of Chicago 911 Emergency Communications Center	maint and constr resource request	Utility Company Dispatch
City of Chicago Bureau of Street Operations Dispatch	maint and constr resource response	City of Chicago 911 Emergency Communications Center
City of Chicago DOT BOS Roadway Maintenance	maint and constr resource response	IDOT District 1 Bureau of Traffic Signal Unit
City of Chicago DOT TMC	maint and constr resource request	City of Chicago DSS Traffic Services Dispatch
City of Chicago DOT TMC	maint and constr resource request	IDOT District 1 ComCenter
City of Chicago DOT TMC	maint and constr resource request	IDOT District 1 Maintenance Management
City of Chicago DSS BOE Signal Maintenance	maint and constr resource response	City of Chicago 911 Emergency Communications Center
City of Chicago DSS BOE Signal Maintenance	maint and constr resource response	City of Chicago DOT TMC
City of Chicago DSS BOE Signal Maintenance	maint and constr resource response	IDOT District 1 Bureau of Traffic Signal Unit
City of Chicago DSS Traffic Services Dispatch	maint and constr resource response	City of Chicago DOT TMC
City of Chicago DSS Traffic Services Dispatch	maint and constr resource response	City of Chicago Skyway Operations
City of Chicago DSS Traffic Services Dispatch	maint and constr resource response	Private Tow and Recovery Operations
City of Chicago Skyway Operations	maint and constr resource request	City of Chicago DSS Traffic Services Dispatch
City of Chicago Skyway Operations	maint and constr resource request	IDOT District 1 ComCenter
City of Chicago Skyway Operations	road network conditions	IDOT District 1 ComCenter
Cook County Highway Department Construction Bureau	maint and constr resource response	City of Chicago DOT TMC
Cook County Highway Department Construction Bureau	maint and constr resource response	IDOT District 1 Bureau of Traffic Signal Unit
Cook County Highway Department Maintenance Bureau	maint and constr resource response	City of Chicago DOT TMC
Cook County Highway Department Maintenance Bureau	equipment maintenance status	Cook County TMC
Cook County Highway Department Maintenance Bureau	maint and constr resource response	Cook County TMC
Cook County Highway Department Maintenance Bureau	equipment maintenance status	IDOT District 1 Traffic Systems Center (TSC)
Cook County Highway Department Maintenance Bureau	maint and constr resource response	IDOT District 1 Traffic Systems Center (TSC)
Cook County Highway Department Maintenance Bureau	maint and constr resource response	Illinois State Police Dispatch (Districts 2, 5 and Chicago)
Cook County Highway Department Maintenance Bureau	maint and constr resource response	Kane County TMC
Cook County Highway Department Maintenance Bureau	maint and constr resource response	Lake County TMC
Cook County Highway Department Maintenance Bureau	maint and constr resource response	Satellite TMC OHare Airport
Cook County Sheriff Communications Center	maint and constr resource request	IDOT District 1 Maintenance Management
Cook County TMC	field equipment status	Cook County Highway Department Maintenance Bureau
Cook County TMC	maint and constr resource request	Cook County Highway Department Maintenance Bureau
Cook County TMC	maint and constr resource request	IDOT District 1 Maintenance Management
Cook County TMC	maint and constr resource request	Kane County Maintenance
Cook County TMC	maint and constr resource request	Lake County Highway Maintenance
Cook County TMC	maint and constr resource request	Private Sector Maintenance Contractor
DuPage Area TMC	field equipment status	Municipal/ Township Maintenance
DuPage Area TMC	maint and constr resource request	Municipal/ Township Maintenance
DuPage Area TMC	road network conditions	Municipal/ Township Maintenance
DuPage County EOC	maint and constr resource request	DuPage County Maintenance
DuPage County Maintenance	maint and constr resource response	DuPage County EOC
DuPage County Maintenance	equipment maintenance status	DuPage County TMC

Source	Flow Name	Destination
DuPage County Maintenance	maint and constr resource response	DuPage County TMC
DuPage County Maintenance	equipment maintenance status	IDOT District 1 Traffic Systems Center (TSC)
DuPage County Maintenance	maint and constr resource response	IDOT District 1 Traffic Systems Center (TSC)
DuPage County Maintenance	maint and constr resource response	Illinois State Police Dispatch (Districts 2, 5 and Chicago)
DuPage County Maintenance	maint and constr resource response	Kane County EOC
DuPage County Maintenance	maint and constr resource response	Kane County TMC
DuPage County Maintenance	maint and constr resource response	Municipal TMCs
DuPage County Roadside Equipment	field device status	DuPage County Maintenance
DuPage County Sheriff Communications Center	maint and constr resource request	IDOT District 1 Maintenance Management
DuPage County TMC	field equipment status	DuPage County Maintenance
DuPage County TMC	maint and constr resource request	DuPage County Maintenance
DuPage County TMC	maint and constr resource request	IDOT District 1 ComCenter
DuPage County TMC	maint and constr resource request	IDOT District 1 Maintenance Management
DuPage County TMC	maint and constr resource request	Municipal/ Township Maintenance
DuPage County TMC	maint and constr resource request	Private Sector Maintenance Contractor
DuPage County TMC	maint and constr resource request	Utility Company Dispatch
DuPage County TMC	road network conditions	Will County Maintenance
IDOT District 1 Bureau of Construction	storage facility request	IDOT District 1 Maintenance Yards
IDOT District 1 Bureau of Construction	maint and constr resource response	ISTHA TMC (TIMS)
IDOT District 1 Bureau of Construction	maint and constr resource response	Will County TMC
IDOT District 1 Bureau of Traffic Signal Unit	maint and constr resource request	City of Chicago DOT BOS Roadway Maintenance
IDOT District 1 Bureau of Traffic Signal Unit	maint and constr resource request	City of Chicago DSS BOE Signal Maintenance
IDOT District 1 Bureau of Traffic Signal Unit	maint and constr resource request	Cook County Highway Department Construction Bureau
IDOT District 1 Bureau of Traffic Signal Unit	maint and constr resource request	Cook County Highway Department Maintenance Bureau
IDOT District 1 Bureau of Traffic Signal Unit	road network conditions	IDOT District 1 ComCenter
IDOT District 1 Bureau of Traffic Signal Unit	maint and constr resource request	ISTHA Maintenance and Construction
IDOT District 1 Bureau of Traffic Signal Unit	maint and constr resource request	Kane County Maintenance
IDOT District 1 Bureau of Traffic Signal Unit	maint and constr resource request	Lake County Highway Maintenance
IDOT District 1 Bureau of Traffic Signal Unit	maint and constr resource request	McHenry County Maintenance
IDOT District 1 Bureau of Traffic Signal Unit	maint and constr resource request	Municipal/ Township Maintenance
IDOT District 1 Bureau of Traffic Signal Unit	maint and constr resource request	Private Sector Maintenance Contractor
IDOT District 1 Bureau of Traffic Signal Unit	maint and constr resource request	Will County Maintenance
IDOT District 1 Bureau of Traffic Signal Unit Roadside	field device status	IDOT District 1 Maintenance Management
IDOT District 1 ComCenter	maint and constr resource response	City of Chicago DOT TMC
IDOT District 1 ComCenter	maint and constr resource response	City of Chicago Skyway Operations
IDOT District 1 ComCenter	maint and constr resource response	DuPage County TMC
IDOT District 1 ComCenter	storage facility request	IDOT District 1 Maintenance Yards
IDOT District 1 ComCenter	maint and constr dispatch information	IDOT Maintenance Vehicles
IDOT District 1 ComCenter	maint and constr vehicle system control	IDOT Maintenance Vehicles
IDOT District 1 ComCenter	maint and constr resource response	Illinois State Police District 15 Operations Desk
IDOT District 1 ComCenter	maint and constr resource response	ISTHA TMC (TIMS)

Source	Flow Name	Destination
IDOT District 1 ComCenter Roadside Equipment	field device status	IDOT District 1 Maintenance Management
IDOT District 1 Maintenance Management	maint and constr resource response	City of Chicago DOT TMC
IDOT District 1 Maintenance Management	maint and constr resource response	Cook County Sheriff Communications Center
IDOT District 1 Maintenance Management	equipment maintenance status	Cook County TMC
IDOT District 1 Maintenance Management	maint and constr resource response	Cook County TMC
IDOT District 1 Maintenance Management	maint and constr resource response	DuPage County Sheriff Communications Center
IDOT District 1 Maintenance Management	equipment maintenance status	DuPage County TMC
IDOT District 1 Maintenance Management	maint and constr resource response	DuPage County TMC
IDOT District 1 Maintenance Management	storage facility request	IDOT District 1 Maintenance Yards
IDOT District 1 Maintenance Management	maint and constr dispatch information	IDOT Maintenance Vehicles
IDOT District 1 Maintenance Management	maint and constr resource response	Illinois State Police Dispatch (Districts 2, 5 and Chicago)
IDOT District 1 Maintenance Management	maint and constr resource response	Illinois State Police District 15 Operations Desk
IDOT District 1 Maintenance Management	maint and constr resource response	ISTHA TMC (TIMS)
IDOT District 1 Maintenance Management	maint and constr resource response	Lake County TMC
IDOT District 1 Maintenance Management	maint and constr resource response	Municipal Public Safety Dispatch
IDOT District 1 Maintenance Management	maint and constr resource response	Will County TMC
IDOT District 1 Maintenance Yards	equipment availability	IDOT District 1 Bureau of Construction
IDOT District 1 Maintenance Yards	equipment availability	IDOT District 1 ComCenter
IDOT District 1 Maintenance Yards	maintenance materials storage status	IDOT District 1 ComCenter
IDOT District 1 Maintenance Yards	equipment availability	IDOT District 1 Maintenance Management
IDOT District 1 Maintenance Yards	maintenance materials storage status	IDOT District 1 Maintenance Management
IDOT District 1 Maintenance Yards	equipment availability	Lake County Highway Maintenance
IDOT District 1 Maintenance Yards	maintenance materials storage status	Lake County Highway Maintenance
IDOT District 1 Traffic Systems Center (TSC)	field equipment status	Cook County Highway Department Maintenance Bureau
IDOT District 1 Traffic Systems Center (TSC)	maint and constr resource request	Cook County Highway Department Maintenance Bureau
IDOT District 1 Traffic Systems Center (TSC)	field equipment status	DuPage County Maintenance
IDOT District 1 Traffic Systems Center (TSC)	maint and constr resource request	DuPage County Maintenance
IDOT District 1 Traffic Systems Center (TSC)	maint and constr resource request	ISTHA Maintenance and Construction
IDOT District 1 Traffic Systems Center Roadside Equipment	field device status	IDOT District 1 Maintenance Management
IDOT Maintenance Vehicles	maint and constr dispatch status	IDOT District 1 ComCenter
IDOT Maintenance Vehicles	maint and constr vehicle operational data	IDOT District 1 ComCenter
IDOT Maintenance Vehicles	maint and constr dispatch status	IDOT District 1 Maintenance Management
IDOT Maintenance Vehicles	maint and constr vehicle operational data	IDOT District 1 Maintenance Management
Illinois State Police Dispatch (Districts 2, 5 and Chicago)	maint and constr resource request	Cook County Highway Department Maintenance Bureau
Illinois State Police Dispatch (Districts 2, 5 and Chicago)	maint and constr resource request	DuPage County Maintenance
Illinois State Police Dispatch (Districts 2, 5 and Chicago)	maint and constr resource request	IDOT District 1 Maintenance Management
Illinois State Police Dispatch (Districts 2, 5 and Chicago)	maint and constr resource request	Kane County Maintenance
Illinois State Police Dispatch (Districts 2, 5 and Chicago)	maint and constr resource request	Lake County Highway Maintenance
Illinois State Police Dispatch (Districts 2, 5 and Chicago)	maint and constr resource request	McHenry County Maintenance
Illinois State Police Dispatch (Districts 2, 5 and Chicago)	maint and constr resource request	Will County Maintenance
Illinois State Police District 15 Operations Desk	maint and constr resource request	IDOT District 1 ComCenter

Source	Flow Name	Destination
Illinois State Police District 15 Operations Desk	maint and constr resource request	IDOT District 1 Maintenance Management
Illinois State Police District 15 Operations Desk	maint and constr resource request	ISTHA Maintenance and Construction
ISTHA Dispatch Center	maint and constr resource request	ISTHA Maintenance and Construction
ISTHA Maintenance and Construction	maint and constr resource response	IDOT District 1 Bureau of Traffic Signal Unit
ISTHA Maintenance and Construction	maint and constr resource response	IDOT District 1 Traffic Systems Center (TSC)
ISTHA Maintenance and Construction	maint and constr resource response	Illinois State Police District 15 Operations Desk
ISTHA Maintenance and Construction	maint and constr resource response	ISTHA Dispatch Center
ISTHA Maintenance and Construction	maint and constr resource response	Lake County TMC
ISTHA Maintenance and Construction	maint and constr resource response	Will County TMC
ISTHA TMC (TIMS)	maint and constr resource request	IDOT District 1 Bureau of Construction
ISTHA TMC (TIMS)	maint and constr resource request	IDOT District 1 ComCenter
ISTHA TMC (TIMS)	maint and constr resource request	IDOT District 1 Maintenance Management
ISTHA TMC (TIMS)	field equipment status	ISTHA Maintenance and Construction
Kane County EOC	maint and constr resource request	DuPage County Maintenance
Kane County EOC	maint and constr resource request	Kane County Maintenance
Kane County Maintenance	maint and constr resource response	IDOT District 1 Bureau of Traffic Signal Unit
Kane County Maintenance	maint and constr resource response	Illinois State Police Dispatch (Districts 2, 5 and Chicago)
Kane County Maintenance	maint and constr resource response	Kane County EOC
Kane County Maintenance	equipment maintenance status	Kane County TMC
Kane County Maintenance	maint and constr resource response	Kane County TMC
Kane County Maintenance	maint and constr resource response	Municipal TMCs
Kane County TMC	maint and constr resource request	Cook County Highway Department Maintenance Bureau
Kane County TMC	road network conditions	Cook County Highway Department Maintenance Bureau
Kane County TMC	maint and constr resource request	DuPage County Maintenance
Kane County TMC	road network conditions	DuPage County Maintenance
Kane County TMC	field equipment status	Kane County Maintenance
Kane County TMC	maint and constr resource request	Kane County Maintenance
Kane County TMC	road network conditions	Kane County Maintenance
Kane County TMC	maint and constr resource request	McHenry County Maintenance
Kane County TMC	maint and constr resource request	Private Sector Maintenance Contractor
Lake County Communications Center	maint and constr resource request	Lake County Highway Construction
Lake County Communications Center	maint and constr resource request	Lake County Highway Maintenance
Lake County Highway Construction	maint and constr resource response	Lake County Communications Center
Lake County Highway Construction	maint and constr resource response	Lake County TMC
Lake County Highway Construction	maint and constr resource response	Municipal Public Safety Dispatch
Lake County Highway Maintenance	maint and constr resource response	IDOT District 1 Bureau of Traffic Signal Unit
Lake County Highway Maintenance	storage facility request	IDOT District 1 Maintenance Yards
Lake County Highway Maintenance	maint and constr resource response	Illinois State Police Dispatch (Districts 2, 5 and Chicago)
Lake County Highway Maintenance	maint and constr resource response	Lake County Communications Center
Lake County Highway Maintenance	equipment maintenance status	Lake County TMC
Lake County Highway Maintenance	maint and constr resource response	Lake County TMC

Source	Flow Name	Destination
Lake County Highway Maintenance	maint and constr resource response	McHenry County TMC
Lake County Highway Maintenance	maint and constr resource response	Municipal Public Safety Dispatch
Lake County TMC	maint and constr resource request	Cook County Highway Department Maintenance Bureau
Lake County TMC	road network conditions	Cook County Highway Department Maintenance Bureau
Lake County TMC	maint and constr resource request	IDOT District 1 ComCenter
Lake County TMC	road network conditions	IDOT District 1 ComCenter
Lake County TMC	maint and constr resource request	IDOT District 1 Maintenance Management
Lake County TMC	maint and constr resource request	ISTHA Maintenance and Construction
Lake County TMC	maint and constr resource request	Lake County Highway Construction
Lake County TMC	field equipment status	Lake County Highway Maintenance
Lake County TMC	maint and constr resource request	Lake County Highway Maintenance
Lake County TMC	road network conditions	Lake County Highway Maintenance
Lake County TMC	maint and constr resource request	McHenry County Maintenance
Lake County TMC	maint and constr resource request	Private Sector Maintenance Contractor
McHenry County EOC	maint and constr resource request	McHenry County Maintenance
McHenry County Maintenance	maint and constr resource response	IDOT District 1 Bureau of Traffic Signal Unit
McHenry County Maintenance	maint and constr resource response	Illinois State Police Dispatch (Districts 2, 5 and Chicago)
McHenry County Maintenance	maint and constr resource response	Lake County TMC
McHenry County Maintenance	maint and constr resource response	McHenry County EOC
McHenry County Maintenance	equipment maintenance status	McHenry County TMC
McHenry County Maintenance	maint and constr resource response	McHenry County TMC
McHenry County TMC	maint and constr resource request	Lake County Highway Maintenance
McHenry County TMC	field equipment status	McHenry County Maintenance
McHenry County TMC	maint and constr resource request	McHenry County Maintenance
McHenry County TMC	maint and constr resource request	Private Sector Maintenance Contractor
Municipal Public Safety Dispatch	maint and constr resource request	IDOT District 1 Maintenance Management
Municipal Public Safety Dispatch	maint and constr resource request	Lake County Highway Construction
Municipal TMCs	maint and constr resource request	DuPage County Maintenance
Municipal TMCs	maint and constr resource request	Kane County Maintenance
Municipal TMCs	maint and constr resource request	Municipal/ Township Maintenance
Municipal TMCs	maint and constr resource request	Will County Maintenance
Municipal/ Township Maintenance	equipment maintenance status	DuPage Area TMC
Municipal/ Township Maintenance	maint and constr resource response	DuPage Area TMC
Municipal/ Township Maintenance	maint and constr resource response	DuPage County TMC
Municipal/ Township Maintenance	maint and constr resource response	IDOT District 1 Bureau of Traffic Signal Unit
Municipal/ Township Maintenance	maint and constr resource response	Municipal TMCs
Municipal/ Township Maintenance	maint and constr resource response	Will County TMC
Private Sector Maintenance Contractor	maint and constr resource response	Cook County TMC
Private Sector Maintenance Contractor	maint and constr resource response	DuPage County TMC
Private Sector Maintenance Contractor	maint and constr resource response	IDOT District 1 Bureau of Traffic Signal Unit
Private Sector Maintenance Contractor	maint and constr resource response	Kane County TMC

Source	Flow Name	Destination
Private Sector Maintenance Contractor	maint and constr resource response	Lake County TMC
Private Sector Maintenance Contractor	maint and constr resource response	McHenry County TMC
Private Sector Maintenance Contractor	maint and constr resource response	Will County TMC
Satellite TMC OHare Airport	maint and constr resource request	Cook County Highway Department Maintenance Bureau
Utility Company Dispatch	maint and constr resource response	City of Chicago 911 Emergency Communications Center
Utility Company Dispatch	maint and constr resource response	DuPage County TMC
Weather Services	transportation weather information	City of Chicago Bureau of Street Operations Dispatch
Weather Services	transportation weather information	City of Chicago DOT BOS Roadway Maintenance
Weather Services	transportation weather information	City of Chicago DSS Traffic Services Dispatch
Weather Services	transportation weather information	Cook County Highway Department Maintenance Bureau
Weather Services	transportation weather information	DuPage County Maintenance
Weather Services	transportation weather information	IDOT District 1 Bureau of Construction
Weather Services	transportation weather information	IDOT District 1 ComCenter
Weather Services	transportation weather information	IDOT District 1 Maintenance Management
Weather Services	transportation weather information	ISTHA Maintenance and Construction
Weather Services	transportation weather information	Kane County Maintenance
Weather Services	transportation weather information	Lake County Highway Maintenance
Weather Services	transportation weather information	McHenry County Maintenance
Weather Services	transportation weather information	Municipal/ Township Maintenance
Weather Services	transportation weather information	Will County Maintenance
Will County Maintenance	maint and constr resource response	IDOT District 1 Bureau of Traffic Signal Unit
Will County Maintenance	maint and constr resource response	Illinois State Police Dispatch (Districts 2, 5 and Chicago)
Will County Maintenance	maint and constr resource response	Municipal TMCs
Will County Maintenance	equipment maintenance status	Will County TMC
Will County Maintenance	maint and constr resource response	Will County TMC
Will County TMC	maint and constr resource request	IDOT District 1 Bureau of Construction
Will County TMC	maint and constr resource request	IDOT District 1 Maintenance Management
Will County TMC	maint and constr resource request	ISTHA Maintenance and Construction
Will County TMC	maint and constr resource request	Municipal/ Township Maintenance
Will County TMC	maint and constr resource request	Private Sector Maintenance Contractor
Will County TMC	field equipment status	Will County Maintenance
Will County TMC	maint and constr resource request	Will County Maintenance
WsDOT District 2 Traffic Operations Center	road network conditions	IDOT District 1 ComCenter



Source	Flow Name	Destination
City of Chicago DOT BOS Roadway Maintenance	work plan coordination	Cook County Highway Department Construction Bureau
City of Chicago DOT BOS Roadway Maintenance	work plan coordination	Cook County Highway Department Maintenance Bureau
City of Chicago DOT BOS Roadway Maintenance	work plan coordination	IDOT District 1 Bureau of Traffic- Expressway Operations Unit
City of Chicago DOT BOS Roadway Maintenance	current asset restrictions	Independent School District Dispatch
City of Chicago DOT BOS Roadway Maintenance	maint and constr work plans	Independent School District Dispatch
City of Chicago DOT TMC	work plan feedback	IDOT District 1 Maintenance Management
City of Chicago DSS BOE Signal Maintenance	work plan coordination	City of Chicago DOT BOS Roadway Maintenance
City of Chicago DSS BOE Signal Maintenance	maint and constr work plans	City of Chicago DOT TMC
City of Chicago DSS BOE Signal Maintenance	work plan coordination	Cook County Highway Department Maintenance Bureau
Cook County Highway Department Construction Bureau	maint and constr work plans	Chicago Transit Authority Paratransit Dispatch
Cook County Highway Department Construction Bureau	work plan coordination	City of Chicago DOT BOS Roadway Maintenance
Cook County Highway Department Construction Bureau	maint and constr work plans	City of Chicago DOT TMC
Cook County Highway Department Construction Bureau	work plan coordination	Lake County Highway Construction
Cook County Highway Department Maintenance Bureau	maint and constr work plans	Chicago Transit Authority Paratransit Dispatch
Cook County Highway Department Maintenance Bureau	work plan coordination	City of Chicago DOT BOS Roadway Maintenance
Cook County Highway Department Maintenance Bureau	maint and constr work plans	City of Chicago DOT TMC
Cook County Highway Department Maintenance Bureau	work plan coordination	City of Chicago DSS BOE Signal Maintenance
Cook County Highway Department Maintenance Bureau	work plan coordination	DuPage County Maintenance
Cook County Highway Department Maintenance Bureau	maint and constr work plans	IDOT District 1 ComCenter
Cook County Highway Department Maintenance Bureau	work plan coordination	IDOT District 1 Maintenance Management
Cook County Highway Department Maintenance Bureau	current asset restrictions	Independent School District Dispatch
Cook County Highway Department Maintenance Bureau	maint and constr work plans	Independent School District Dispatch
Cook County Highway Department Maintenance Bureau	work plan coordination	Kane County Maintenance
Cook County Highway Department Maintenance Bureau	maint and constr work plans	Kane County TMC
Cook County Highway Department Maintenance Bureau	work plan coordination	Lake County Highway Maintenance
Cook County Highway Department Maintenance Bureau	maint and constr work plans	Rail Freight Operations
Cook County TMC	work plan feedback	Cook County Highway Department Maintenance Bureau
Cook County TMC	work plan feedback	Lake County Highway Maintenance
DuPage County Maintenance	maint and constr work plans	Chicago Transit Authority Control Center
DuPage County Maintenance	maint and constr work plans	Chicago Transit Authority Paratransit Dispatch
DuPage County Maintenance	work plan coordination	Cook County Highway Department Maintenance Bureau
DuPage County Maintenance	maint and constr work plans	DuPage Centralized Paratransit Dispatch
DuPage County Maintenance	maint and constr work plans	DuPage County EOC
DuPage County Maintenance	current asset restrictions	DuPage County TMC
DuPage County Maintenance	maint and constr work plans	DuPage County TMC
DuPage County Maintenance	work plan coordination	IDOT District 1 Bureau of Construction
DuPage County Maintenance	work plan coordination	IDOT District 1 Bureau of Traffic- Expressway Operations Unit
DuPage County Maintenance	work plan coordination	IDOT District 1 Maintenance Management
DuPage County Maintenance	current asset restrictions	Independent School District Dispatch
DuPage County Maintenance	maint and constr work plans	Independent School District Dispatch

Source	Flow Name	Destination
DuPage County Maintenance	work plan coordination	ISTHA Maintenance and Construction
DuPage County Maintenance	work plan coordination	Kane County Maintenance
DuPage County Maintenance	maint and constr work plans	Kane County TMC
DuPage County Maintenance	maint and constr work plans	Municipal Public Safety Dispatch
DuPage County Maintenance	work plan coordination	Private Sector Maintenance Contractor
DuPage County Maintenance	maint and constr work plans	Rail Freight Operations
DuPage County Maintenance	work plan feedback	Rail Freight Operations
DuPage County Maintenance	maint and constr work plans	Satellite TMC OHare Airport
DuPage County Maintenance	work plan coordination	Will County Maintenance
DuPage County TMC	work plan feedback	DuPage County Maintenance
IDOT District 1 Bureau of Construction	work plan coordination	City of Chicago DOT BOS Roadway Maintenance
IDOT District 1 Bureau of Construction	maint and constr work plans	City of Chicago DOT TMC
IDOT District 1 Bureau of Construction	work plan coordination	Cook County Highway Department Maintenance Bureau
IDOT District 1 Bureau of Construction	work plan coordination	DuPage County Maintenance
IDOT District 1 Bureau of Construction	work plan coordination	IDOT District 1 Bureau of Traffic- Expressway Operations Unit
IDOT District 1 Bureau of Construction	maint and constr work plans	IDOT District 1 ComCenter
IDOT District 1 Bureau of Construction	work plan coordination	IDOT District 1 Maintenance Management
IDOT District 1 Bureau of Construction	work plan coordination	ISTHA Maintenance and Construction
IDOT District 1 Bureau of Construction	work plan coordination	Lake County Highway Construction
IDOT District 1 Bureau of Construction	maint and constr work plans	Media
IDOT District 1 Bureau of Construction	maint and constr work plans	Metra Consolidated Control Facility
IDOT District 1 Bureau of Traffic- Expressway Operations Unit	maint and constr work plans	Borman Traffic Management Center
IDOT District 1 Bureau of Traffic- Expressway Operations Unit	maint and constr work plans	City of Chicago 911 Emergency Communications Center
IDOT District 1 Bureau of Traffic- Expressway Operations Unit	work plan coordination	City of Chicago DOT BOS Roadway Maintenance
IDOT District 1 Bureau of Traffic- Expressway Operations Unit	maint and constr work plans	City of Chicago DOT TMC
IDOT District 1 Bureau of Traffic- Expressway Operations Unit	maint and constr work plans	Cook County Sheriff Communications Center
IDOT District 1 Bureau of Traffic- Expressway Operations Unit	maint and constr work plans	Cook County TMC
IDOT District 1 Bureau of Traffic- Expressway Operations Unit	maint and constr work plans	DuPage County Sheriff Communications Center
IDOT District 1 Bureau of Traffic- Expressway Operations Unit	maint and constr work plans	DuPage County TMC
IDOT District 1 Bureau of Traffic- Expressway Operations Unit	maint and constr work plans	IDOT District 1 Bureau of Traffic Signal Unit
IDOT District 1 Bureau of Traffic- Expressway Operations Unit	maint and constr work plans	IDOT District 1 ComCenter
IDOT District 1 Bureau of Traffic- Expressway Operations Unit	work plan coordination	IDOT District 1 Maintenance Management
IDOT District 1 Bureau of Traffic- Expressway Operations Unit	maint and constr work plans	IDOT District 1 Traffic Systems Center (TSC)
IDOT District 1 Bureau of Traffic- Expressway Operations Unit	maint and constr work plans	Illinois State Police Dispatch (Districts 2, 5 and Chicago)
IDOT District 1 Bureau of Traffic- Expressway Operations Unit	maint and constr work plans	Independent School District Dispatch
IDOT District 1 Bureau of Traffic- Expressway Operations Unit	maint and constr work plans	Municipal Public Safety Dispatch
IDOT District 1 Bureau of Traffic- Expressway Operations Unit	work plan coordination	Will County Maintenance
IDOT District 1 ComCenter	maint and constr work plans	Chicago Transit Authority Control Center
IDOT District 1 ComCenter	maint and constr work plans	Chicago Transit Authority Paratransit Dispatch
IDOT District 1 ComCenter	maint and constr work plans	City of Chicago DOT TMC

Source	Flow Name	Destination
IDOT District 1 ComCenter	work plan coordination	Cook County Highway Department Maintenance Bureau
IDOT District 1 ComCenter	maint and constr work plans	DuPage County TMC
IDOT District 1 ComCenter	current asset restrictions	Independent School District Dispatch
IDOT District 1 ComCenter	maint and constr work plans	Independent School District Dispatch
IDOT District 1 Maintenance Management	work plan coordination	City of Chicago DOT BOS Roadway Maintenance
IDOT District 1 Maintenance Management	maint and constr work plans	City of Chicago DOT TMC
IDOT District 1 Maintenance Management	work plan coordination	Cook County Highway Department Maintenance Bureau
IDOT District 1 Maintenance Management	maint and constr work plans	Cook County TMC
IDOT District 1 Maintenance Management	work plan coordination	DuPage County Maintenance
IDOT District 1 Maintenance Management	maint and constr work plans	DuPage County TMC
IDOT District 1 Maintenance Management	work plan coordination	IDOT District 1 Bureau of Construction
IDOT District 1 Maintenance Management	maint and constr work plans	IDOT District 1 Bureau of Traffic Signal Unit
IDOT District 1 Maintenance Management	maint and constr work plans	IDOT District 1 ComCenter
IDOT District 1 Maintenance Management	maint and constr work plans	IDOT District 1 Traffic Systems Center (TSC)
IDOT District 1 Maintenance Management	maint and constr work plans	Illinois Gateway
IDOT District 1 Maintenance Management	maint and constr work plans	Illinois State Police Dispatch (Districts 2, 5 and Chicago)
IDOT District 1 Maintenance Management	work plan coordination	Kane County Maintenance
IDOT District 1 Maintenance Management	work plan coordination	Lake County Highway Maintenance
IDOT District 1 Maintenance Management	work plan coordination	McHenry County Maintenance
IDOT District 1 Maintenance Management	maint and constr work plans	McHenry County TMC
IDOT District 1 Maintenance Management	maint and constr work plans	Media
IDOT District 1 Maintenance Management	maint and constr work plans	Metra Consolidated Control Facility
IDOT District 1 Maintenance Management	maint and constr work plans	Rail Freight Operations
IDOT District 1 Maintenance Management	work plan coordination	Will County Maintenance
IDOT District 1 Traffic Systems Center (TSC)	work plan feedback	Cook County Highway Department Maintenance Bureau
IDOT District 1 Traffic Systems Center (TSC)	work plan feedback	DuPage County Maintenance
IDOT District 1 Traffic Systems Center (TSC)	work plan feedback	ISTHA Maintenance and Construction
Illinois Gateway	work plan feedback	IDOT District 1 ComCenter
ISTHA Maintenance and Construction	work plan coordination	DuPage County Maintenance
ISTHA Maintenance and Construction	maint and constr work plans	ISTHA Dispatch Center
ISTHA Maintenance and Construction	work plan coordination	Kenosha County Highway Maintenance
ISTHA Maintenance and Construction	work plan coordination	Lake County Highway Construction
ISTHA Maintenance and Construction	work plan coordination	Lake County Highway Maintenance
ISTHA Maintenance and Construction	work plan coordination	McHenry County Maintenance
ISTHA TMC (TIMS)	work plan feedback	ISTHA Maintenance and Construction
Kane County Maintenance	work plan coordination	Cook County Highway Department Maintenance Bureau
Kane County Maintenance	work plan coordination	DuPage County Maintenance
Kane County Maintenance	maint and constr work plans	IDOT District 1 ComCenter
Kane County Maintenance	work plan coordination	IDOT District 1 ComCenter
Kane County Maintenance	work plan coordination	IDOT District 1 Maintenance Management

Source	Flow Name	Destination
Kane County Maintenance	current asset restrictions	Illinois State Police Dispatch (Districts 2, 5 and Chicago)
Kane County Maintenance	maint and constr work plans	Illinois State Police Dispatch (Districts 2, 5 and Chicago)
Kane County Maintenance	current asset restrictions	Kane County EOC
Kane County Maintenance	maint and constr work plans	Kane County EOC
Kane County Maintenance	current asset restrictions	Kane County TMC
Kane County Maintenance	maint and constr work plans	Kane County TMC
Kane County Maintenance	maint and constr work plans	McHenry County EOC
Kane County Maintenance	work plan coordination	McHenry County Maintenance
Kane County Maintenance	current asset restrictions	McHenry County TMC
Kane County Maintenance	maint and constr work plans	McHenry County TMC
Kane County Maintenance	maint and constr work plans	Media
Kane County Maintenance	work plan coordination	Municipal/ Township Maintenance
Kane County Maintenance	work plan coordination	Private Sector Maintenance Contractor
Kane County Maintenance	maint and constr work plans	Rail Freight Operations
Kane County TMC	work plan feedback	Cook County Highway Department Maintenance Bureau
Kane County TMC	work plan feedback	DuPage County Maintenance
Kane County TMC	work plan feedback	Kane County Maintenance
Kenosha County Highway Maintenance	work plan coordination	ISTHA Maintenance and Construction
Kenosha County Highway Maintenance	work plan coordination	Lake County Highway Maintenance
Lake County Communications Center	work plan feedback	Lake County Highway Construction
Lake County Communications Center	work plan feedback	Lake County Highway Maintenance
Lake County Highway Construction	work plan coordination	Cook County Highway Department Construction Bureau
Lake County Highway Construction	work plan coordination	IDOT District 1 Bureau of Construction
Lake County Highway Construction	work plan coordination	ISTHA Maintenance and Construction
Lake County Highway Construction	maint and constr work plans	Lake County Communications Center
Lake County Highway Construction	work plan coordination	Lake County Highway Maintenance
Lake County Highway Construction	maint and constr work plans	Lake County TMC
Lake County Highway Construction	maint and constr work plans	Municipal Public Safety Dispatch
Lake County Highway Maintenance	work plan coordination	Cook County Highway Department Maintenance Bureau
Lake County Highway Maintenance	work plan coordination	IDOT District 1 Maintenance Management
Lake County Highway Maintenance	work plan coordination	ISTHA Maintenance and Construction
Lake County Highway Maintenance	work plan coordination	Kenosha County Highway Maintenance
Lake County Highway Maintenance	maint and constr work plans	Lake County Communications Center
Lake County Highway Maintenance	work plan coordination	Lake County Highway Construction
Lake County Highway Maintenance	current asset restrictions	Lake County TMC
Lake County Highway Maintenance	maint and constr work plans	Lake County TMC
Lake County Highway Maintenance	work plan coordination	McHenry County Maintenance
Lake County Highway Maintenance	maint and constr work plans	McHenry County TMC
Lake County Highway Maintenance	maint and constr work plans	Media
Lake County Highway Maintenance	maint and constr work plans	Municipal Public Safety Dispatch

Source	Flow Name	Destination
Lake County Highway Maintenance	work plan coordination	Municipal/ Township Maintenance
Lake County Highway Maintenance	work plan coordination	Private Sector Maintenance Contractor
Lake County Highway Maintenance	maint and constr work plans	Rail Freight Operations
Lake County TMC	work plan feedback	Cook County Highway Department Maintenance Bureau
Lake County TMC	work plan feedback	Lake County Highway Construction
Lake County TMC	work plan feedback	Lake County Highway Maintenance
McHenry County Maintenance	work plan coordination	IDOT District 1 Maintenance Management
McHenry County Maintenance	work plan coordination	Lake County Highway Maintenance
McHenry County Maintenance	current asset restrictions	McHenry County EOC
McHenry County Maintenance	maint and constr work plans	McHenry County EOC
McHenry County Maintenance	current asset restrictions	McHenry County TMC
McHenry County Maintenance	maint and constr work plans	McHenry County TMC
McHenry County Maintenance	maint and constr work plans	Rail Freight Operations
McHenry County TMC	work plan feedback	McHenry County Maintenance
Municipal/ Township Maintenance	work plan coordination	Kane County Maintenance
Municipal/ Township Maintenance	work plan coordination	Lake County Highway Maintenance
Private Sector Maintenance Contractor	work plan coordination	Lake County Highway Maintenance
Rail Freight Operations	railroad schedules	DuPage County Maintenance
Rail Freight Operations	work plan feedback	DuPage County Maintenance
Rail Freight Operations	railroad schedules	IDOT District 1 ComCenter
Utility Company Dispatch	maint and constr work plans	City of Chicago 911 Emergency Communications Center
Utility Company Dispatch	maint and constr work plans	City of Chicago DOT TMC
Utility Company Dispatch	maint and constr work plans	Cook County TMC
Utility Company Dispatch	maint and constr work plans	DuPage County TMC
Utility Company Dispatch	maint and constr work plans	IDOT District 1 Bureau of Traffic Signal Unit
Utility Company Dispatch	maint and constr work plans	IDOT District 1 ComCenter
Utility Company Dispatch	maint and constr work plans	Kane County TMC
Utility Company Dispatch	maint and constr work plans	Lake County TMC
Utility Company Dispatch	maint and constr work plans	McHenry County TMC
Utility Company Dispatch	maint and constr work plans	Will County TMC
Will County Maintenance	work plan coordination	IDOT District 1 Bureau of Traffic- Expressway Operations Unit
Will County Maintenance	work plan coordination	IDOT District 1 Maintenance Management